

**CARLO GAVAZZI**  
Automation Components

**80**   
**CARLO GAVAZZI**  
1931-2011



# Our Products



## Sense

Inductive sensors	8
Capacitive sensors	28
Conductive sensors	40
Ultrasonic sensors	44
Photoelectric sensors	50
Wind sensors	73
Motion and presence sensors	74
Light curtains for lift and doors	76
Magnetic sensors	79
Environmental sensors	86
Intrinsic safety	88
Safety magnetic sensors	89
Safety light curtains	90

## Switch

Solid state relays	96
Soft starters	115
Solid state relays accessories	120
Variable speed drives	123
Limit switches	127
Pilot lights	135
Push buttons	136
Electromechanical relays	138
Sockets and modules	141

## Control

Monitoring relays	144
Timers	154
Current transformers	160
Accessories and transducer	167
Digital panel meters	168
Energy management	172
Counters	181
PID controllers	184
Switching power supplies	186
Safety modules	192

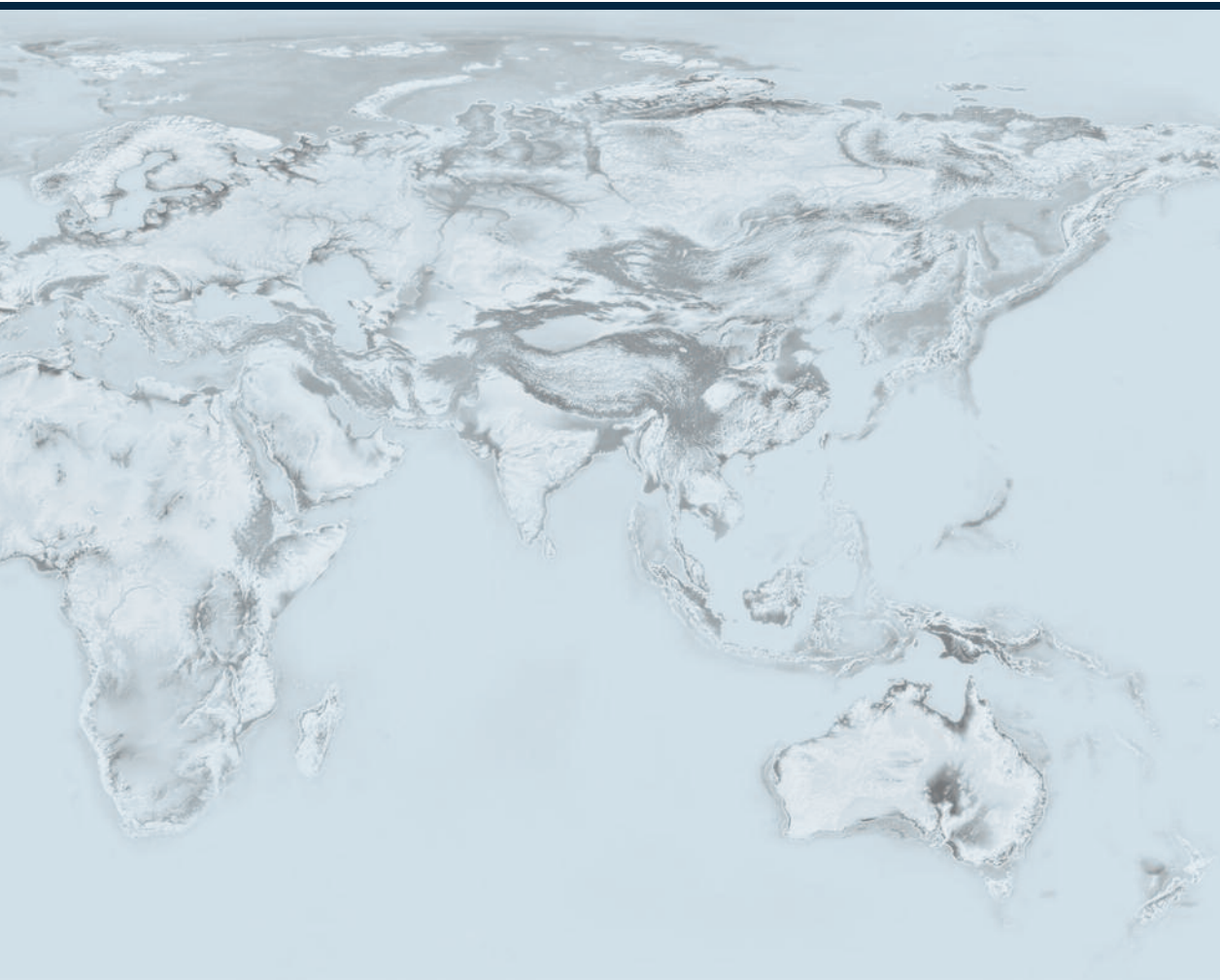

## Fieldbus

## EcoEnergy equipment

General purpose	198	Solar inverters	222
DuplineSafe	212	Solar control solution	225
Parking guidance system	214	Digital energy production display	229
Irrigation	217		
Elevator	218		



## A complete product range

Carlo Gavazzi Automation is a multinational electronics group active in the design, manufacture and marketing of electronic equipment targeted at the global markets of industrial automation, building automation and energy.

Our history is full of firsts and our products are installed in a huge number of applications all over the world. With 80 years of successful operation, our experience is unparalleled.

Our core competence in automation spans five product lines: Sense, Switch, Control, Fieldbus and EcoEnergy equipment.

Our wide array of products includes sensors, monitoring relays, timers, solid-state relays, electronic motor controllers, energy management equipment, fieldbus systems and components for renewable energy.

We have our headquarters in Europe and numerous offices around the world. Our R&D competence centres and production sites are located in Denmark, Italy, Lithuania, Malta and the People's Republic of China. We operate worldwide through 21 wholly-owned sales companies and selected representatives in more than 65 countries, from the Pacific Rim in the East to the United States in the West.



## A guarantee of reliability

Carlo Gavazzi products earned the independent approval of the relevant bodies which govern our industry and the many markets we serve. They are developed and manufactured in full compliance with the most important international standard regulations.

Carlo Gavazzi manufacturing facilities operates in line with the requirements of ISO9001:2008 Quality Management Systems and ISO14001:2004 Environmental Management System standard.





# Sense







Inductive sensors	8
Capacitive sensors	28
Conductive sensors	40
Ultrasonic sensors	44
Photoelectric sensors	50
Wind sensors	73
Motion and presence sensors	74
Light curtains for lift and doors	76
Magnetic sensors	79
Environmental sensors	86
Intrinsic safety	88
Safety magnetic sensors	89
Safety light curtains	90

# Inductive proximity sensors, NAMUR, DC



Types	M12		M18	
Housing	Steel	Plastic	Steel	Plastic
<b>Flush mountable</b>				
Dimensions short body (mm)	M12 x 1 x 30	M12 x 1 x 30	M18 x 1 x 30	M18 x 1 x 30
Dimensions long body (mm)	M12 x 1 x 50	M12 x 1 x 50	M18 x 1 x 50	M18 x 1 x 50
Thread (mm)	M12 x 1	M12 x 1	M18 x 1	M18 x 1
Operating frequency	1.4 kHz	1.4 kHz	500 Hz	500 Hz
Sensing distance (Sn)	2 mm	2 mm	5 mm	5 mm
<b>References</b>				
Short body cable	<b>IA12ESF02UC</b>	<b>IA12CSF02UC</b>	<b>IA18ESF05UC</b>	<b>IA18CSF05UC</b>
Long body cable	<b>IA12ELF02UC</b>	<b>IA12CLF02UC</b>	<b>IA18ELF05UC</b>	<b>IA18CLF05UC</b>
Short body plug	<b>IA12ESF02UCM1</b>	<b>IA12CSF02UCM1</b>	<b>IA18ESF05UCM1</b>	<b>IA18CSF05UCM1</b>
Long body plug	<b>IA12ELF02UCM1</b>	<b>IA12CLF02UCM1</b>	<b>IA18ELF05UCM1</b>	<b>IA18CLF05UCM1</b>
<b>Non-flush mountable</b>				
Dimensions short body (mm)	M12 x 1 x 30	M12 x 1 x 30	M18 x 1 x 30	M18 x 1 x 30
Dimensions long body (mm)	M12 x 1 x 50	M12 x 1 x 50	M18 x 1 x 50	M18 x 1 x 50
Thread (mm)	M12 x 1	M12 x 1	M18 x 1	M18 x 1
Operating frequency	1.2 kHz	1.2 kHz	200 Hz	200 Hz
Sensing distance (Sn)	4 mm	4 mm	8 mm	8 mm
<b>References</b>				
Short body cable	<b>IA12ESN04UC</b>	<b>IA12CSN04UC</b>	<b>IA18ESN08UC</b>	<b>IA18CSN08UC</b>
Long body cable	<b>IA12ELN04UC</b>	<b>IA12CLN04UC</b>	<b>IA18ELN08UC</b>	<b>IA18CLN08UC</b>
Short body plug	<b>IA12ESN04UCM1</b>	<b>IA12CSN04UCM1</b>	<b>IA18ESN08UCM1</b>	<b>IA18CSN08UCM1</b>
Long body plug	<b>IA12ELN04UCM1</b>	<b>IA12CLN04UCM1</b>	<b>IA18ELN08UCM1</b>	<b>IA18CLN08UCM1</b>
<b>Characteristics flush and non-flush mountable</b>				
Rated operating voltage	7 - 9 VDC	7 - 9 VDC	7 - 9 VDC	7 - 9 VDC
Degree of protection	IP 67	IP 67	IP 67	IP 67
Housing material	Stainless steel	Thermoplastic polyester	Stainless steel	Thermoplastic polyester
Operating temperature	-25°C to +70°C	-25°C to +70°C	-25°C to +70°C	-25°C to +70°C
LED colour	Yellow	Yellow	Yellow	Yellow
Approvals/Marks	CE - UL - CSA	CE - UL - CSA	CE - UL - CSA	CE - UL - CSA



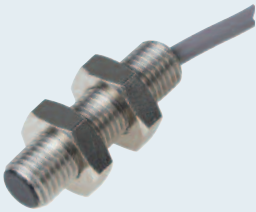

# Inductive proximity sensors, NAMUR, DC

Types	M30	
Connections	Steel	Plastic
<b>Flush mountable</b>		
Dimensions short body (mm)	M30 x 1.5 x 30	M30 x 1.5 x 30
Dimensions long body (mm)	M30 x 1.5 x 50	M30 x 1.5 x 50
Thread (mm)	M30 x 1	M30 x 1
Operating frequency	300 Hz	300 Hz
Sensing distance (Sn)	10 mm	10 mm
<b>References</b>		
Short body cable	<b>IA30ESF10UC</b>	<b>IA30CSF10UC</b>
Long body cable	<b>IA30ELF10UC</b>	<b>IA30CLF10UC</b>
Short body plug	<b>IA30ESF10UCM1</b>	<b>IA30CSF10UCM1</b>
Long body plug	<b>IA30ELF10UCM1</b>	<b>IA30CLF10UCM1</b>
<b>Non-flush mountable</b>		
Dimensions short body (mm)	M30 x 1.5 x 30	M30 x 1.5 x 30
Dimensions long body (mm)	M30 x 1.5 x 50	M30 x 1.5 x 50
Thread (mm)	M30 x 1.5	M30 x 1.5
Operating frequency	100 Hz	100 Hz
Sensing distance (Sn)	15 mm	15 mm
<b>References</b>		
NPN-NO	<b>IA30ESN15UC</b>	<b>IA30CSN15UC</b>
PNP-NO	<b>IA30ELN15UC</b>	<b>IA30CLN15UC</b>
NPN-NC	<b>IA30ESN15UCM1</b>	<b>IA30CSN15UCM1</b>
PNP-NC	<b>IA30ELN15UCM1</b>	<b>IA30CLN15UCM1</b>
<b>Characteristics flush and non-flush mountable</b>		
Rated operating voltage	7 - 9 VDC	7 - 9 VDC
Degree of protection	IP 67	IP 67
Housing material	Stainless steel	Thermoplastic polyester
Operating temperature	-25°C to +70°C	-25°C to +70°C
LED colour	Yellow	Yellow
Approvals/Marks	CE - UL - CSA	CE - UL - CSA

# Inductive proximity sensors, 2-wire, DC, extended range

Types	M8, Short body		M12, Short body	
Connections	2 m cable		2 m cable	M12 connector
<b>Flush mountable</b>				
	Dimensions (mm)	M8 x 30	M12 x 49	M12 x 63
	Thread (mm)	M8 x 1 x 30	M12 x 1 x 38	M12 x 1 x 38
	Operating frequency	2 kHz	1 kHz	1 kHz
	Sensing distance (Sn)	2 mm	4 mm	4 mm

<b>References</b>			
NO	<b>IA08BSF02DO</b>	<b>IA12DSF04DO</b>	<b>IA12ASF04DOM1</b>
NC	<b>IA08BSF02DC</b>	<b>IA12DSF04DC</b>	<b>IA12ASF04DCM1</b>

<b>Non-flush mountable</b>				
	Dimensions (mm)	M8 x 34	M12 x 53	M12 x 67
	Thread (mm)	M8 x 1 x 30	M12 x 1 x 38	M12 x 1 x 38
	Operating frequency	2 kHz	800 Hz	800 Hz
	Sensing distance (Sn)	4 mm	8 mm	8 mm

<b>References</b>			
NO	<b>IA08BSN04DO</b>	<b>IA12DSN08DO</b>	<b>IA12ASN08DOM1</b>
NC	<b>IA08BSN04DC</b>	<b>IA12DSN08DC</b>	<b>IA12ASN08DCM1</b>

<b>Characteristics flush and non-flush mountable</b>			
Rated operating voltage	10 - 30 VDC	10 - 40 VDC	10 - 40 VDC
Voltage drop	≤ 8 VDC @ max. load	≤ 3 VDC @ max. load	≤ 3 VDC @ max. load
Degree of protection	IP 67	IP 67	IP 67
Protection Short-circuit (S)	SPT	SPT	SPT
Reverse polarity (P)			
Transients (T)			
Output current	3 - 100 mA	5 - 100 mA	5 - 100 mA
Housing material	Nickel-plated brass	Nickel-plated brass	Nickel-plated brass
Operating temperature	-25°C to +70°C	-25°C to +70°C	-25°C to +70°C
LED colour	Yellow	Yellow	Yellow
Approvals/Marks	CE - UL - CSA	CE - UL - CSA	CE - UL - CSA

# Inductive proximity sensors, 2-wire, DC, extended range

Types	M18, Short Body		M30, Short Body	
Connections	2 m cable	M18 connector	2 m cable	M18 connector



Dimensions (mm)	M18 x 42	M18 x 55	M30 x 44	M30 x 55
Thread (mm)	M18 x 1 x 30	M18 x 1 x 30	M30 x 1.5 x 30	M30 x 1.5 x 30
Operating frequency	500 Hz	500 Hz	400 Hz	400 Hz
Sensing distance (Sn)	8 mm	8 mm	15 mm	15 mm

**References**

NO	IA18DSF08DO	IA18ASF08DOM1	IA30DSF15DO	IA30ASF15DOM1
NC	IA18DSF08DC	IA18ASF08DCM1	IA30DSF15DC	IA30ASF15DCM1



Dimensions (mm)	M18 x 50	M18 x 63	M30 x 56	M30 x 67
Thread (mm)	M18 x 1 x 30	M18 x 1 x 30	M30 x 1.5 x 30	M30 x 1.5 x 30
Operating frequency	400 Hz	400 Hz	200 Hz	200 Hz
Sensing distance (Sn)	14 mm	14 mm	22 mm	22 mm

**References**

NO	IA18DSN14DO	IA18ASN14DOM1	IA30DSN22DO	IA30ASN22DOM1
NC	IA18DSN14DC	IA18ASN14DCM1	IA30DSN22DC	IA30ASN22DCM1

## Characteristics flush and non-flush mountable

Rated operating voltage	10 - 40 VDC	10 - 40 VDC	10 - 40 VDC	10 - 40 VDC
Voltage drop	≤ 3 VDC @ max. load	≤ 3 VDC @ max. load	≤ 3 VDC @ max. load	≤ 3 VDC @ max. load
Degree of protection	IP 67	IP 67	IP 67	IP 67
Protection Short-circuit (S)				
Reverse polarity (P)	SPT	SPT	SPT	SPT
Transients (T)				
Output current	5 - 100 mA	5 - 100 mA	5 - 100 mA	5 - 100 mA
Housing material	Nickel-plated brass	Nickel-plated brass	Nickel-plated brass	Nickel-plated brass
Operating temperature	-25°C to +70°C	-25°C to +70°C	-25°C to +70°C	-25°C to +70°C
LED colour	Yellow	Yellow	Yellow	Yellow
Approvals/Marks	CE - UL - CSA	CE - UL - CSA	CE - UL - CSA	CE - UL - CSA

## Inductive proximity sensors, 3-wire, DC

Types	M5 Basic - Short body		M8 Basic - Short body	
Connections	2 m cable	M5 connector	2 m cable	M8 connector
<b>Flush mountable</b>				

Dimensions (mm)	M5 x 28	M5 x 45	M8 x 30	M8 x 45
Thread (mm)	M5 x 1 x 25	M5 x 1 x 25	M8 x 1 x 25	M8 x 1 x 25
Operating frequency	2 kHz	2 kHz	2 kHz	2 kHz
Sensing distance (Sn)	0.8 mm	0.8 mm	1.5 mm	1.5 mm

### References

NPN-NO	IA05BSF10NOP	IA05BSF10NOM5P	IA08BSF15NO	IA08BSF15NOM5
PNP-NO	IA05BSF10POP	IA05BSF10POM5P	IA08BSF15PO	IA08BSF15POM5
NPN-NC	IA05BSF10NCP	IA05BSF10NCM5P	IA08BSF15NC	IA08BSF15NCM5
PNP-NC	IA05BSF10PCP	IA05BSF10PCM5P	IA08BSF15PC	IA08BSF15PCM5

### Non-flush mountable

Dimensions (mm)		M8 x 30	M8 x 45
Thread (mm)		M8 x 1 x 27	M8 x 1 x 25
Operating frequency		2 kHz	2 kHz
Sensing distance (Sn)		2.5 mm	2.5 mm

### References

NPN-NO		IA08BSN25NO	IA08BSN25NOM5
PNP-NO		IA08BSN25PO	IA08BSN25POM5
NPN-NC		IA08BSN25NC	IA08BSN25NCM5
PNP-NC		IA08BSN25PC	IA08BSN25PCM5

### Characteristics flush and non-flush mountable

Rated operating voltage	10 - 30 VDC	10 - 30 VDC	10 - 30 VDC	10 - 30 VDC
Voltage drop	≤ 2.5 VDC	≤ 2.5 VDC	≤ 2.5 VDC	≤ 2.5 VDC
Degree of protection	IP 67	IP 67	IP 67	IP 67
Protection Short-circuit (S)				
Reverse polarity (P)	SPT	SPT	SPT	SPT
Transients (T)				
Output current	< 200 mA @ 25°C	< 200 mA @ 25°C	< 200 mA @ 25°C	< 200 mA @ 25°C
Housing material	Stainless steel	Stainless steel	Stainless steel	Stainless steel
Operating temperature	-25°C to +70°C	-25°C to +70°C	-25°C to +70°C	-25°C to +70°C
LED colour	Red	Red	Yellow	Yellow
Approvals/Marks	CE - CSA	CE - CSA	CE - UL - CSA	CE - UL - CSA



# Inductive proximity sensors, 3-wire, DC

Types	M8 Basic - Long body		
Connections	2 m cable	M8 connector	M12 connector
<b>Flush mountable</b>			

Dimensions (mm)	M8 x 45	M8 x 60	M12 x 69
Thread (mm)	M8 x 1 x 45	M8 x 1 x 40	M12 x 1 x 43
Operating frequency	2 kHz	2 kHz	2 kHz
Sensing distance (Sn)	1.5 mm	1.5 mm	1.5 mm

## References

NPN-NO	IA08BLF15NO	IA08BLF15NOM5	IA08BLF15NOM1
PNP-NO	IA08BLF15PO	IA08BLF15POM5	IA08BLF15POM1
NPN-NC	IA08BLF15NC	IA08BLF15NCM5	IA08BLF15NCM1
PNP-NC	IA08BLF15PC	IA08BLF15PCM5	IA08BLF15PCM1

<b>Non-flush mountable</b>			
----------------------------	--	--	---

Dimensions (mm)	M8 x 45	M8 x 60	M12 x 69
Thread (mm)	M8 x 1 x 42	M12 x 1 x 37	M8 x 1 x 40
Operating frequency	2 kHz	800 Hz	800 Hz
Sensing distance (Sn)	4 mm	8 mm	8 mm









## References

NPN-NO	IA08BLN25NO	IA08BLN25NOM5	IA08BLN25NOM1
PNP-NO	IA08BLN25PO	IA08BLN25POM5	IA08BLN25POM1
NPN-NC	IA08BLN25NC	IA08BLN25NCM5	IA08BLN25NCM1
PNP-NC	IA08BLN25PC	IA08BLN25PCM5	IA08BLN25PCM1



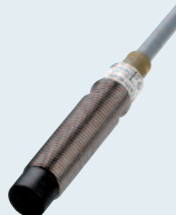



## Characteristics flush and non-flush mountable

Rated operating voltage	10 - 30 VDC	10 - 30 VDC	10 - 30 VDC
Voltage drop	≤ 2.5 VDC	≤ 2.5 VDC	≤ 2.5 VDC
Degree of protection	IP 67	IP 67	IP 67
Protection Short-circuit (S)			
Reverse polarity (P)	SPT	SPT	SPT
Transients (T)			
Output current	< 200 mA @ 25°C	< 200 mA @ 25°C	< 200 mA @ 25°C
Housing material	Stainless steel	Stainless steel	Stainless steel
Operating temperature	-25°C to +70°C	-25°C to +70°C	-25°C to +70°C
LED colour	Yellow	Yellow	Yellow
Approvals/Marks	CE - UL - CSA	CE - UL - CSA	CE - UL - CSA





# Inductive proximity sensors, 3-wire, DC

Types	M12 standard - Short body		M12 standard - Long body	
Connections	2 m cable	M12 connector	2 m cable	M12 connector
<b>Flush mountable</b>				
Dimensions (mm)	M12 x 50	M12 x 51	M12 x 65	M12 x 66
Thread (mm)	M12 x 1 x 32	M12 x 1 x 29	M12 x 1 x 47	M12 x 1 x 44
Operating frequency	1.5 kHz	1.5 kHz	1.5 kHz	1.5 kHz
Sensing distance (Sn)	2 mm	2 mm	2 mm	2 mm
<b>References</b>				
NPN-NO	ICB12SF02NO	ICB12SF02NOM1	ICB12LF02NO	ICB12LF02NOM1
PNP-NO	ICB12SF02PO	ICB12SF02POM1	ICB12LF02PO	ICB12LF02POM1
NPN-NC	ICB12SF02NC	ICB12SF02NCM1	ICB12LF02NC	ICB12LF02NCM1
PNP-NC	ICB12SF02PC	ICB12SF02PCM1	ICB12LF02PC	ICB12LF02PCM1
<b>Non-flush mountable</b>				
Dimensions (mm)	M12 x 50	M12 x 51	M12 x 65	M12 x 66
Thread (mm)	M12 x 1 x 25	M12 x 1 x 29	M12 x 1 x 40	M12 x 1 x 38
Operating frequency	1.5 kHz	1.5 kHz	1.5 kHz	1.5 kHz
Sensing distance (Sn)	4 mm	4 mm	4 mm	4 mm
<b>References</b>				
NPN-NO	ICB12SN04NO	ICB12SN04NOM1	ICB12LN04NO	ICB12LN04NOM1
PNP-NO	ICB12SN04PO	ICB12SN04POM1	ICB12LN04PO	ICB12LN04POM1
NPN-NC	ICB12SN04NC	ICB12SN04NCM1	ICB12LN04NC	ICB12LN04NCM1
PNP-NC	ICB12SN04PC	ICB12SN04PCM1	ICB12LN04PC	ICB12LN04PCM1
<b>Characteristics flush and non-flush mountable</b>				
Rated operating voltage	10 - 36 VDC	10 - 36 VDC	10 - 36 VDC	10 - 36 VDC
Voltage drop	≤ 2.5 VDC @ 200mA	≤ 2.5 VDC @ 200mA	≤ 2.5 VDC @ 200mA	≤ 2.5 VDC @ 200mA
Degree of protection	IP 67	IP 67	IP 67	IP 67
Protection Short-circuit (S) Reverse polarity (P) Transients (T)	SPT	SPT	SPT	SPT
Output current	< 200 mA @ 25°C ≤ 150 mA @ 50-70°C	< 200 mA @ 25°C ≤ 150 mA @ 50-70°C	< 200 mA @ 25°C ≤ 150 mA @ 50-70°C	< 200 mA @ 25°C ≤ 150 mA @ 50-70°C
Housing material	Nickel-plated brass	Nickel-plated brass	Nickel-plated brass	Nickel-plated brass
Operating temperature	-25°C to +70°C	-25°C to +70°C	-25°C to +70°C	-25°C to +70°C
LED colour	Yellow	Yellow	Yellow	Yellow
Approvals/Marks	CE - UL	CE - UL	CE - UL	CE - UL

# Inductive proximity sensors, 3-wire, DC





Types	M18 basic - Short body		M18 basic - Long body	
Connections	2 m cable	M12 connector	2 m cable	M12 connector
<b>Flush mountable</b>				
Dimensions (mm)	M18 x 41.6	M18 x 55	M18 x 61.6	M18 x 75
Thread (mm)	M18 x 1 x 30	M18 x 1 x 30	M18 x 1 x 50	M18 x 1 x 50
Operating frequency	1.5 kHz	1.5 kHz	1.5 kHz	1.5 kHz
Sensing distance (Sn)	5 mm	5 mm	5 mm	5 mm
<b>References</b>				
NPN-NO	<b>IA18DSF05NO</b>	<b>IA18ASF05NOM1</b>		
PNP-NO	<b>IA18DSF05PO</b>	<b>IA18ASF05POM1</b>	<b>IA18DLF05PO</b>	<b>IA18ALF05POM1</b>
NPN-NC	<b>IA18DSF05NC</b>	<b>IA18ASF05NCM1</b>		
PNP-NC	<b>IA18DSF05PC</b>	<b>IA18ASF05PCM1</b>	<b>IA18DLF05PC</b>	<b>IA18ALF05PCM1</b>
<b>Non-flush mountable</b>				
Dimensions (mm)	M18 x 49.6	M18 x 63		
Thread (mm)	M18 x 1 x 30	M18 x 1 x 30		
Operating frequency	1.5 kHz	1.5 kHz		
Sensing distance (Sn)	5 mm	5 mm		
<b>References</b>				
NPN-NO	<b>IA18DSN08NO</b>	<b>IA18ASN08NOM1</b>		
PNP-NO	<b>IA18DSN08PO</b>	<b>IA18ASN08POM1</b>		
NPN-NC	<b>IA18DSN08NC</b>	<b>IA18ASN08NCM1</b>		
PNP-NC	<b>IA18DSN08PC</b>	<b>IA18ASN08PCM1</b>		
<b>Characteristics flush and non-flush mountable</b>				
Rated operating voltage	10 - 40 VDC	10 - 40 VDC	10 - 40 VDC	10 - 40 VDC
Voltage drop	≤ 2.5 VDC	≤ 2.5 VDC	≤ 2.5 VDC	≤ 2.5 VDC
Degree of protection	IP 67	IP 67	IP 67	IP 67
Protection Short-circuit (S)				
Reverse polarity (P)	SPT	SPT	SPT	SPT
Transients (T)				
Output current	< 200 mA @ 25°C	< 200 mA @ 25°C	< 200 mA @ 25°C	< 200 mA @ 25°C
Housing material	Nickel-plated brass + plastic	Nickel-plated brass	Nickel-plated brass + plastic	Nickel-plated brass
Operating temperature	-25°C to +70°C	-25°C to +70°C	-25°C to +70°C	-25°C to +70°C
LED colour	Yellow	Yellow	Yellow	Yellow
Approvals/Marks	CE - UL - CSA	CE - UL - CSA	CE - UL - CSA	CE - UL - CSA

# Inductive proximity sensors, 3-wire, DC

Types	M30 basic - Short body		M30 basic - Long body	
Connections	2 m cable	M12 connector	2 m cable	M12 connector
<b>Flush mountable</b>				
Dimensions (mm)	M30 x 43.6	M30 x 55	M30 x 63.6	M30 x 75
Thread (mm)	M30 x 1.5 x 30	M30 x 1.5 x 30	M30 x 1.5 x 50	M30 x 1.5 x 50
Operating frequency	700 Hz	700 Hz	700 Hz	700 Hz
Sensing distance (Sn)	10 mm	10 mm	10 mm	10 mm
<b>References</b>				
NPN-NO	<b>IA30DSF10NO</b>	<b>IA30ASF10NOM1</b>		
PNP-NO	<b>IA30DSF10PO</b>	<b>IA30ASF10POM1</b>	<b>IA30DLF10PO</b>	<b>IA30ALF10POM1</b>
NPN-NC				
PNP-NC			<b>IA30DLF10PC</b>	
<b>Non-flush mountable</b>				
Dimensions (mm)	M30 x 55.6	M30 x 66		
Thread (mm)	M30 x 1.5 x 30	M30 x 1.5 x 30		
Operating frequency	700 Hz	700 Hz		
Sensing distance (Sn)	15 mm	15 mm		
<b>References</b>				
NPN-NO	<b>IA30DSN15NO</b>	<b>IA30ASN15NOM1</b>		
PNP-NO	<b>IA30DSN15PO</b>	<b>IA30ASN15POM1</b>		
NPN-NC				
PNP-NC				
<b>Characteristics flush and non-flush mountable</b>				
Rated operating voltage	10 - 40 VDC	10 - 40 VDC	10 - 40 VDC	10 - 40 VDC
Voltage drop	≤ 2.5 VDC	≤ 2.5 VDC	≤ 2.5 VDC	≤ 2.5 VDC
Degree of protection	IP 67	IP 67	IP 67	IP 67
Protection Short-circuit (S)				
Reverse polarity (P)	SPT	SPT	SPT	SPT
Transients (T)				
Output current	< 200 mA @ 25°C	< 200 mA @ 25°C	< 200 mA @ 25°C	< 200 mA @ 25°C
Housing material	Nickel-plated brass + plastic	Nickel-plated brass	Nickel-plated brass + plastic	Nickel-plated brass
Operating temperature	-25°C to +70°C	-25°C to +70°C	-25°C to +70°C	-25°C to +70°C
LED colour	Yellow	Yellow	Yellow	Yellow
Approvals/Marks	CE - UL - CSA	CE - UL - CSA	CE - UL - CSA	CE - UL - CSA



# Inductive proximity sensors, 3-wire, DC, extended range

Types	M8 basic - Extended	
Connections	2 m cable	M8 connector
<b>Flush mountable</b>		
Dimensions (mm)	M8 x 35 x 30	M8 x 45
Thread (mm)	M8 x 1 x 35	M8 x 1 x 30
Operating frequency	2 kHz	2 kHz
Sensing distance (Sn)	2 mm	2 mm
<b>References</b>		
NPN-NO	IA08BSF20NO	IA08BSF20NOM5
PNP-NO	IA08BSF20PO	IA08BSF20POM5
NPN-NC	IA08BSF20NC	IA08BSF20NCM5
PNP-NC	IA08BSF20PC	IA08BSF20PCM5
<b>Non-flush mountable</b>		
Dimensions (mm)	M8 x 30	M8 x 45
Thread (mm)	M8 x 1 x 27	M8 x 1 x 22
Operating frequency	1 kHz	1 kHz
Sensing distance (Sn)	4 mm	4 mm
<b>References</b>		
NPN-NO	IA08BSN40NO	IA08BSN40NOM5
PNP-NO	IA08BSN40PO	IA08BSN40POM5
NPN-NC	IA08BSN40NC	IA08BSN40NCM5
PNP-NC	IA08BSN40PC	IA08BSN40PCM5
<b>Characteristics flush and non-flush mountable</b>		
Rated operating voltage	10 - 40 VDC	10 - 40 VDC
Voltage drop	≤ 2.5 VDC	≤ 2.5 VDC
Degree of protection	IP 67	IP 67
Protection Short-circuit (S)	SPT	SPT
Reverse polarity (P)		
Transients (T)		
Output current	< 200 mA @ 25°C	< 200 mA @ 25°C
Housing material	Stainless steel	Stainless steel
Operating temperature	-25°C to +70°C	-25°C to +70°C
LED colour	Yellow	Yellow
Approvals/Marks	CE - UL - CSA	CE - UL - CSA

References: x= S (Short) or L (Long)

# Inductive proximity sensors, 3-wire, DC, extended range

## Types

### M12 Extended

Connections	2 m cable	M12 connector	2 m cable	M12 connector
-------------	-----------	---------------	-----------	---------------

### Flush mountable



Dimensions (mm)	M12 x 50	M12 x 51	M12 x 65	M12 x 66
Thread (mm)	M12 x 1 x 32	M12 x 1 x 29	M12 x 1 x 47	M12 x 1 x 44
Operating frequency	1.5 kHz	1.5 kHz	1.5 kHz	1.5 kHz
Sensing distance (Sn)	4 mm	4 mm	4 mm	4 mm

### References

NPN-NO	<b>ICB12SF04NO</b>	<b>ICB12SF04NOM1</b>	<b>ICB12LF04NO</b>	<b>ICB12LF04NOM1</b>
PNP-NO	<b>ICB12SF04PO</b>	<b>ICB12SF04POM1</b>	<b>ICB12LF04PO</b>	<b>ICB12LF04POM1</b>
NPN-NC	<b>ICB12SF04NC</b>	<b>ICB12SF04NCM1</b>	<b>ICB12LF04NC</b>	<b>ICB12LF04NCM1</b>
PNP-NC	<b>ICB12SF04PC</b>	<b>ICB12SF04PCM1</b>	<b>ICB12LF04PC</b>	<b>ICB12LF04PCM1</b>

### Non-flush mountable



Dimensions (mm)	M12 x 50	M12 x 51	M12 x 65	M12 x 66
Thread (mm)	M12 x 1 x 25	M12 x 1 x 29	M12 x 1 x 40	M12 x 1 x 38
Operating frequency	1.5 kHz	1.5 kHz	1.5 kHz	1.5 kHz
Sensing distance (Sn)	8 mm	8 mm	8 mm	8 mm







### References

NPN-NO	<b>ICB12SN08NO</b>	<b>ICB12SN08NOM1</b>	<b>ICB12LN08NO</b>	<b>ICB12LN08NOM1</b>
PNP-NO	<b>ICB12SN08PO</b>	<b>ICB12SN08POM1</b>	<b>ICB12LN08PO</b>	<b>ICB12LN08POM1</b>
NPN-NC	<b>ICB12SN08NC</b>	<b>ICB12SN08NCM1</b>	<b>ICB12LN08NC</b>	<b>ICB12LN08NCM1</b>
PNP-NC	<b>ICB12SN08PC</b>	<b>ICB12SN08PCM1</b>	<b>ICB12LN08PC</b>	<b>ICB12LN08PCM1</b>

### Characteristics flush and non-flush mountable

Rated operating voltage	10 - 36 VDC	10 - 36 VDC	10 - 36 VDC	10 - 36 VDC
Voltage drop	≤ 2.5 VDC @ 200 mA	≤ 2.5 VDC @ 200 mA	≤ 2.5 VDC @ 200 mA	≤ 2.5 VDC @ 200 mA
Degree of protection	IP 67	IP 67	IP 67	IP 67
Protection Short-circuit (S)	SPT	SPT	SPT	SPT
Reverse polarity (P)	SPT	SPT	SPT	SPT
Transients (T)	SPT	SPT	SPT	SPT
Output current	≤ 200 mA @ 50°C ≤ 150 mA @ 50-70°C	≤ 200 mA @ 50°C ≤ 150 mA @ 50-70°C	≤ 200 mA @ 50°C ≤ 150 mA @ 50-70°C	≤ 200 mA @ 50°C ≤ 150 mA @ 50-70°C
Housing material	Nickel-plated brass	Nickel-plated brass	Nickel-plated brass	Nickel-plated brass
Operating temperature	-25°C to +70°C	-25°C to +70°C	-25°C to +70°C	-25°C to +70°C
LED colour	Yellow	Yellow	Yellow	Yellow
Approvals/Marks	CE - UL	CE - UL	CE - UL	CE - UL

# Inductive proximity sensors, 3-wire, DC, extended range

Types	M18 basic - Extended		M30 basic - Extended	
Connections	2 m cable	M12 connector	2 m cable	M12 connector
<b>Flush mountable</b>				
Dimensions (mm)	M18 x 41.6	M18 x 55	M30 x 43.6	M30 x 55
Thread (mm)	M18 x 1 x 30	M18 x 1 x 30	M30 x 1.5 x 30	M30 x 1.5 x 50
Operating frequency	500 Hz	500 Hz	700 Hz	700 Hz
Sensing distance (Sn)	8 mm	8 mm	15 mm	15 mm
<b>References</b>				
NPN-NO	<b>IA18DSF08NO</b>	<b>IA18ASF08NOM1</b>	<b>IA30DSF15NO</b>	<b>IA30ASF15NOM1</b>
PNP-NO	<b>IA18DSF08PO</b>	<b>IA18ASF08POM1</b>	<b>IA30DSF15PO</b>	<b>IA30ASF15POM1</b>
NPN-NC				
PNP-NC			<b>IA30DSF15PC</b>	
<b>Non-flush mountable</b>				
Dimensions (mm)	M18 x 49.6	M18 x 63	M30 x 55.6	M30 x 67
Thread (mm)	M18 x 1 x 30	M18 x 1 x 30	M30 x 1.5 x 30	M30 x 1.5 x 30
Operating frequency	400 Hz	400 Hz	500 Hz	500 Hz
Sensing distance (Sn)	14 mm	14 mm	22 mm	22 mm
<b>References</b>				
NPN-NO	<b>IA18DSN14NO</b>	<b>IA18ASN14NOM1</b>	<b>IA30DSN22NO</b>	<b>IA30ASN22NOM1</b>
PNP-NO	<b>IA18DSN14PO</b>	<b>IA18ASN14POM1</b>	<b>IA30DSN22PO</b>	<b>IA30ASN22POM1</b>
<b>Characteristics flush and non-flush mountable</b>				
Rated operating voltage	10 - 40 VDC	10 - 40 VDC	10 - 40 VDC	10 - 40 VDC
Voltage drop	≤ 2.5 VDC	≤ 2.5 VDC	≤ 2.5 VDC	≤ 2.5 VDC
Degree of protection	IP 67	IP 67	IP 67	IP 67
Protection Short-circuit (S)				
Reverse polarity (P)	SPT	SPT	SPT	SPT
Transients (T)				
Output current	< 200 mA @ 25°C	< 200 mA @ 25°C	< 200 mA @ 25°C	< 200 mA @ 25°C
Housing material	Stainless steel	Stainless steel	Nickel-plated brass + plastic	Nickel-plated brass
Operating temperature	-25°C to +70°C	-25°C to +70°C	-25°C to +70°C	-25°C to +70°C
LED colour	Yellow	Yellow	Yellow	Yellow
Approvals/Marks	CE - UL - CSA	CE - UL - CSA	CE - UL - CSA	CE - UL - CSA

# Inductive proximity sensors, 2-wire, AC

## Types

### M12 basic - Long body

#### Connections

#### 2 m cable

#### M12 connector

#### Flush mountable



Dimensions (mm)	M12 x 66	M12 x 74.5
Thread (mm)	M12 x 1 x 50	M12 x 1 x 50
Operating frequency	25 Hz	25 Hz
Sensing distance (Sn)	2 mm	2 mm

#### References

SCR-NO	EI1202TBOSL	EI1202TBOSL-6
SCR-NC	EI1202TBCSL	

#### Non-flush mountable



Dimensions (mm)	M12 x 74	M12 x 82.5
Thread (mm)	M12 x 1 x 50	M12 x 1 x 50
Operating frequency	25 Hz	25 Hz
Sensing distance (Sn)	4 mm	4 mm

#### References

SCR-NO	EI1204TBOSL	EI1204TBOSL-6
SCR-NC	EI1204TBCSL	

#### Characteristics flush and non-flush mountable

Rated operating voltage	20 - 265 VDC	20 - 265 VDC
Voltage drop	≤ 8 VDC	≤ 8 VDC
Degree of protection	IP 67	IP 67
Protection Short-circuit (S)		
Reverse polarity (P)	T	T
Transients (T)		
Output current	< 500 mA	< 500 mA
Housing material	Stainless steel	Stainless steel
Operating temperature	-25°C to +70°C	-25°C to +70°C
LED colour	Yellow	Yellow
Approvals/Marks	CE - UL - CSA	CE - UL - CSA

# Inductive proximity sensors, 2-wire, AC

Types	M18 basic - Short body		M18 basic - Long body	
Connections	2 m cable	M12 connector	2 m cable	M12 connector



Dimensions (mm)	M18 x 57	M18 x 55	M18 x 77	M18 x 75
Thread (mm)	M18 x 1 x 30	M18 x 1 x 30	M18 x 1 x 50	M18 x 1 x 50
Operating frequency	25 kHz	25 kHz	25 kHz	25 kHz
Sensing distance (Sn)	5 mm	5 mm	5 mm	5 mm

**References**

SCR-NO	<b>EI1805TBOSS</b>	<b>EI1805TBOSS-6</b>	<b>EI1805TBOSL</b>	<b>EI1805TBOSL-6</b>
SCR-NC	<b>EI1805TBCSS</b>		<b>EI1805TBCSL</b>	



Dimensions (mm)	M18 x 73	M18 x 71	M18 x 93	M18 x 93
Thread (mm)	M18 x 1 x 30	M18 x 1 x 30	M18 x 1 x 50	M18 x 1 x 50
Operating frequency	25 kHz	25 kHz	25 kHz	25 kHz
Sensing distance (Sn)	8 mm	8 mm	8 mm	8 mm

**References**

SCR-NO	<b>EI1808TBOSS</b>	<b>EI1808TBOSS-6</b>	<b>EI1808TBOSL</b>	<b>EI1808TBOSL-6</b>
SCR-NC	<b>EI1808TBCSS</b>		<b>EI1808TBCSL</b>	<b>EI1808TBCSL-6</b>

**Characteristics flush and non-flush mountable**

Rated operating voltage	20 - 265 VAC	20 - 265 VAC	20 - 265 VAC	20 - 265 VAC
Voltage drop	≤ 8 VDC	≤ 8 VDC	≤ 8 VDC	≤ 8 VDC
Degree of protection	IP 67	IP 67	IP 67	IP 67
Protection Short-circuit (S)				
Reverse polarity (P)	T	T	T	T
Transients (T)				
Output current	< 500 mA	< 500 mA	< 500 mA	< 500 mA
Housing material	Stainless Steel	Stainless Steel	Stainless Steel	Stainless Steel
Operating temperature	-25°C to +70°C	-25°C to +70°C	-25°C to +70°C	-25°C to +70°C
LED colour	Yellow	Yellow	Yellow	Yellow
Approvals/Marks	CE - UL - CSA	CE - UL - CSA	CE - UL - CSA	CE - UL - CSA

# Inductive proximity sensors, 2-wire, AC

Types	M30 Basic - Short Body		M30 Basic - Long Body	
Connections	2 m cable	M12 connector	2 m cable	M12 connector

## Flush mountable



Dimensions (mm)	M30 x 59		M30 x 79	M30 x 75.5
Thread (mm)	M30 x 1.5 x 30		M30 x 1.5 x 30	M30 x 1.5 x 30
Operating frequency	25 kHz		25 kHz	25 kHz
Sensing distance (Sn)	10 mm		10 mm	10 mm

## References

SCR-NO	EI3010TBOSS		EI3010TBOSL	EI3010TBOSL-6
SCR-NC	EI3010TBCSS		EI3010TBCSL	

## Non-flush mountable



Dimensions (mm)	M30 x 99.5	M30 x 79.5	M30 x 103	M30 x 83
Thread (mm)	M30 x 1.5 x 30	M30 x 1.5 x 30	M30 x 1.5 x 30	M30 x 1.5 x 30
Operating frequency	25 kHz	25 kHz	25 kHz	25 kHz
Sensing distance (Sn)	15 mm	15 mm	15 mm	15 mm







## References

SCR-NO	EI3015TBOSS	EI3015TBOSS-6	EI3015TBOSL	EI3015TBOSL-6
SCR-NC	EI3015TBCSS		EI3015TBCSL	





## Characteristics flush and non-flush mountable

Rated operating voltage	20 - 265 VAC	20 - 265 VAC	20 - 265 VAC	20 - 265 VAC
Voltage drop	≤ 8 VDC	≤ 8 VDC	≤ 8 VDC	≤ 8 VDC
Degree of protection	IP 67	IP 67	IP 67	IP 67
Protection Short-circuit (S)				
Reverse polarity (P)	T	T	T	T
Transients (T)				
Output current	< 500 mA	< 500 mA	< 500 mA	< 500 mA
Housing material	Stainless Steel	Stainless Steel	Stainless Steel	Stainless Steel
Operating temperature	-25°C to +70°C	-25°C to +70°C	-25°C to +70°C	-25°C to +70°C
LED colour	Yellow	Yellow	Yellow	Yellow
Approvals/Marks	CE - UL - CSA	CE - UL - CSA	CE - UL - CSA	CE - UL - CSA

# Inductive Proximity Sensors, 2-Wire, AC

Types	M18 - Short body		M18 - Long body		M30 - Long body	
Connections	2 m cable		2 m cable	M12 connector	2 m cable	
<b>Flush mountable</b>						
Dimensions (mm)	M18 x 41.6		M18 x 55		M30 x 79	
Thread (mm)	M18 x 1 x 30		M18 x 1 x 30		M30 x 1.5 x 50	
Operating frequency	500 Hz		500 Hz		25 Hz	
Sensing distance (Sn)	8 mm		8 mm		10 mm	
<b>References</b>						
SCR-NO	E11805TBOPS		E11805TBOPL		E13010TBOPL	
<b>Non-flush mountable</b>						
Dimensions (mm)			M18 x 93		M18 x 91	M30 x 103
Thread (mm)			M18 x 1 x 50		M18 x 1 x 50	M30 x 1.5 x 50
Operating frequency			25 kHz		25 kHz	25 kHz
Sensing distance (Sn)			8 mm		8 mm	15 mm
<b>References</b>						
SCR-NO			E11808TBOPL		E13015TBOPL	
SCR-NC			E11808TBCPL		E11808TBCPL-6	
<b>Characteristics flush and non-flush mountable</b>						
Rated operating voltage	20 - 265 VAC		20 - 265 VAC		20 - 265 VAC	20 - 265 VAC
Voltage drop	≤ 8 VDC		≤ 8 VDC		≤ 8 VDC	≤ 8 VDC
Degree of protection	IP 67		IP 67		IP 67	IP 67
Protection Short-circuit (S)						
Reverse polarity (P)	T		T		T	T
Transients (T)						
Output current	< 500 mA		< 500 mA		< 500 mA	< 500 mA
Housing material	Thermoplastic polyester		Thermoplastic polyester		Thermoplastic polyester	Thermoplastic polyester
Operating temperature	-25°C to +70°C		-25°C to +70°C		-25°C to +70°C	-25°C to +70°C
LED colour	Yellow		Yellow		Yellow	Yellow
Approvals/Marks	CE - UL - CSA		CE - UL - CSA		CE - UL - CSA	CE - UL - CSA

# Inductive proximity sensors, high temperature





Types	M5	M8	M12		
Connections	2 m cable	2 m cable	2 m cable or M12 connector		
Flush or non-flush mountable					
	Dimensions (mm)	M5 x 30	M8 x 45	M12 x 40	M12 x 40
	Thread (mm)	M5 x 0.5 x 25	M5 x 1 x 40	M12 x 1 x 40	M12 x 1 x 34
	Sensing distance (Sn)	0.8 mm	1 mm	2 mm	4 mm
Output	≤ 5 mA	≤ 5 mA	≤ 20 mA	≤ 20 mA	

## References

NPN-NO Cable	IA05BSF08NOHT-K	IA08BSF10NOHT-K	IA12ASN04NOHT-K	
PNP-NO Cable	IA05BSF08POHT-K	IA08BSF10POHT-K	IA12ASF02POHT-K	IA12ASN04POHT-K
PNP-NO Plug			IA12ASF02POM1HT-K	IA12ASN04POM1HT-K

## Specifications

Rated operating voltage	15 - 30 VDC	15 - 30 VDC	10 - 30 VDC	10 - 30 VDC
Degree of protection	IP 67	IP 67	IP 67	IP 67
Protection	Short-circuit	Short-circuit	Short-circuit	Short-circuit
Housing material	Stainless steel	Stainless steel	Nickel-plated brass	Nickel-plated brass
Operating temperature	-25°C to +120°C	-25°C to +120°C	-40°C to +100°C	-40°C to +100°C
Approvals/Marks	CE	CE	CE	CE

Types	M18		M30		
Connections	2 m cable or M12 connector		2 m cable or M12 connector		
Flush or non-flush mountable					
	Dimensions (mm)	M18 x 40	M18 x 40	M30 x 40	M30 x 40
	Thread (mm)	M18 x 1 x 40	M18 x 1 x 32	M30 x 1.5 x 40	M30 x 1.5 x 28
	Sensing distance (Sn)	5 mm	8 mm	10 mm	15 mm
Output	≤ 25 mA	≤ 25 mA	≤ 25 mA	≤ 25 mA	

## References

PNP-NO Cable	IA18ASF05POHT-K	IA18ASN08POHT-K	IA30ASF10POHT-K	IA30ASN15POHT-K
PNP-NO Plug	IA18ASF05POM1HT-K	IA18ASN08POM1HT-K	IA30ASF10POM1HT-K	IA30ASN15POM1HT-K

## Characteristics flush and non-flush mountable

Rated operating voltage	10 - 30 VDC	10 - 30 VDC	10 - 30 VDC	10 - 30 VDC
Degree of protection	IP 67	IP 67	IP 67	IP 67
Protection	Short-circuit	Short-circuit	Short-circuit	Short-circuit
Housing material	Nickel-plated brass	Nickel-plated brass	Nickel-plated brass	Nickel-plated brass
Operating temperature	-40°C to +100°C	-40°C to +100°C	-40°C to +100°C	-40°C to +100°C
Approvals/Marks	CE	CE	CE	CE



# Inductive proximity sensors, micro switch 2-wire AC

<b>Types</b>	<b>Micro switch</b>
--------------	---------------------

<b>Connections</b>	<b>2 m cable</b>
--------------------	------------------



Dimensions body (mm)	30 x 19 x 15
Thread tip (mm)	Ø 12 x 16
Operating frequency	1 kHz
Sensing distance (Sn)	4 mm



## References

NO	<b>IG12FSF04DO</b>
NC	<b>IG12FSF04DC</b>

## Specifications

Rated operating voltage	10 to 40 VDC
Voltage drop	≤ 3 VDC at max. load
Degree of protection	IP67
Protection Short-circuit (S) Reverse polarity (P) Transients (T)	SPT
Output current	≤ 5 - 100 mA
Housing material	Anodized Aluminium
Operating temperature	-25°C to +70°C
Approvals/Marks	CE

# Inductive proximity sensors, switch, polyester housing

Types	Transistor NPN/PNP		Power MOSFET output AC types	
Connections	Terminals		Terminals	Terminals
<b>Non-flush mountable</b>				
	Dimensions (mm)	40 x 40 x 118	40 x 40 x 118	40 x 40 x 118
	Operating frequency	≤ 100 Hz	≤ 25 Hz AC; 40 Hz DC	≤ 25 Hz
	Sensing distance (Sn)	30 mm	30 mm	30 mm
<b>References</b>				
NPN - NO/NC	<b>IC40CNN30NAT1</b>			
PNP - NO/NC	<b>IC40CNN30PAT1</b>			
AC/DC - NO			<b>IC40CNN30COT1</b>	
AC/DC - NC			<b>IC40CNN30CCT1</b>	
AC - NO/NC				<b>IC40CNN30TAT1</b>
<b>Specifications</b>				
Rated operating voltage	10 - 30 VDC	20 - 250 VAC/DC	20 - 250 VAC	
Degree of protection	IP 67	IP 67	IP 67	
Protection Short-circuit (S) Reverse polarity (P) Transients (T)	SP	SP	SP	
Output current	≤ 200 mA	5 - 200 mA	5 - 200 mA	
Housing material	Thermoplastic polyester	Thermoplastic polyester	Thermoplastic polyester	
Operating temperature	-25°C to +70°C	-25°C to +70°C	-25°C to +70°C	
LED colour	Yellow, green	Yellow, green	Yellow, green	
Approvals/Marks	CE	CE	CE	

# Inductive proximity sensors, loop detector

Types	Single loop	Dual loop
Connections	Plug 11 pin circular	Plug 11 pin circular











Adjustment	Auto	Auto
Manual fine-tune	Yes	Yes
Loop inductance	15-1500 mH	15-1500 mH
Input	1 Loop	2 Loop
Output	2 x SPDT, 1A / 250 VAC	2 x SPDT, 1A / 250 VAC

References		
24 VAC/DC	<b>LDP1SA1BM24</b>	<b>LDP2TA2BM24</b>
115 VAC	<b>LDP1SA1B115</b>	<b>LDP2TA2B115</b>
230 VAC	<b>LDP1SA1B230</b>	<b>LDP2TA2B230</b>









Specifications		
Operating temperature	-40°C to +70°C	-40°C to +70°C
Mounting	11 pin circular plug	11 pin circular plug
Approvals/Marks	CE - UL - CSA	CE - UL - CSA

# Capacitive proximity sensors, TRIPLESIELD™

Types	M18-DC TRIPLESIELD™		M18-AC TRIPLESIELD™	
Connections	2 m cable	M12 connector	2 m cable	M12 connector
<b>Flush mountable</b>				
Dimensions (mm)	M18 x 71.5	M18 x 83.5	M18 x 71.5	M18 x 83.5
Thread (mm)	M18 x 1 x 46.5	M18 x 1 x 46.5	M18 x 1 x 46.5	M18 x 1 x 46.5
Operating frequency	30 Hz	30 Hz	10 Hz	10 Hz
Sensing distance (Sn)	3 - 8 mm (adjustable)	3 - 8 mm (adjustable)	3 - 8 mm (adjustable)	3 - 8 mm (adjustable)
<b>References</b>				
NPN - NO and NC	<b>CA18CLF08NA</b>	<b>CA18CLF08NAM1</b>		
PNP - NO and NC	<b>CA18CLF08PA</b>	<b>CA18CLF08PAM1</b>		
Thyristor (SCR) NO			<b>CA18CLF08TO</b>	<b>CA18CLF08TOM6</b>
Thyristor (SCR) NC			<b>CA18CLF08TC</b>	<b>CA18CLF08TCM6</b>
<b>Non-flush mountable</b>				
Dimensions (mm)	M18 x 79.5	M18 x 91.5	M18 x 79.5	M18 x 91.5
Thread (mm)	M18 x 1 x 46.5	M18 x 1 x 46.5	M18 x 1 x 46.5	M18 x 1 x 46.5
Operating frequency	30 Hz	30 Hz	10 Hz	10 Hz
Sensing distance (Sn)	3 - 12 mm (adjustable)	3 - 12 mm (adjustable)	3 - 12 mm (adjustable)	3 - 12 mm (adjustable)
<b>References</b>				
NPN - NO and NC	<b>CA18CLN12NA</b>	<b>CA18CLN12NAM1</b>		
PNP - NO and NC	<b>CA18CLN12PA</b>	<b>CA18CLN12PAM1</b>		
Thyristor (SCR) NO			<b>CA18CLN12TO</b>	<b>CA18CLN12TOM6</b>
Thyristor (SCR) NC			<b>CA18CLN12TC</b>	<b>CA18CLN12TCM6</b>
<b>Characteristics flush and non-flush mountable</b>				
Rated operating voltage	10 - 40 VDC	10 - 40 VDC	20 - 250 VAC	20 - 250 VAC
Voltage drop	≤ 2.5 VDC	≤ 2.5 VDC	≤ 10 VAC	≤ 10 VAC
Degree of protection	IP 67	IP 67	IP 67	IP 67
Protection Short-circuit (S)				
Reverse polarity (P)	SPT	SPT	T	T
Transients (T)				
Output current	< 200 mA	< 200 mA	< 500 mA	< 500 mA
Housing material	Thermoplastic polyester	Thermoplastic polyester	Thermoplastic polyester	Thermoplastic polyester
Operating temperature	-25°C to +80°C	-25°C to +80°C	-25°C to +80°C	-25°C to +80°C
LED colour	Yellow	Yellow	Yellow	Yellow
Approvals/Marks	CE - UL - CSA	CE - UL - CSA	CE - UL - CSA	CE - UL - CSA

Also available in Teflon, polypropylene and PVC housing.  
Please see page 33

# Capacitive proximity sensors, TRIPLESIELD™

Types	M30-DC TRIPLESIELD™			
Connections	2 m cable	M12 connector	2 m cable	M12 connector
<b>Flush mountable</b>				
Dimensions (mm)	M30 x 63.6	M30 x 63.6	M30 x 63.6	M30 x 63.6
Thread (mm)	M30 x 1.5 x 50	M30 x 1.5 x 50	M30 x 1.5 x 50	M30 x 1.5 x 50
Operating frequency	50 Hz	50 Hz	50 Hz	50 Hz
Sensing distance (Sn)	2 - 16 mm (adjustable)	2 - 16 mm (adjustable)	2 - 16 mm (adjustable)	2 - 16 mm (adjustable)
<b>References</b>				
NPN - NO and NC	<b>EC3016NPASL</b>	<b>EC3016NPASL-1</b>	<b>EC3016NPAPL</b>	<b>EC3016NPAPL-1</b>
PNP - NO and NC	<b>EC3016PPASL</b>	<b>EC3016PPASL-1</b>	<b>EC3016PPAPL</b>	<b>EC3016PPAPL-1</b>
<b>Non-flush mountable</b>				
Dimensions (mm)	M30 x 75.6	M30 x 75.6	M30 x 75.6	M30 x 75.6
Thread (mm)	M30 x 1.5 x 50	M30 x 1.5 x 50	M30 x 1.5 x 50	M30 x 1.5 x 50
Operating frequency	50 Hz	50 Hz	50 Hz	50 Hz
Sensing distance (Sn)	4 - 25 mm (adjustable)	4 - 25 mm (adjustable)	4 - 25 mm (adjustable)	4 - 25 mm (adjustable)
<b>References</b>				
NPN - NO and NC	<b>EC3025NPASL</b>	<b>EC3025NPASL-1</b>	<b>EC3025NPAPL</b>	<b>EC3025NPAPL-1</b>
PNP - NO and NC	<b>EC3025PPASL</b>	<b>EC3025PPASL-1</b>	<b>EC3025PPAPL</b>	<b>EC3025PPAPL-1</b>
<b>Characteristics flush and non-flush mountable</b>				
Rated operating voltage	10 - 40 VDC	10 - 40 VDC	10 - 40 VDC	10 - 40 VDC
Voltage drop	≤ 2.5 VDC	≤ 2.5 VDC	≤ 2.5 VDC	≤ 2.5 VDC
Degree of protection	IP 67	IP 67	IP 67	IP 67
Protection Short-circuit (S)				
Reverse polarity (P)	SPT	SPT	SPT	SPT
Transients (T)				
Output current	< 200 mA	< 200 mA	< 200 mA	< 200 mA
Housing material	Stainless steel	Stainless steel	Thermoplastic polyester	Thermoplastic polyester
Operating temperature	-25°C to +80°C	-25°C to +80°C	-25°C to +80°C	-25°C to +80°C
LED colour	Yellow	Yellow	Yellow	Yellow
Approvals/Marks	CE - UL - CSA	CE - UL - CSA	CE - UL - CSA	CE - UL - CSA

# Capacitive proximity sensors, TRIPLESIELD™

## Types

### M30-AC TRIPLESIELD™

**Connections**      **2 m cable**      **M12 connector**      **2 m cable**      **M12 connector**

#### Flush mountable



Dimensions (mm)	M30 x 63.6	M30 x 63.6	M30 x 63.6	M30 x 63.6
Thread (mm)	M30 x 1.5 x 50	M30 x 1.5 x 50	M30 x 1.5 x 50	M30 x 1.5 x 50
Operating frequency	10 Hz	10 Hz	10 Hz	10 Hz
Sensing distance (Sn)	2 - 16 mm (adjustable)	2 - 16 mm (adjustable)	2 - 16 mm (adjustable)	2 - 16 mm (adjustable)

#### References

Thyristor (SCR) NO or NC      **EC3016TBAPL**      **EC3016TBAPL-6**      **EC3016TBASL**      **EC3016TBASL-6**

#### Non-flush mountable



Dimensions (mm)	M30 x 75.6	M30 x 75.6	M30 x 75.6	M30 x 75.6
Thread (mm)	M30 x 1.5 x 50	M30 x 1.5 x 50	M30 x 1.5 x 50	M30 x 1.5 x 50
Operating frequency	10 Hz	10 Hz	10 Hz	10 Hz
Sensing distance (Sn)	4 - 25 mm (adjustable)	4 - 25 mm (adjustable)	4 - 25 mm (adjustable)	4 - 25 mm (adjustable)



#### References

Thyristor (SCR) NO or NC      **EC3025TBAPL**      **EC3025TBAPL-6**      **EC3025TBASL**      **EC3025TBASL-6**



#### Characteristics flush and non-flush mountable

Rated operating voltage	20 - 250 VAC	20 - 250 VAC	20 - 250 VAC	20 - 250 VAC
Voltage drop	< 10 VAC	< 10 VAC	< 10 VAC	< 10 VAC
Degree of protection	IP 67	IP 67	IP 67	IP 67
Protection Short-circuit (S)				
Reverse polarity (P)	T	T	T	T
Transients (T)				
Output current	< 500 mA	< 500 mA	< 500 mA	< 500 mA
Housing material	Thermoplastic polyester	Thermoplastic polyester	Stainless steel	Stainless steel
Operating temperature	-25°C to +80°C	-25°C to +80°C	-25°C to +80°C	-25°C to +80°C
LED colour	Yellow	Yellow	Yellow	Yellow
Approvals/Marks	CE - UL - CSA	CE - UL - CSA	CE - UL - CSA	CE - UL - CSA

## Capacitive proximity sensors, TRIPLESIELD™

Types	M12 teach-in TRIPLESIELD™		M18 teach-in TRIPLESIELD™	
Connections	2 m cable	M12 connector	2 m cable	M12 connector
<b>Flush Mountable</b>				
Dimensions (mm)	M12 x 82.4	M12 x 84.7	M18 x 89.55	M18 x 89.2
Thread (mm)	M12 x 1 x 50	M12 x 1 x 50	M18 x 1 x 50	M18 x 1 x 50
Operating frequency	15 Hz	15 Hz	15 Hz	15 Hz
Sensing distance (Sn)	0.5 - 8 mm (Teach-in)	0.5 - 8 mm (Teach-in)	0.2 - 12 mm (Teach-in)	0.2 - 12 mm (Teach-in)
<b>References</b>				
NPN/PNP, NO/NC	CA12CLC08BP	CA12CLC08BPM1	CA18CLC12BP	CA18CLC12BPM1
<b>Characteristics flush and non-flush mountable</b>				
Rated operating voltage	10 - 40 VDC	10 - 40 VDC	10 - 40 VDC	10 - 40 VDC
Voltage drop	< 2.5 VDC	< 2.5 VDC	< 2.5 VDC	< 2.5 VDC
Degree of protection	IP 68	IP 68	IP 68	IP 68
Protection Short-circuit (S) Reverse polarity (P) Transients (T)	SPT	SPT	SPT	SPT
Output current	< 250 mA	< 250 mA	< 250 mA	< 250 mA
Housing material	Thermoplastic polyester	Thermoplastic polyester	Thermoplastic polyester	Thermoplastic polyester
Operating temperature	-25°C to +85°C	-25°C to +85°C	-25°C to +85°C	-25°C to +85°C
Special features	Teach-in , Humidity compensation NPN/PNP auto detection, remote setup, alarm output. On request: Dirt and moisture compensation	Teach-in , Humidity compensation NPN/PNP auto detection, remote setup, alarm output. On request: Dirt and moisture compensation	Teach-in , Humidity compensation NPN/PNP auto detection, remote setup, alarm output. On request: Dirt and moisture compensation	Teach-in , Humidity compensation NPN/PNP auto detection, remote setup, alarm output. On request: Dirt and moisture compensation
Approvals/Marks	CE - UL - CSA	CE - UL - CSA	CE - UL - CSA	CE - UL - CSA

# Capacitive proximity sensors, TRIPLESIELD™

Types	M30 teach-in TRIPLESIELD™		M30 AC/DC TRIPLESIELD™	
Connections	2 m cable	M12 connector	2 m cable	M12 connector
<b>Flush mountable</b>				
Dimensions (mm)	M30 x 99.2	M30 x 90.45	M30 x 63.6	M30 x 75.6
Thread (mm)	M30 x 1.5 x 50	M30 x 1.5 x 50	M30 x 1.5 x 50	M30 x 1.5 x 50
Operating frequency	15 Hz	15 Hz	10 Hz	10 Hz
Sensing distance (Sn)	0.5 - 30 mm (Teach-in)	0.5 - 30 mm (Teach-in)	2 - 16 mm (adjustable)	2 - 16 mm (adjustable)
<b>References</b>				
NPN/PNP, NO/NC	<b>CA30CLC30BP</b>	<b>CA30CLC30BPM1</b>		
Power MOFSET			<b>CA30CLF16CP</b>	<b>CA30CLF16CPM6</b>
<b>Non-flush mountable</b>				
Dimensions (mm)			M30 x 71.6	M30 x 83.6
Thread (mm)			M30 x 1.5 x 50	M30 x 1.5 x 50
Operating frequency			10 Hz	10 Hz
Sensing distance (Sn)			2 - 25 mm (adjustable)	2 - 25 mm (adjustable)
<b>References</b>				
Power MOFSET			<b>CA30CLN25CP</b>	<b>CA30CLN25CPM6</b>
<b>Characteristics flush and non-flush mountable</b>				
Rated operating voltage	10 - 40 VDC	10 - 40 VDC	20 - 250 VAC/DC	20 - 250 VAC/DC
Voltage drop	< 2.5 VDC	< 2.5 VDC	< 5.5 VAC/DC	< 5.5 VAC/DC
Degree of protection	IP 68	IP 68	IP 67	IP 67
Protection Short-circuit (S)				
Reverse polarity (P)	SPT	SPT	PT	PT
Transients (T)				
Output current	< 250 mA	< 250 mA	< 250 mA DC < 350 mA AC	< 250 mA DC < 350 mA AC
Housing material	Thermoplastic polyester	Thermoplastic polyester	Thermoplastic polyester	Thermoplastic polyester
Operating temperature	-20°C to +85°C	-20°C to +85°C	-25°C to +80°C	-25°C to +80°C
LED colour	Yellow	Yellow	Yellow	Yellow
Special features	Teach-in , Humidity compensation NPN/PNP auto detection, remote setup, alarm output. On request: Dirt and moisture compensation	Teach-in , Humidity compensation NPN/PNP auto detection, remote setup, alarm output. On request: Dirt and moisture compensation		
Approvals/Marks	CE - UL - CSA	CE - UL - CSA	CE - UL - CSA	CE - UL - CSA



# Capacitive proximity sensors, TRIPLESIELD™

**Types** M18 TRIPLESIELD™, chemical resistant

**Connections** 2 m cable 2 m cable 2 m cable

**Flush mountable**



Dimensions (mm)	M18 x 71.5	M18 x 71.5	M18 x 71.5
Thread (mm)	M18 x 1 x 46.5	M18 x 1 x 46.5	M18 x 1 x 46.5
Operating frequency	30 Hz	30 Hz	30 Hz
Sensing distance (Sn)	3 - 8 mm (adjustable)	3 - 8 mm (adjustable)	3 - 8 mm (adjustable)

**References**

NPN-NO/NC	CA18HLF08NA	CA18GLF08NA	CA18FLF08NA
PNP-NO/NC	CA18HLF08PA	CA18GLF08PA	CA18FLF08PA

**Non-flush mountable**



Dimensions (mm)	M18 x 71.5
Thread (mm)	M18 x 1 x 46.5
Operating frequency	30 Hz
Sensing distance (Sn)	3 - 12 mm (adjustable)





**References**

NPN-NO/NC	CA18HLN12NA
PNP-NO/NC	CA18HLN12PA



**Characteristics flush and non-flush mountable**

Rated operating voltage	10 - 40 VDC	10 - 40 VDC	10 - 40 VDC
Voltage drop	≤ 2.5 VDC	≤ 2.5 VDC	≤ 2.5 VDC
Degree of protection	IP 67	IP 67	IP 67
Protection Short-circuit (S)			
Reverse polarity (P)	SPT	SPT	SPT
Transients (T)			
Output current	< 200 mA	< 200 mA	< 200 mA
Housing material	Polypropylene	PVC	Teflon
Operating temperature	-25°C to +80°C	-25°C to +80°C	-25°C to +80°C
LED colour	Yellow	Yellow	Yellow
Approvals/Marks	CE	CE	CE

# Capacitive proximity sensors, TRIPLESIELD™

Types	VC5510	VC5510 Time delay	CD50	
Connections	1.5 m cable	1.5 m cable	2 m cable	2 m cable
<b>Flush mountable</b>				
Dimensions (mm)	55 x 35 x 15	55 x 35 x 15	50 x 30 x 7	50 x 30 x 7
Operating frequency	> 15 Hz	> 0.1 Hz	10 Hz	10 Hz
Sensing distance (Sn)	10 mm	10 mm	6 mm	5 mm
<b>References</b>				
NPN - NO	<b>VC5510NNOP</b>	<b>VC5510NNOPT</b>	<b>CD50CNF06NO</b>	<b>CD50CNF05NO</b>
NPN - NC	<b>VC5510NNCP</b>	<b>VC5510NNCPT</b>		
PNP - NO	<b>VC5510PNOP</b>	<b>VC5510PNOPT</b>		
PNP - NC	<b>VC5510PNCP</b>	<b>VC5510PNCPT</b>		
Sensing distance (Sn)			7 mm	
PNP - NO			<b>CD50CNF07PO</b>	
NPN - NC			<b>CD50CNF07NC</b>	
Sensing distance (Sn)			10 mm	
PNP - NO			<b>CD50CNF10PO</b>	
NPN - NC			<b>CD50CNF10NC</b>	
<b>Characteristics flush and non-flush mountable</b>				
Rated operating voltage	5 - 30 VDC	5 - 30 VDC	10 - 30 VDC	5 VDC
Voltage drop	≤ 1.5 VDC	≤ 1.5 VDC	≤ 1.5 V	≤ 1.5 V
Degree of protection	IP 65	IP 65	IP 67	IP 67
Output current	≤ 100 mA	≤ 100 mA	≤ 50 mA	≤ 50 mA
Housing material	PC/ABS	PC/ABS	Noryl, grey	Noryl, grey
Operating temperature	0°C to +50°C	0°C to +50°C	0°C to +60°C	0°C to +60°C
LED colour	Red	Red		
Approvals/Marks	CE - UL	CE - UL	CE	CE

# Capacitive proximity sensors, TRIPLESIELD™

Types	CD46 teach-in TRIPLESIELD™	EC 5525 TRIPLESIELD™	
Connections	2 m cable	2 m cable	M12 connector
<b>Flush or non-Flush mountable</b>			
Dimensions (mm)	46 x 28 x 5.5	55 x 35 x 15	55 x 35 x 15
Operating frequency	10 Hz	50 Hz	50 Hz
Sensing distance (Sn)	1.0 - 10 mm (Teach-in)	4 - 25 mm	4 - 25 mm
<b>References</b>			
NPN-NO/NC	CD46CNC10NP	EC5525NPAP	EC5525NPAP-1
PNP-NO/NC	CD46CNC10PP	EC5525PPAP	EC5525PPAP-1
<b>Characteristics flush and non-flush mountable</b>			
Rated operating voltage	10 - 30 VDC	10 - 40 VDC	10 - 40 VDC
Voltage drop	≤ 2.5 VDC	≤ 2.5 VDC	≤ 2.5 VDC
Degree of protection	IP 68	IP 67	IP 67
Protection Short-circuit (S)			
Reverse polarity (P)	SPT	SPT	SPT
Transients (T)			
Output current	≤ 200 mA	≤ 200 mA	≤ 200 mA
Housing material	PBT	Polycarbonate	Polycarbonate
Operating temperature	-25°C to +80°C	-25°C to +80°C	-25°C to +80°C
LED colour	Yellow, Green	Yellow	Yellow
Special features	Teach-in, remote setup, alarm output.		
Approvals/Marks	CE - UL - CSA	CE - UL - CSA	CE - UL - CSA

# Capacitive proximity sensors, TRIPLESIELD™

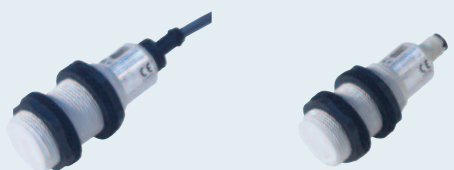
Types	M18 teach-in TRIPLESIELD™		M30 teach-in TRIPLESIELD™		
Connections	2 m cable	M12 connector	2 m cable	M12 connector	
Flush or non-flush mountable					
	Dimensions (mm)	M18 x 89.55	M18 x 89.2	M30 x 99.2	M30 x 99.45
	Thread (mm)	M18 x 1 x 50	M18 x 1 x 50	M30 x 1.5 x 50	M30 x 1.5 x 50
	Operating frequency	5 Hz	5 Hz	5 Hz	5 Hz
	Sensing distance (Sn)	0.5 - 12 mm (Teach-in)	0.5 - 12 mm (Teach-in)	0.5 - 30 mm (Teach-in)	0.5 - 30 mm (Teach-in)
<b>References</b>					
NPN/PNP, NO/NC	CA18CLL12BP	CA18CLL12BPM1	CA30CLL30BP	CA30CLL30BPM1	
<b>Characteristics flush and non-flush mountable</b>					
Rated operating voltage	10 - 40 VDC	10 - 40 VDC	10 - 40 VDC	10 - 40 VDC	
Voltage drop	≤ 2.5 VDC	≤ 2.5 VDC	≤ 2.5 VDC	≤ 2.5 VDC	
Degree of protection	IP 68	IP 68	IP 68	IP 68	
Output current	≤ 250 mA	≤ 250 mA	≤ 250 mA	≤ 250 mA	
Housing material	Thermoplastic polyester	Thermoplastic polyester	Thermoplastic polyester	Thermoplastic polyester	
Operating temperature	-20°C to +85°C	-20°C to +85°C	-20°C to +85°C	-20°C to +85°C	
Max. temperature on sensing face	120°C (248°F)	120°C (248°F)	120°C (248°F)	120°C (248°F)	
LED colour	Yellow	Yellow	Yellow	Yellow	
Special features	Single-step Teach-in, Humidity compensation NPN/PNP auto detection, remote setup, alarm output. On request: Dirt and moisture compensation	Single-step Teach-in, Humidity compensation NPN/PNP auto detection, remote setup, alarm output. On request: Dirt and moisture compensation	Single-step Teach-in, Humidity compensation NPN/PNP auto detection, remote setup, alarm output. On request: Dirt and moisture compensation	Single-step Teach-in, Humidity compensation NPN/PNP auto detection, remote setup, alarm output. On request: Dirt and moisture compensation	
Approvals/Marks	CE - UL - CSA	CE - UL - CSA	CE - UL - CSA	CE - UL - CSA	

# Capacitive level sensors

**Types** Ø32 capacitive level sensors for solid, fluid and granulated substances

**Connections**      **With ON delay**                      **With OFF delay**                      **Without delay**



Dimensions (mm)	Ø32 x 101	Ø32 x 101	Ø32 x 101
Thread	Smooth	Smooth	Smooth
Operating frequency	1 Hz	1 Hz	1 Hz
Sensing distance (Sn)	4 - 12 mm (adjustable)	4 - 12 mm (adjustable)	4 - 12 mm (adjustable)



## References

120 VAC	<b>VC11RT12010M</b>	<b>VC12RT12010M</b>	<b>VC12RN120</b>
230 VAC	<b>VC11RT23010M</b>	<b>VC12RT23010M</b>	<b>VC12RN230</b>
24 VAC/DC	<b>VC11RT92410M</b>	<b>VC12RT92410M</b>	<b>VC12RN924</b>

## Specifications

Consumption	< 1.5 W	< 1.5 W	< 1.5 W
Hysteresis	1.5 mm at 7 mm sensing distance	1.5 mm at 7 mm sensing distance	1.5 mm at 7 mm sensing distance
Output	Relay SPDT 2 A / 240 VAC	Relay SPDT 2 A / 240 VAC	Relay SPDT 2 A / 240 VAC
Time delay	1 s - 10 m	1 s - 10 m	
Degree of protection	IP 68	IP 67	IP 67
Housing material	Thermoplastic polyester	Thermoplastic polyester	Thermoplastic polyester
Operating temperature	-20°C to +70°C	-20°C to +70°C	-20°C to +70°C
LED colour	Yellow	Yellow	Yellow
Approvals/Marks	CE	CE - CSA	CE

# Capacitive level sensors

	Ø18 sensors for solid, fluid and granulated substances		Ø32 sensors
Types	2-wire, AC	3-wire, DC	2-wire, AC
Connections	2 m cable	2 m cable	2 m cable
			
Dimensions (mm)	Ø18 x 86	Ø18 x 86	Ø32 x 101
Thread	Smooth	Smooth	Smooth
Operating frequency	10 Hz	30 Hz	10 Hz
Sensing distance (Sn)	3 - 12 mm (adjustable)	3 - 12 mm (adjustable)	2 - 20 mm (adjustable)
<b>References</b>			
Thyristor (SCR) NO	<b>CB18CLN12TOFT</b>		
Thyristor (SCR) NO ATEX	<b>CB18CLN12TOFTAX</b>		
Thyristor (SCR) NC	<b>CB18CLN12TCFT</b>		
Thyristor (SCR) NC ATEX	<b>CB18CLN12TCFTAX</b>		
NPN - NO/NC		<b>CB18CLN12NA</b>	
NPN - NO/NC ATEX		<b>CB18CLN12NAAX</b>	
PNP - NO/NC		<b>CB18CLN12PA</b>	
PNP - NO/NC ATEX		<b>CB18CLN12PAAX</b>	
ON-delay			No
Thyristor (SCR) NO			<b>CB32CLN12TO</b>
Thyristor (SCR) NO ATEX			<b>CB32CLN12TOAX</b>
Thyristor (SCR) NC			<b>CB32CLN12TC</b>
Thyristor (SCR) NC ATEX			<b>CB32CLN12TCAX</b>
ON-delay			Yes
Thyristor (SCR) NO			<b>CB32CLN12TOFT</b>
Thyristor (SCR) NO ATEX			<b>CB32CLN12TOFTAX</b>
Thyristor (SCR) NC			<b>CB32CLN12TCFT</b>
Thyristor (SCR) NC ATEX			<b>CB32CLN12TCFTAX</b>
<b>Specifications</b>			
Rated operating voltage	20 - 250 VAC	10 - 40 VDC	20 - 250 VAC
Voltage drop	≤ 10 VAC	≤ 10 VAC	≤ 10 VAC
Time delay	30 s ON-delay		30 s ON-delay
Degree of protection	IP 67	IP 67	IP 67
Protection Short-circuit (S)			
Reverse polarity (P)	T	SPT	T
Transients (T)			
Output current	≤ 500 mA	≤ 200 mA	≤ 500 mA
Housing material	Thermoplastic polyester	Thermoplastic polyester	Thermoplastic polyester
Operating temperature	-25°C to +80°C	-25°C to +80°C	-20°C to +70°C
LED colour	Yellow	Yellow	Yellow
Approvals/Marks	CE - UL - CSA - ATEX	CE - UL - CSA - ATEX	CE - UL - CSA - ATEX

# Capacitive level sensors

## Types Ø32 level sensors TRIPLESIELD™ - ATEX

Functions	With ON delay	With OFF delay	Without time delay
-----------	---------------	----------------	--------------------

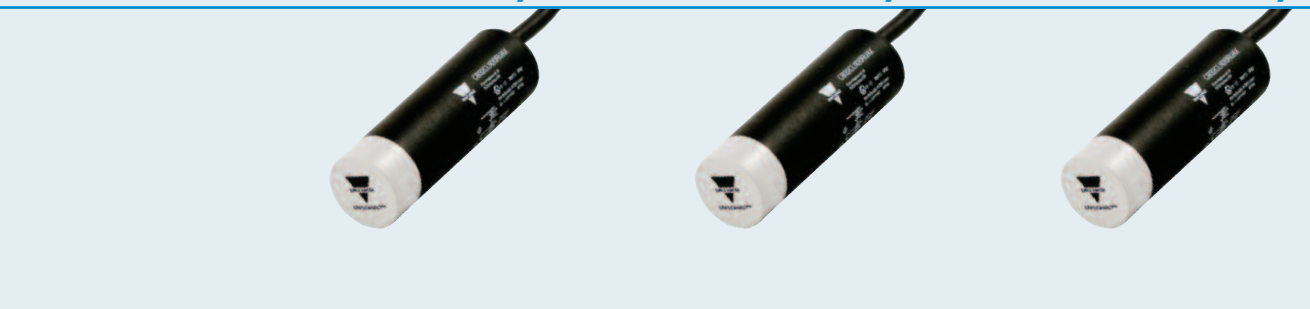

Dimensions (mm)	Ø32 x 101	Ø32 x 101	Ø32 x 101
Thread	Smooth	Smooth	Smooth
Operating frequency	5 Hz	5 Hz	5 Hz
Sensing distance (Sn)	4 - 20 mm (adjustable)	4 - 20 mm (adjustable)	4 - 20 mm (adjustable)

### References

Cable length	2 m	2 m	2 m
120 VAC	<b>CB32CLN20SUAX</b>	<b>CB32CLN20SVAX</b>	<b>CB32CLN20STAX</b>
230 VAC	<b>CB32CLN20RUAX</b>	<b>CB32CLN20RVAX</b>	<b>CB32CLN20RTAX</b>
24 VAC/DC	<b>CB32CLN20QUAX</b>	<b>CB32CLN20QVAX</b>	<b>CB32CLN20QTAX</b>
Cable length	5 m	5 m	5 m
120 VAC	<b>CB32CLN20SUAX5M</b>	<b>CB32CLN20SVAX5M</b>	<b>CB32CLN20STAX5M</b>
230 VAC	<b>CB32CLN20RUAX5M</b>	<b>CB32CLN20RVAX5M</b>	<b>CB32CLN20RTAX5M</b>
24 VAC/DC	<b>CB32CLN20QUAX5M</b>	<b>CB32CLN20QVAX5M</b>	<b>CB32CLN20QTAX5M</b>
Cable length	10 m	10 m	10 m
120 VAC	<b>CB32CLN20SUAX10M</b>	<b>CB32CLN20SVAX10M</b>	<b>CB32CLN20STAX10M</b>
230 VAC	<b>CB32CLN20RUAX10M</b>	<b>CB32CLN20RVAX10M</b>	<b>CB32CLN20RTAX10M</b>
24 VAC/DC	<b>CB32CLN20QUAX10M</b>	<b>CB32CLN20QVAX10M</b>	<b>CB32CLN20QTAX10M</b>

### Specifications

Consumption	< 1.5 W	< 1.5 W	< 1.5 W
Hysteresis	3 to 20% of sensing distance	3 to 20% of sensing distance	3 to 20% of sensing distance
Output	Relay SPDT, 2 A / 240 VAC	Relay SPDT, 2 A / 240 VAC	Relay SPDT, 2 A / 240 VAC
Time delay	1 s - 10 m	1 s - 10 m	
Degree of protection	IP 67	IP 67	IP 67
Housing material	PBT	PBT	PBT
Operating temperature	-20°C to +70°C	-20°C to +70°C	-20°C to +70°C
LED colour	Yellow	Yellow	Yellow
Approvals/Marks	CE - ATEX	CE - ATEX	CE - ATEX

## Conductive level sensors

Types	VN / VNI	VNY / VNYI	VPC	VPP				
Connections	Cable (PVC) 2 m	Screw connection	Screw connection	Screw connection				
								
<b>Electrodes</b>								
Number of electrodes	1, 2, 3 or 4	1, 2, 3 or 4	1, 2 or 3	1, 2 or 3				
Diameter/length (mm)	D5/1000	D5/1000	D4/500	D4/500				
Material	Stainless steel	Stainless steel	Stainless steel	Stainless steel				
Isolation of electrodes	Yes (VNI)	Yes (VNI)	Yes	Yes				
Isolation	Polyethylene	Polyethylene	Polyethylene	Polyethylene				
<b>Housing</b>								
Pipe thread	1½"	1½"	1½" (VPC x05) or 1" (VPC x10)	1½" (VPC x05) or 1" (VPC x10)				
Material	Nylon 6	Nylon 6	PVC	Kynar (PVDF)				
<b>References</b>								
1 electrodes	<b>VN1</b>	<b>VNI1</b>	<b>VNY1</b>	<b>VNYI1</b>	<b>VPC105</b>	<b>VPC110</b>	<b>VPP105</b>	<b>VPP110</b>
2 electrodes	<b>VN2</b>	<b>VNI2</b>	<b>VNY2</b>	<b>VNYI2</b>	<b>VPC205</b>	<b>VPC210</b>	<b>VPP205</b>	<b>VPP210</b>
3 electrodes	<b>VN3</b>	<b>VNI3</b>	<b>VNY3</b>	<b>VNYI3</b>	<b>VPC310</b>		<b>VPP310</b>	
4 electrodes	<b>VN4</b>	<b>VNI4</b>	<b>VNY4</b>	<b>VNYI4</b>				
<b>Specifications</b>								
Degree of protection	IP 67	IP 67	IP 67	IP 67				
Operating temperature	0°C to +90°C	0°C to +90°C	0°C to +60°C	0°C to +100°C				
Approvals/Marks	CE	CE	CE	CE				



# Conductive level sensors

Types	VT / VTI	CLH	VH1 / VH2	A 94-10
-------	----------	-----	-----------	---------

Connections	Cable (Silicone)	Screw connection	Cable (Neoprene)	Cable (Neoprene)
-------------	------------------	------------------	------------------	------------------

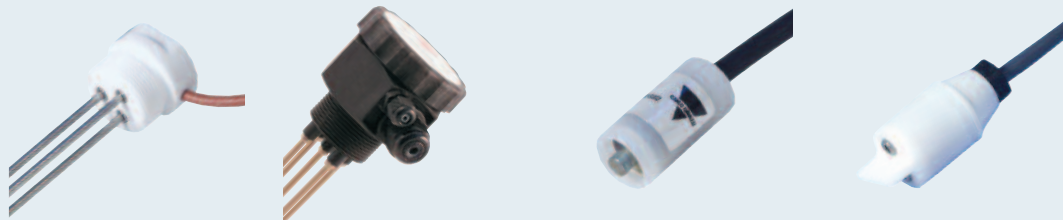

## Electrodes

Number of electrodes	1, 2, 3 or 4	2 or 4 + reference	1 (hanging)	2 (hanging)
Diameter/length (mm)	D5/1000	D5	D18/365 or D32/755	D22/750
Material	Stainless steel	Stainless steel	Stainless steel	Stainless steel
Isolation of electrodes	Yes (VNI)	Yes	No (VH1) - Yes (VH2)	No
Isolation	Teflon	Kynar, Polyolefine	Nylon 6	

## Housing

Pipe thread	1½"	1½"		
Material	Teflon	Polypropylene	Nylon 6	Polyester

## References

1 electrodes	<b>VT1</b>	<b>VTI1</b>	<b>VH1 or VH2</b>	
2 electrodes	<b>VT2</b>	<b>VTI2</b>		<b>A 94-10</b>
3 electrodes	<b>VT3</b>	<b>VTI3</b>		<b>CLH3*</b>
4 electrodes	<b>VT4</b>	<b>VTI4</b>		
5 electrodes				<b>CLH5*</b>

## Specifications



Degree of protection	IP 67	IP 65	IP 67	IP 67
Operating temperature	0°C to +145°C	-20°C to +90°C	0°C to +90°C	0°C to +60°C
Approvals/Marks	CE	CE	CE	CE

## Electrodes (Stainless steel ANSI316)

No Insulation	
1 m	CLE1
2 m	CLE2
Extension 1 m	CLE1X
Kynar (DVDP) Insulation	
1 m	CLE1K
2 m	CLE2K
Extension 1 m	CLE1XK
Polyolefine Insulation	
1 m	CLE1P
2 m	CLE2P
extension 1 m	CLE1XP



\* Electrodes shall be ordered separately

# Conductive level sensors



Level controller			
Types	CLD1	CLP2 basic	CLD2
Connections	DIN rail	Plug 11 pin circular	DIN rail
			
Function	Filling or emptying. Selectable by rotary switches. Conductive liquids	Filling or emptying. Selectable by rotary switches. Conductive liquids	Filling or emptying. Selectable by rotary switches. Conductive liquids
Adjustable	Yes, Potentiometer	Yes, Potentiometer	Yes, Potentiometer
Sensitivity	5 K $\Omega$ to 150 K $\Omega$	250 $\Omega$ to 500 K $\Omega$	250 $\Omega$ to 500 K $\Omega$
Functions switch	- Timer 1 to 30 sec. delay on filling or/and emptying	- Filling / Emptying - 3-levels: Low, Standard and High	- Filling / Emptying - 3-levels: Low, Standard and High
Input	1 + reference	2 + reference	2 + reference
Output	8A / 250 VAC SPDT	8A / 250 VAC SPDT	5A / 250 VAC DPDT
Power Supply	24 V AC/DC	24 VAC/DC, 115 VAC or 230 VAC	24 VAC/DC, 115 VAC or 230 VAC
<b>References</b>			
24 VAC/DC	<b>CLD1EA1CM24</b>	<b>CLP2EA1CM24</b>	<b>CLD2EA1CM24</b>
115 VAC/DC		<b>CLP2EA1C115</b>	<b>CLD2EA1C115</b>
230 VAC/DC		<b>CLP2EA1C230</b>	<b>CLD2EA1C230</b>
<b>Specifications</b>			
Time delay	< 300 mS	< 300 mS	< 300 mS
Housing material	NORYL SE1	NORYL SE1	NORYL SE1
Operating temperature	-20°C to +70°C	-20°C to +70°C	-20°C to +70°C
Output LED colour	Yellow	Yellow	Yellow
Power LED colour	Green	Green	Green
Approvals/Marks	CE - UL - CSA	CE - UL - CSA	CE - UL - CSA

# Conductive level sensors

## Level controller

Types	CLP2	CLD4	CLP4
Connections	Plug 11 pin circular	DIN rail	Plug 11 pin circular
			
Function	Filling or emptying. Selectable by rotary switches. Conductive liquids Master - Slave system	Filling, emptying or combinations. Selectable by rotary switches. Conductive liquids	Filling, emptying or combinations. Selectable by rotary switches. Conductive liquids
Adjustable	Yes, Potentiometer	Yes, Potentiometer	Yes, Potentiometer
Sensitivity	250 Ω to 500 KΩ	250 Ω to 500 KΩ	250 Ω to 500 KΩ
Functions switch	- Filling / Emptying - 3-levels: Low, Standard and High	- Tank - well - Direct in to out 2 probe - Low and High alarm - 2 system in one, filling and/or emptying - 3-levels: Low, Standard and High - NO or NC	- Tank - well - Direct in to out 2 probe - Low and High alarm - 2 system in one, filling and/or emptying - 3-levels: Low, Standard and High - NO or NC
Input	2 + reference	2 + reference	2 + reference
Output	5A / 250 VAC DPDT	8A / 250 VAC SPDT, SPST	8A / 250 VAC DPDT, SPST
Power Supply	24 VAC/DC, 115 VAC or 230 VAC	24 VAC/DC, 115 VAC or 230 VAC	24 VAC/DC, 115 VAC or 230 VAC
<b>References</b>			
24 VAC/DC	<b>CLP2FA1CM24</b>	<b>CLD4MA2DM24</b>	<b>CLP4MA2AM24</b>
115 VAC/DC	<b>CLP2FA1C115</b>	<b>CLD4MA2D115</b>	<b>CLP4MA2A115</b>
230 VAC/DC	<b>CLP2FA1C230</b>	<b>CLD4MA2D230</b>	<b>CLP4MA2A230</b>
<b>Specifications</b>			
Time delay	< 300 mS	< 300 mS	< 300 mS
Housing material	NORYL SE1	NORYL SE1	NORYL SE1
Operating temperature	-20°C to +70°C	-20°C to +70°C	-20°C to +70°C
Output LED colour	Yellow	Yellow	Yellow
Power LED colour	Green	Green	Green
Approvals/Marks	CE - UL - CSA	CE - UL - CSA	CE - UL - CSA

## Ultrasonic sensors, M18 plastic, DC, analogue

	Integrated amplifier switching output		Basic analogue 0-10 VDC or 4-20 mA	
Types	UA18CL..	UA18CL..M1	UA18CLD..	UA18CLD..M1
Connections	2 m cable	M12 connector	2 m cable	M12 connector
				
Dimensions (mm)	M18 x 89	M18 x 97	M18 x 89	M18 x 97
<b>References diffuse reflective</b>				
Operating frequency	25 Hz	25 Hz		
Sensing distance (Sn)	100 - 600 mm adj.	100 - 600 mm adj.	100 - 600 mm adj.	100 - 600 mm adj.
Output slope			20 mV/mm	20 mV/mm
NPN-NO	<b>UA18CLD06NO</b>	<b>UA18CLD06NOM1</b>		
PNP-NO	<b>UA18CLD06PO</b>	<b>UA18CLD06POM1</b>		
0-10 VDC			<b>UA18CLD06AK</b>	<b>UA18CLD06AKM1</b>
Output slope			32 µA/mm	32 µA/mm
4-20 mA			<b>UA18CLD06AG</b>	<b>UA18CLD06AGM1</b>
Operating frequency	8 Hz	8 Hz		
Sensing distance (Sn)	200 - 1500 mm adj.	200 - 1500 mm adj.	200 - 1500 mm adj.	200 - 1500 mm adj.
Output slope			5.5 mV/mm	5.5 mV/mm
NPN-NO	<b>UA18CLD15NO</b>	<b>UA18CLD15NOM1</b>		
PNP-NO	<b>UA18CLD15PO</b>	<b>UA18CLD15POM1</b>		
0-10 VDC			<b>UA18CLD15AK</b>	<b>UA18CLD15AKM1</b>
Output slope			8.8 µA/mm	8.8 µA/mm
4-20 mA			<b>UA18CLD15AG</b>	<b>UA18CLD15AGM1</b>
<b>References true scan</b>				
Operating frequency		25 Hz		
Sensing distance (Sn)		100 - 600 mm adj.		
PNP-NO		<b>UA18CLS06POM1</b>		
Operating frequency		8 Hz		
Sensing distance (Sn)		200 - 1500 mm adj.		
PNP-NO		<b>UA18CLS15POM1</b>		
<b>Specifications</b>				
Rated operating voltage	18 - 30 VDC	18 - 30 VDC	18 - 30 VDC	18 - 30 VDC
Voltage drop	PNP: 2.5 VDC NPN: 1.6 VDC	PNP: 2.5 VDC NPN: 1.6 VDC		
Degree of protection	IP 67	IP 67	IP 67	IP 67
Protection Short-circuit (S)				
Reverse polarity (P)	SPT	SPT	SPT	SPT
Transients (T)				
Load current	< 500 mA	< 500 mA	See sensor type	See sensor type
Housing material	PBTB	PBTB	PBTB	PBTB
Operating temperature	-15°C to +70°C	-15°C to +70°C	-15°C to +70°C	-15°C to +70°C
LED colour	Yellow	Yellow	Yellow	Yellow
Approvals/Marks	CE - UL - cUL	CE - UL - cUL	CE - UL - cUL	CE - UL - cUL

# Ultrasonic sensors, M30 plastic, DC, analogue

	Integrated Amplifier switching output		Basic analogue 0-10 VDC or 4-20 mA	
<b>Types</b>	<b>UA30CLD..</b>	<b>UA30CLD..M1</b>	<b>UA30CLD..</b>	<b>UA30CLD..M1</b>
<b>Connections</b>	<b>2 m cable</b>	<b>M12 connector</b>	<b>2 m cable</b>	<b>M12 connector</b>
				
Dimensions (mm)	M30 x 125	M30 x 137	M30 x 125	M30 x 137
<b>References diffuse reflective</b>				
Operating frequency	1 Hz	1 Hz		
Sensing distance (Sn)	300 - 2500 mm adj.	300 - 2500 mm adj.	300 - 2500 mm adj.	300 - 2500 mm adj.
Output slope			3.7 mV/mm	3.7 mV/mm
NPN-NO	<b>UA30CLD25NO</b>	<b>UA30CLD25NOM1</b>		
PNP-NO	<b>UA30CLD25PO</b>	<b>UA30CLD25POM1</b>		
0-10 VDC			<b>UA30CLD25AK</b>	<b>UA30CLD25AKM1</b>
Output slope			5.9 µA/mm	5.9 µA/mm
4-20 mA			<b>UA30CLD25AG</b>	<b>UA30CLD25AGM1</b>
<b>References true scan</b>				
Operating frequency		1 Hz		
Sensing distance (Sn)		300 - 2500 mm adj.		
PNP-NO		<b>UA30CLS25POM1</b>		
<b>Specifications</b>				
Rated operating voltage	18 - 30 VDC	18 - 30 VDC	18 - 30 VDC	18 - 30 VDC
Voltage drop	≤ 2.5 VDC	≤ 2.5 VDC		
Degree of protection	IP 67	IP 67	IP 67	IP 67
Protection Short-circuit (S)				
Reverse polarity (P)	SPT	SPT	SPT	SPT
Transients (T)				
Load current	< 500 mA	< 500 mA	See sensor type	See sensor type
Housing material	PBTB	PBTB	PBTB	PBTB
Operating temperature	-15°C to +70°C	-15°C to +70°C	-15°C to +70°C	-15°C to +70°C
LED colour	Yellow	Yellow	Yellow	Yellow
Approvals/Marks	CE - UL - cUL	CE - UL - cUL	CE - UL - cUL	CE - UL - cUL

## Ultrasonic sensors, M18 plastic, DC, analogue

	Programmable RS232	Integrated amplifier	Sensor head for UC EU 80-1	Amplifier for UC80CND
<b>Types</b>	<b>UA30CLD..M7</b>	<b>UA30CLD...TI</b>	<b>UC80CND80FS..</b>	<b>UCEU80-1</b>
<b>Connections</b>	<b>M16 connector</b>	<b>M12 connector</b>	<b>M12 connector</b>	<b>Terminals</b>



Dimensions (mm)	M30 x 136	M30 x 128	80 x 80 x 43	100 x 75 x 110
-----------------	-----------	-----------	--------------	----------------

### References diffuse reflective

Operating frequency	5 - 30 Hz Programmable	1 Hz	See Amplifier
Sensing distance (Sn)	150 - 1500 mm adj.	150 - 1500 mm Teach	800 - 8000 mm
0-10 VDC	<b>UA30CLD15FKM7</b>	<b>UA30CLD15AKM1TI</b>	
Sensor head			<b>UC80CND80FSM1</b>
4-20 mA	<b>UA30CLD15FGM7</b>		
Operating frequency	5 - 30 Hz Programmable	1 Hz	
Sensing distance (Sn)	250 - 2000 mm adj.	250 - 2000 mm Teach	
PNP-NO		<b>UA30CLD20POM1TI</b>	
0-10 VDC	<b>UA30CLD20FKM7</b>	<b>UA30CLD20AKM1TI</b>	
4-20 mA	<b>UA30CLD20FGM7</b>	<b>UA30CLD20AGM1TI</b>	
Operating frequency	5 - 30 Hz Programmable	1 Hz	
Sensing distance (Sn)	350 - 3500 mm adj.	350 - 3500 mm adj.	
0-10 VDC	<b>UA30CLD35FKM7</b>	<b>UA30CLD35AKM1TI</b>	
4-20 mA	<b>UA30CLD35FGM7</b>		

### Amplifier

Evaluation unit			<b>UCEU80-1</b>
PLC			
Display			BCD, HEX
RS232			
Sensor supply			
Programmable functions			Full setup

### Specifications

Rated operating voltage	19 - 30 VDC	19 - 30 VDC	19 - 30 VDC	19 - 30 VDC
Voltage drop	≤ 2.5 VDC	≤ 2.5 VDC		≤ 2.5 VDC
Degree of protection	IP 67	IP 67	IP 67	IP 40
Protection Short-circuit (S) Reverse polarity (P) Transients (T)	SPT	SPT	SPT	SPT
Load current	< 100 mA Analogue see type	2 x transistor output < 100 mA Analogue see type	< 50 mA	< 200 mA
Housing material	PBTB	PBTB	PET	ABS
Operating temperature	-15°C to +70°C	-15°C to +70°C	0°C to +70°C	0°C to +50°C
LED colour	Yellow + Green	Yellow + Green	Yellow + Green	Yellow

Remarks	Hold/sync. input RS232	Teach Button		Two set points • Over range • Under range Analogue outputs: • 0 - 10 VDC • 4 - 20 mA
Approvals/Marks	CE - UL - cUL	CE - UL - cUL	CE - UL - cUL	CE - UL - cUL

# Ultrasonic sensors, M12, M18, remote teach

Integrated amplifier, switching output

Types	UA12CLD..M1TR	UA18CLD..TR	UA18CLD..M1TR
Connections	M12 connector	2 m cable	M12 connector

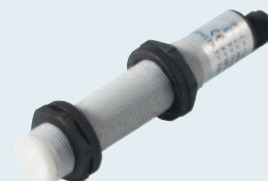
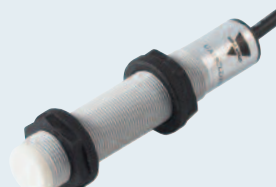

Dimensions (mm)	M12 x 79	M18 x 93	M18 x 93
-----------------	----------	----------	----------

## References diffuse reflective

Operating frequency	20 Hz	1.2 Hz	1.2 Hz
Sensing distance (Sn)	25 - 200 mm adj.	200 - 2000 mm adj.	200 - 2000 mm adj.
NPN-NO/NC	<b>UA12CLB02NPM1TR</b>	<b>UA18CLD20NPTR</b>	<b>UA18CLD20NPM1TR</b>
PNP-NO/NC	<b>UA12CLB02PPM1TR</b>	<b>UA18CLD20PPTR</b>	<b>UA18CLD20PPM1TR</b>
Operating frequency		4.7 Hz	4.7 Hz
Sensing distance (Sn)		100 - 800 mm adj.	100 - 800 mm adj.
NPN-NO/NC		<b>UA18CLD08NPTR</b>	<b>UA18CLD08NPM1TR</b>
PNP-NO/NC		<b>UA18CLD08PPTR</b>	<b>UA18CLD08PPM1TR</b>
Operating frequency		4.7 Hz	4.7 Hz
Sensing distance (Sn)		60 - 500 mm adj.	60 - 500 mm adj.
NPN-NO/NC		<b>UA18CLD05NPTR</b>	<b>UA18CLD05NPM1TR</b>
PNP-NO/NC		<b>UA18CLD05PPTR</b>	<b>UA18CLD05PPM1TR</b>

## Specifications

Rated operating voltage	10 - 30 VDC	12 - 30 VDC	12 - 30 VDC
Voltage drop	≤ 4.5 V	≤ 4.5 V	≤ 4.5 V
Degree of protection	IP 65	IP 67	IP 67
Protection Short-circuit (S)			
Reverse polarity (P)	SPT	SPT	SPT
Transients (T)			
Load current	< 100 mA	< 500 mA	< 500 mA
Housing material	Stainless Steel	PBTP	PBTP
Operating temperature	-20°C to +70°C	-15°C to +70°C	-15°C to +70°C
Approvals/Marks	CE	CE	CE

# Ultrasonic sensors, DC, remote teach

	Integrated Amplifier, switching output			Remote teach analogue, 0-10VDC or 4-20mA
Types	UA30CLD..TR	UA30CLD..M1TR	UC80CND	UC80CND60A.M1TR
Connections	2 m cable	M12 connector	M12 connector	M12 connector
				
Dimensions (mm)	M30 x 123.5	M30 x 125	80 x 80 x 50	80 x 80 x 50

## References diffuse reflective

Operating frequency	1 Hz	1 Hz	1 Hz	
Sensing distance (Sn)	300 - 3500 mm adj.	300 - 3500 mm adj.	600 - 6000 mm adj.	600 - 6000 mm
NPN-NO/NC	<b>UA30CLD35NPTR</b>	<b>UA30CLD35NPM1TR</b>	<b>UC80CND60NPM1TR</b>	
PNP-NO/NC	<b>UA30CLD35PPTR</b>	<b>UA30CLD35PPM1TR</b>	<b>UC80CND60PPM1TR</b>	
Output slope 0 - 10 VDC				Adjustable <b>UC80CND60AKM1TR</b>
Output slope 4 - 20 mA				Adjustable <b>UC80CND60AGM1TR</b>

## Specifications

Rated operating voltage	12 - 30 VDC	12 - 30 VDC	15 - 30 VDC	28 - 30 VDC
Voltage drop	≤ 4.5 V	≤ 4.5 V	≤ 4.5 V	
Degree of protection	IP 67	IP 67	IP 65	IP 65
Protection Short-circuit (S) Reverse polarity (P) Transients (T)	SPT	SPT	SPT	SPT
Load current	< 500 mA	< 500 mA	< 500 mA	See sensor type
Housing material	PBTP	PBTP	ABS	ABS
Operating temperature	-15°C to +70°C	-15°C to +70°C	-15°C to +70°C	-15°C to +70°C
Approvals/Marks	CE	CE	CE	CE

## Adapters

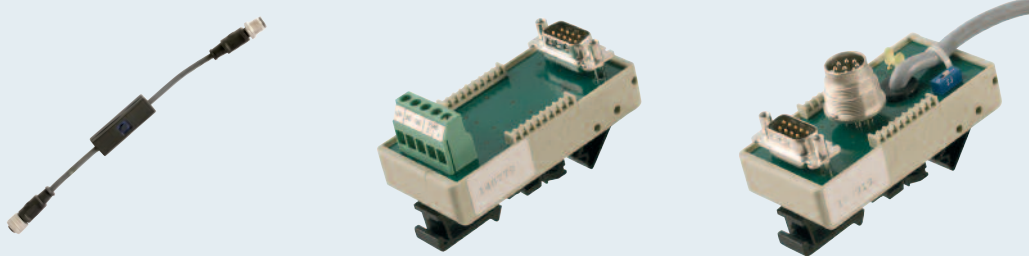
Types	AUA - RT	UCC	UCP1 and UCP2
Connections	M12 connector	Terminal block	Terminal block
			
Dimensions (mm)	17 x 56	38.5 x 80.5	38.5 x 80.5

## Specifications

Programming adapter for remote teach sensors ending with "RT"

RS232 to RS485 adapter

Programming adapter RS232



# Ultrasonic sensors, DC analogue, remote teach

Remote teach analogue, 0 - 10 VDC or 4 - 20 mA

Types	UA18CLD..TR	UA18CLD..M1TR	UA30CLD..TR	UA30CLD..M1TR
Connections	2 m cable	M12 connector	2 m cable	M12 connector

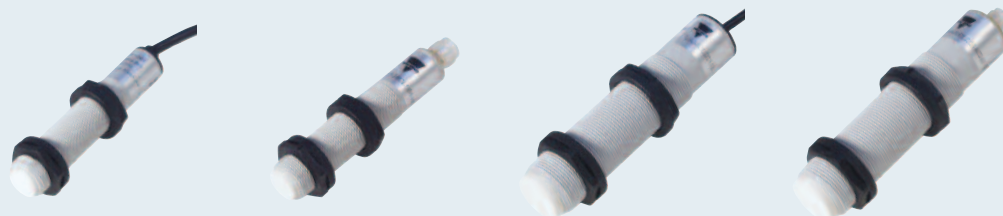

Dimensions (mm)	M18 x 93	M18 x 93	M30 x 123.5	M30 x 123.5
-----------------	----------	----------	-------------	-------------

## References diffuse reflective

Sensing distance (Sn)	200 - 2000 mm	200 - 2000 mm	300 - 3500 mm	300 - 3500 mm
Output slope	Adjustable	Adjustable	Adjustable	Adjustable
0-10 VDC	<b>UA18CLD20AKTR</b>	<b>UA18CLD20AKM1TR</b>	<b>UA30CLD35AKTR</b>	<b>UA30CLD35AKM1TR</b>
Output slope	Adjustable	Adjustable	Adjustable	Adjustable
4-20 mA	<b>UA18CLD20AGTR</b>	<b>UA18CLD20AGM1TR</b>	<b>UA30CLD35AGTR</b>	<b>UA30CLD35AGM1TR</b>
Sensing distance (Sn)	100 - 800 mm	100 - 800 mm		
Output slope	Adjustable	Adjustable		
0-10 VDC	<b>UA18CLD08AKTR</b>	<b>UA18CLD08AKM1TR</b>		
Output slope	Adjustable	Adjustable		
4-20 mA	<b>UA18CLD08AGTR</b>	<b>UA18CLD08AGM1TR</b>		
Sensing distance (Sn)	60 - 500 mm	60 - 500 mm		
Output slope	Adjustable	Adjustable		
0-10 VDC	<b>UA18CLD05AKTR</b>	<b>UA18CLD05AKM1TR</b>		
Output slope	Adjustable	Adjustable		
4-20 mA	<b>UA18CLD05AGTR</b>	<b>UA18CLD05AGM1TR</b>		

## Specifications

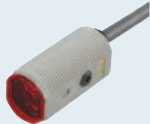
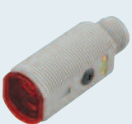
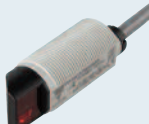
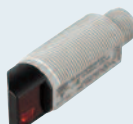

Rated operating voltage	18 - 30 VDC	18 - 30 VDC	18 - 30 VDC	18 - 30 VDC
Degree of protection	IP 67	IP 67	IP 67	IP 67
Protection Short-circuit (S)				
Reverse polarity (P)	SPT	SPT	SPT	SPT
Transients (T)				
Load current	See sensor type	See sensor type	See sensor type	See sensor type
Housing material	PBTP	PBTP	PBTP	PBTP
Operating temperature	-15°C to +70°C	-15°C to +70°C	-15°C to +70°C	-15°C to +70°C
Approvals/Marks	CE	CE	CE	CE

# Photoelectric sensors

	M18, DC, axial type		M18, DC, radial type	
Types	PA18CA.	PA18CA.	PA18CR.	PA18CR.
Connections	2 m cable	M12 connector	2 m cable	M12 connector
				
Dimensions (mm)	M18 x 40	M18 x 44	M18 x 50	M18 x 54
<b>Diffuse reflective</b>				
Operating frequency	500 Hz	500 Hz	500 Hz	500 Hz
Sensing distance (Sn)	50 - 1000 mm	50 - 1000 mm	50 - 800 mm	50 - 800 mm
NPN NO+NC	PA18CAD10NASA	PA18CAD10NAM1SA	PA18CRD08NASA	PA18CRD08NAM1SA
PNP NO+NC	PA18CAD10PASA	PA18CAD10PAM1SA	PA18CRD08PASA	PA18CRD08PAM1SA
<b>Retro reflective polariz.</b>				
Operating frequency	500 Hz	500 Hz	500 Hz	500 Hz
Sensing distance (Sn)	50 - 500 mm	50 - 500 mm	50 - 400 mm	50 - 400 mm
NPN NO+NC	PA18CAP50NASA	PA18CAP50NAM1SA	PA18CRP40NASA	PA18CRP40NAM1SA
PNP NO+NC	PA18CAP50PASA	PA18CAP50PAM1SA	PA18CRP40PASA	PA18CRP40PAM1SA
<b>Retro reflective</b>				
Operating frequency	500 Hz	500 Hz	500 Hz	500 Hz
Sensing distance (Sn)	50 - 650 mm	50 - 650 mm	50 - 500 mm	50 - 500 mm
NPN NO+NC	PA18CAR65NASA	PA18CAR65NAM1SA	PA18CRR50NASA	PA18CRR50NAM1SA
PNP NO+NC	PA18CAR65PASA	PA18CAR65PAM1SA	PA18CRR50PASA	PA18CRR50PAM1SA
<b>Through-beam emitter</b>				
Sensing distance (Sn)	1 - 20 m	1 - 20 m	1 - 16 m	1 - 16 m
	PA18CAT20	PA18CAT20M1	PA18CRT16	PA18CRT16M1
<b>Through-beam receiver</b>				
Operating frequency	500 Hz	500 Hz	500 Hz	500 Hz
Sensing distance (Sn)	1 - 20 m	1 - 20 m	1 - 16 m	1 - 16 m
NPN NO+NC	PA18CAT20NASA	PA18CAT20NAM1SA	PA18CRT16NASA	PA18CRT16NAM1SA
PNP NO+NC	PA18CAT20PASA	PA18CAT20PAM1SA	PA18CRT16PASA	PA18CRT16PAM1SA
<b>Specifications</b>				
Rated operating voltage	10 - 30 VDC	10 - 30 VDC	10 - 30 VDC	10 - 30 VDC
Voltage drop	≤ 2.0 VDC @ 100 mA	≤ 2.0 VDC @ 100 mA	≤ 2.0 VDC @ 100 mA	≤ 2.0 VDC @ 100 mA
Degree of protection	IP 67	IP 67	IP 67	IP 67
Protection Short-circuit (S) Reverse polarity (P) Transients (T)	SPT	SPT	SPT	SPT
Load current	≤ 20 mA @ 24 VDC	≤ 20 mA @ 24 VDC	≤ 20 mA @ 24 VDC	≤ 20 mA @ 24 VDC
Housing material	ABS, PMMA, PBTB	ABS, PMMA, PBTB	ABS, PMMA, PBTB	ABS, PMMA, PBTB
Operating temperature	-25°C to +60°C	-25°C to +60°C	-25°C to +60°C	-25°C to +60°C
LED colour	Yellow, Green	Yellow, Green	Yellow, Green	Yellow, Green
Approvals/Marks	CE - UL - ECOLAB	CE - UL - ECOLAB	CE - UL - ECOLAB	CE - UL - ECOLAB



# Photoelectric sensors

## M18, DC, square type



Types	PH18.	PH18.	PH18.
Connections	2 m cable	M12 connector	Pigtail M12
			
Dimensions (mm)	31,5 x 42,8	31,5 x 47,3	31,5 x 42,8
<b>Diffuse reflective</b>			
Operating frequency	500 Hz	500 Hz	500 Hz
Sensing distance (Sn)	50 - 1000 mm	50 - 1000 mm	50 - 1000 mm
NPN NO+NC	<b>PH18CND10NASA</b>	<b>PH18CND10NAM1SA</b>	<b>PH18CND10NAT1SA</b>
PNP NC+NC	<b>PH18CND10PASA</b>	<b>PH18CND10PAM1SA</b>	<b>PH18CND10PAT1SA</b>
<b>Retro reflective polariz.</b>			
Operating frequency	500 Hz	500 Hz	500 Hz
Sensing distance (Sn)	50 - 500 mm	50 - 500 mm	50 - 500 mm
NPN NO+NC	<b>PH18CNP50NASA</b>	<b>PH18CNP50NAM1SA</b>	<b>PH18CNP50NAT1SA</b>
PNP NO+NC	<b>PH18CNP50PASA</b>	<b>PH18CNP50PAM1SA</b>	<b>PH18CNP50PAT1SA</b>
<b>Retro reflective</b>			
Operating frequency	500 Hz	500 Hz	500 Hz
Sensing distance (Sn)	50 - 650 mm	50 - 650 mm	50 - 650 mm
NPN NO+NC	<b>PH18CNR65NASA</b>	<b>PH18CNR65NAM1SA</b>	<b>PH18CNR65NAT1SA</b>
PNP NO+NC	<b>PH18CNR65PASA</b>	<b>PH18CNR65PAM1SA</b>	<b>PH18CNR65PAT1SA</b>
<b>Through-beam emitter</b>			
Sensing distance (Sn)	1 - 20 m	1 - 20 m	1 - 20 m
	<b>PH18CNT20</b>	<b>PH18CNT20M1</b>	<b>PH18CNT20T1</b>
<b>Through-beam receiver</b>			
Operating frequency	500 Hz	500 Hz	500 Hz
Sensing distance (Sn)	1 - 20 m	1 - 20 m	1 - 20 m
NPN NO+NC	<b>PH18CNT20NASA</b>	<b>PH18CNT20NAM1SA</b>	<b>PH18CNT20NAT1SA</b>
PNP NO+NC	<b>PH18CNT20PASA</b>	<b>PH18CNT20PAM1SA</b>	<b>PH18CNT20PAT1SA</b>
<b>Specifications</b>			
Rated operating voltage	10 - 30 VDC	10 - 30 VDC	10 - 30 VDC
Voltage drop	≤ 2.0 VDC @ 100 mA	≤ 2.0 VDC @ 100 mA	≤ 2.0 VDC @ 100 mA
Degree of protection	IP 67	IP 67	IP 67
Protection Short-circuit (S) Reverse polarity (P) Transients (T)	SPT	SPT	SPT
Load current	≤ 20 mA @ 24 VDC	≤ 20 mA @ 24 VDC	≤ 20 mA @ 24 VDC
Housing material	ABS, PMMA	ABS, PMMA	ABS, PMMA
Operating temperature	-25°C to +60°C	-25°C to +60°C	-25°C to +60°C
LED colour	Yellow, Green	Yellow, Green	Yellow, Green
Approvals/Marks	CE - UL - ECOLAB	CE - UL - ECOLAB	CE - UL - ECOLAB

# Photoelectric sensors



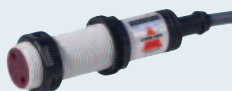
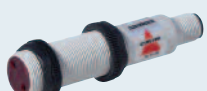

## M18 metal, DC, integrated amplifier

Types	E.18..	E.18..-1
Connections	2 m cable	M12 connector
		
Dimensions (mm)	M18 x 55	M18 x 67
<b>Diffuse reflective</b>		
Operating frequency	120 Hz	120 Hz
Sensing distance (Sn)	400 mm, adjustable	400 mm, adjustable
NPN NO+NC	<b>EO1804NPAS</b>	<b>EO1804NPAS-1</b>
PNP NC+NC	<b>EO1804PPAS</b>	<b>EO1804PPAS-1</b>
<b>Retro reflective polariz.</b>		
Operating frequency	100 Hz	100 Hz
Sensing distance (Sn)	2 m, adjustable	2 m, adjustable
NPN NO+NC	<b>EP1820NPAS</b>	<b>EP1820NPAS-1</b>
PNP NO+NC	<b>EP1820PPAS</b>	<b>EP1820PPAS-1</b>
<b>Retro reflective</b>		
Operating frequency	120 Hz	120 Hz
Sensing distance (Sn)	3 m, adjustable	3 m, adjustable
NPN NO+NC	<b>ER1830NPAS</b>	<b>ER1830NPAS-1</b>
PNP NO+NC	<b>ER1830PPAS</b>	<b>ER1830PPAS-1</b>
<b>Through-beam emitter</b>		
Sensing distance (Sn)	20 m	20 m
	<b>ET1820</b>	<b>ET1820-1</b>
<b>Through-beam receiver</b>		
Operating frequency	170 Hz	170 Hz
Sensing distance (Sn)	20 m, adjustable	20 m, adjustable
NPN NO+NC	<b>ET1820NPAS</b>	<b>ET1820NPAS-1</b>
PNP NO+NC	<b>ET1820PPAS</b>	<b>ET1820PPAS-1</b>
<b>Fiber optic</b>		
Operating frequency	120 Hz	120 Hz
Sensing distance (Sn)	Fibre dependent	Fibre dependent
NPN NO+NC	<b>EF1801NPAS</b>	<b>EF1801NPAS-1</b>
PNP NO+NC	<b>EF1801PPAS</b>	<b>EF1801PPAS-1</b>
<b>Specifications</b>		
Rated operating voltage	10 - 40 VDC	10 - 40 VDC
Voltage drop	≤ 2.5 VDC	≤ 2.5 VDC
Degree of protection	IP 67	IP 67
Protection Short-circuit(S) Rev. polarity(P)-Transients(T)	SPT	SPT
Load current	< 200 mA	< 200 mA
Housing material	Nickel-plated brass	Nickel-plated brass
Operating temperature	-20°C to +60°C	-20°C to +60°C
LED colour	Yellow	Yellow
Approvals/Marks	CE	CE





# Photoelectric sensors

	M18 plastic, AC, integrated amplifier		M18 metal, AC, integrated amplifier	
Types	PA18CL	PA18CL.M6	PA18AL	PA18AL..M6
Connections	2 m cable	M12 connector	2 m cable	M12 connector
				
Dimensions (mm)	M18 x 71.5	M18 x 83.5	M18 x 71.5	M18 x 83.5
<b>Diffuse reflective</b>				
Operating frequency	20 Hz	20 Hz	20 Hz	20 Hz
Sensing distance (Sn)	100 mm, fixed	100 mm, fixed		
Thyristor (SCR) NC	<b>PA18CLD01TC</b>	<b>PA18CLD01TCM6</b>		
Thyristor (SCR) NO	<b>PA18CLD01TO</b>	<b>PA18CLD01TOM6</b>		
Sensing distance (Sn)	200 mm, fixed	200 mm, fixed		
Thyristor (SCR) NC	<b>PA18CLD02TC</b>	<b>PA18CLD02TCM6</b>		
Thyristor (SCR) NO	<b>PA18CLD02TO</b>	<b>PA18CLD02TOM6</b>		
Sensing distance (Sn)	400 mm, fixed	400 mm, fixed		
Thyristor (SCR) NC	<b>PA18CLD04TC</b>	<b>PA18CLD04TCM6</b>		
Thyristor (SCR) NO	<b>PA18CLD04TO</b>	<b>PA18CLD04TOM6</b>		
Sensing distance (Sn)	400 mm, adjustable	400 mm, adjustable	400 mm, adjustable	400 mm, adjustable
Thyristor (SCR) NC	<b>PA18CLD04TCSA</b>	<b>PA18CLD04TCM6SA</b>	<b>PA18ALD04TCSA</b>	<b>PA18ALD04TCM6SA</b>
Thyristor (SCR) NO	<b>PA18CLD04TOSA</b>	<b>PA18CLD04TOM6SA</b>	<b>PA18ALD04TOSA</b>	<b>PA18ALD04TOM6SA</b>
<b>Retro reflective polariz.</b>				
Operating frequency	25 Hz	25 Hz	25 Hz	25 Hz
Sensing distance (Sn)	2 m, fixed	2 m, fixed	2 m, adjustable	2 m, adjustable
Thyristor (SCR) NC	<b>PA18CLP20TC</b>	<b>PA18CLP20TCM6</b>	<b>PA18ALP20TCSA</b>	<b>PA18ALP20TCM6SA</b>
Thyristor (SCR) NO	<b>PA18CLP20TO</b>	<b>PA18CLP20TOM6</b>	<b>PA18ALP20TOSA</b>	<b>PA18ALP20TOM6SA</b>
<b>Retro reflective</b>				
Operating frequency	20 Hz	20 Hz	20 Hz	20 Hz
Sensing distance (Sn)	3 m, fixed	3 m, fixed	3 m, adjustable	3 m, adjustable
Thyristor (SCR) NC	<b>PA18CLR30TC</b>	<b>PA18CLR30TCM6</b>	<b>PA18ALR30TCSA</b>	<b>PA18ALR30TCM6SA</b>
Thyristor (SCR) NO	<b>PA18CLR30TO</b>	<b>PA18CLR30TOM6</b>	<b>PA18ALR30TOSA</b>	<b>PA18ALR30TOM6SA</b>
<b>Specifications</b>				
Rated operating voltage	20 - 250 VAC	20 - 250 VAC	20 - 250 VAC	20 - 250 VAC
Voltage drop	≤ 10 VAC	≤ 10 VAC	≤ 10 VAC	≤ 10 VAC
Off state current	≤ 5 mA AC	≤ 5 mA AC	≤ 5 mA AC	≤ 5 mA AC
Degree of protection	IP 67	IP 67	IP 67	IP 67
Protection Short-circuit (S)				
Reverse polarity (P)	PT	PT	PT	PT
Transients (T)				
Load current	< 500 mA	< 500 mA	< 500 mA	< 500 mA
Housing material	Polyester (PBTP)	Polyester (PBTP)	Nickel-plated brass	Nickel-plated brass
Operating temperature	-20°C to +60°C	-20°C to +60°C	-20°C to +60°C	-20°C to +60°C
LED colour	Yellow	Yellow	Yellow	Yellow
Approvals/Marks	CE - UL - CSA	CE - UL - CSA	CE - UL - CSA	CE - UL - CSA

# Photoelectric sensors

	Integrated amplifier		Integrated amplifier, transparent	
Types	PD30	PD30	PD30	PD30
Connections	2 m cable	M8 connector	2 m cable	M8 connector
				
Dimensions (mm)	10 x 30 x 20	10 x 30 x 20	10 x 30 x 20	10 x 30 x 20
<b>Retro reflective</b>				
Operating frequency	1000 Hz	1000 Hz	1000 Hz	1000 Hz
Sensing distance (Sn)	6 m, Teach-in	6 m, Teach-in	2 m, Teach-in	2 m, Teach-in
Mute NPN NO/NC	PD30CNR06NPMU	PD30CNR06NPM5MU	PD30CNG02NPMU	PD30CNG02NPM5MU
Mute PNP NO/NC	PD30CNR06PPMU	PD30CNR06PPM5MU	PD30CNG02PPMU	PD30CNG02PPM5MU
Dust NPN NO/NC	PD30CNR06NPDU	PD30CNR06NPM5DU		
Dust PNP NO/NC	PD30CNR06PPDU	PD30CNR06PPM5DU		
Remote NPN NO/NC	PD30CNR06NPRT	PD30CNR06NPM5RT	PD30CNG02NPRT	PD30CNG02NPM5RT
Remote PNP NO/NC	PD30CNR06PPRT	PD30CNR06PPM5RT	PD30CNG02PPRT	PD30CNG02PPM5RT
<b>Retro reflective polariz.</b>				
Operating frequency	1000 Hz	1000 Hz		
Sensing distance (Sn)	6 m, Teach-in	6 m, Teach-in		
Mute NPN NO/NC	PD30CNP06NPMU	PD30CNP06NPM5MU		
Mute PNP NO/NC	PD30CNP06PPMU	PD30CNP06PPM5MU		
Dust NPN NO/NC	PD30CNP06NPDU	PD30CNP06NPM5DU		
Dust PNP NO/NC	PD30CNP06PPDU	PD30CNP06PPM5DU		
Remote NPN NO/NC	PD30CNP06NPRT	PD30CNP06NPM5RT		
Remote PNP NO/NC	PD30CNP06PPRT	PD30CNP06PPM5RT		
<b>Through-beam emitter</b>				
Sensing distance (Sn)	15 m, Teach-in	15 m, Teach-in		
NPN	PD30CNT15NMU	PD30CNT15NM5MU		
PNP	PD30CNT15PMU	PD30CNT15PM5MU		
<b>Through-beam receiver mute function</b>				
Operating frequency	1000 Hz	1000 Hz		
Sensing distance (Sn)	15 m, Teach-in	15 m, Teach-in		
Remote NPN NO/NC	PD30CNT15NPRT	PD30CNT15NPM5RT		
Remote PNP NO/NC	PD30CNT15PPRT	PD30CNT15PPM5RT		
Dust NPN NO/NC	PD30CNT15NPDU	PD30CNT15NPM5DU		
Dust PNP NO/NC	PD30CNT15PPDU	PD30CNT15PPM5DU		
<b>Specifications</b>				
Rated operating voltage	10 - 30 VDC	10 - 30 VDC	10 - 30 VDC	10 - 30 VDC
Voltage drop	≤ 2.4 VDC@100 mA	≤ 2.4 VDC@100 mA	≤ 2.4 VDC@100 mA	≤ 2.4 VDC@100 mA
Degree of protection	IP 67	IP 67	IP 67	IP 67
Protection Short-circuit (S)				
Reverse polarity (P)	SPT	SPT	SPT	SPT
Transients (T)				
Load current	≤ 100 mA	≤ 100 mA	≤ 100 mA	≤ 100 mA
Housing material	ABS	ABS	ABS	ABS
Operating temperature	-25°C to +55°C	-25°C to +55°C	-25°C to +55°C	-25°C to +55°C
LED colour	Yellow + Green	Yellow + Green	Yellow + Green	Yellow + Green
Approvals/Marks	CE - UL508	CE - UL508	CE	CE

# Photoelectric sensors

	Integrated amplifier, diffuse reflective		Laser miniature, DC, integrated amplifier	
Types	PD30	PD30	LD32	LD32
Connections	2 m cable	M8 connector	2 m cable	M8 connector
				
Dimensions (mm)	10 x 30 x 20	10 x 30 x 20	12 x 20 x 32	12 x 20 x 32
<b>Diffuse reflective</b>				
Operating frequency	1000 Hz	1000 Hz	4000 Hz	4000 Hz
Sensing distance (Sn)	1 m, Teach-in	1 m, Teach-in	150 mm, Teach-in	150 mm, Teach-in
NPN NO+NC			<b>LD32CND15NPT</b>	<b>LD32CND15NPM5T</b>
PNP NO+NC			<b>LD32CND15PPT</b>	<b>LD32CND15PPM5T</b>
<b>Dust output</b>				
NPN NO/NC	<b>PD30CND10NPDU</b>	<b>PD30CND10NPM5DU</b>		
PNP NO/NC	<b>PD30CND10PPDU</b>	<b>PD30CND10PPM5DU</b>		
<b>Remote teach</b>				
NPN NO/NC	<b>PD30CND10NPRT</b>	<b>PD30CND10NPM5RT</b>		
PNP NO/NC	<b>PD30CND10PPRT</b>	<b>PD30CND10PPM5RT</b>		
<b>Diffuse reflective background suppress.</b>				
Operating frequency	1000 Hz	1000 Hz	4000 Hz	4000 Hz
Sensing distance (Sn)	150 mm, Teach-in	150 mm, Teach-in	60 mm, Teach-in	60 mm, Teach-in
NPN NO+NC	<b>PD30CNB15NPRT</b>	<b>PD30CNB15NPM5RT</b>	<b>LD32CNB06NPT</b>	<b>LD32CNB06NPM5T</b>
PNP NO+NC	<b>PD30CNB15PPRT</b>	<b>PD30CNB15PPM5RT</b>	<b>LD32CNB06PPT</b>	<b>LD32CNB06PPM5T</b>
<b>Retro reflective polariz.</b>				
Operating frequency			4000 Hz	4000 Hz
Sensing distance (Sn)			1 m, Teach-in	1 m, Teach-in
NPN NO+NC			<b>LD32CNP10NPT</b>	<b>LD32CNP10NPM5T</b>
PNP NO+NC			<b>LD32CNP10PPT</b>	<b>LD32CNP10PPM5T</b>
<b>Specifications</b>				
Rated operating voltage	10 - 30 VDC	10 - 30 VDC	10 - 30 VDC	10 - 30 VDC
Voltage drop	≤ 2.4 VDC@100 mA	≤ 2.4 VDC@100 mA	≤ 2.4 VDC	≤ 2.4 VDC
Degree of protection	IP 67	IP 67	IP 67	IP 67
Protection Short-circuit (S)				
Reverse polarity (P)	SPT	SPT	SPT	SPT
Transients (T)				
Load current	≤ 100 mA	≤ 100 mA	≤ 100 mA	≤ 100 mA
Housing material	ABS	ABS	ABS	ABS
Operating temperature	-25°C to +55°C	-25°C to +55°C	-25°C to +60°C	-25°C to +60°C
LED colour	Yellow + Green	Yellow + Green	Yellow + Green	Yellow + Green
Approvals/Marks	CE - UL508	CE - UL508	CE	CE
Light Source			Laser Class 2	Laser Class 2

# Photoelectric sensors

## Through-beam, transistor output

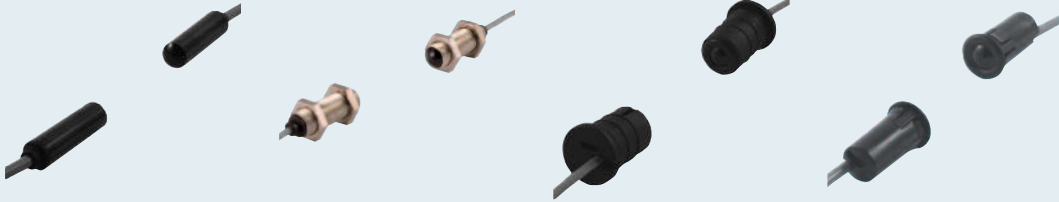
Types	PB10..	PA12	PB18..	PE12..
Connections	5 m cable	M12 connector	5 m cable	5 m cable
				
Dimensions (mm)	Ø10	M12	Ø18	Ø12
<b>Through-beam emitter</b>				
Sensing distance (Sn)	20 m	20 m	15 m	15 m
Single channel	<b>PB10CNT20</b>	<b>PA12BNT20</b>	<b>PB18CNT15</b>	<b>PE12CNT15</b>
Channel 1	<b>PB10C1T20</b>	<b>PA12B1T20</b>		<b>PE12C1T15</b>
Channel 2	<b>PB10C2T20</b>	<b>PA12B2T20</b>		<b>PE12C2T15</b>
Channel 3	<b>PB10C3T20</b>	<b>PA12B3T20</b>		<b>PE12C3T15</b>
<b>Through-beam receiver</b>				
Operating frequency	100 Hz (for 3 ch 30 Hz)	100 Hz (for 3 ch 30 Hz)	100 Hz	100 Hz
Sensing distance (Sn)	25 m	25 m	15 m	15 m
NPN NO Single channel	<b>PB10CNT20NO</b>	<b>PA12BNT20NO</b>	<b>PB18CNT15NO</b>	<b>PE12CNT15NO</b>
NPN NC Single channel	<b>PB10CNT20NC</b>	<b>PA12BNT20NC</b>	<b>PB18CNT15NC</b>	<b>PE12CNT15NC</b>
PNP NO Single channel	<b>PB10CNT20PO</b>	<b>PA12BNT20PO</b>	<b>PB18CNT15PO</b>	<b>PE12CNT15PO</b>
PNP NC Single channel	<b>PB10CNT20PC</b>	<b>PA12BNT20PC</b>	<b>PB18CNT15PC</b>	<b>PE12CNT15PC</b>
NPN NO Channel 1	<b>PB10C1T20NO</b>	<b>PA12B1T20NO</b>		<b>PE12C1T15NO</b>
NPN NC Channel 1	<b>PB10C1T20NC</b>	<b>PA12B1T20NC</b>		<b>PE12C1T15NC</b>
PNP NO Channel 1	<b>PB10C1T20PO</b>	<b>PA12B1T20PO</b>		<b>PE12C1T15PO</b>
PNP NC Channel 1	<b>PB10C1T20PC</b>	<b>PA12B1T20PC</b>		<b>PE12C1T15PC</b>
NPN NO Channel 2	<b>PB10C2T20NO</b>	<b>PA12B2T20NO</b>		<b>PE12C2T15NO</b>
NPN NC Channel 2	<b>PB10C2T20NC</b>	<b>PA12B2T20NC</b>		<b>PE12C2T15NC</b>
PNP NO Channel 2	<b>PB10C2T20PO</b>	<b>PA12B2T20PO</b>		<b>PE12C2T15PO</b>
PNP NC Channel 2	<b>PB10C2T20PC</b>	<b>PA12B2T20PC</b>		<b>PE12C2T15PC</b>
NPN NO Channel 3	<b>PB10C3T20NO</b>	<b>PA12B3T20NO</b>		<b>PE12C3T15NO</b>
NPN NC Channel 3	<b>PB10C3T20NC</b>	<b>PA12B3T20NC</b>		<b>PE12C3T15NC</b>
PNP NO Channel 3	<b>PB10C3T20PO</b>	<b>PA12B3T20PO</b>		<b>PE12C3T15PO</b>
PNP NC Channel 3	<b>PB10C3T20PC</b>	<b>PA12B3T20PC</b>		<b>PE12C3T15PC</b>
<b>Specifications</b>				
Rated operating voltage	10 - 30 VDC	10 - 30 VDC	10 - 30 VDC	10 - 30 VDC
Voltage drop	≤ 1.5 VDC	≤ 1.5 VDC	≤ 1.5 VDC	≤ 1.5 VDC
Degree of protection	IP 67	IP 67	IP 67	IP 67
Protection Short-circuit (S)				
Reverse polarity (P)	SPT	SPT	SPT	SPT
Transients (T)				
Load current	≤ 100 mA	≤ 100 mA	≤ 100 mA	≤ 100 mA
Housing material	PC	PC	PTE	PC
Operating temperature	-20°C to +50°C	-20°C to +50°C	-20°C to +50°C	-20°C to +50°C
LED colour	Green (E), Yellow (R)	Green (E), Yellow (R)		Green (E), Yellow (R)
Approvals/Marks	CE	CE	CE	CE
UL 508	cULus	UL - cUL	cULus	cULus
UL 325	cURus	UR - cURus	cURus	cURus

NB! For pig-tail connector versions add C2 after the part number



# Photoelectric sensors

## DC, integrated amplifier

Types	PD70	PD112	PA.	PB.
Connections	2 m cable or connector		2 m cable or connector	
				
Dimensions (mm)	11.6 x 11.6 x 70	112 x 45 x 25	36 x 18 x 63	18 x 75 x 36

### Diffuse reflective background suppress.

Operating frequency	Door Mode 16.7 Hz Industri mode 250 Hz	1000 Hz	1000 Hz
Sensing distance (Sn)	2.5 m, adjustable	150 mm, adjustable	150 mm, adjustable
Cable	2 m	2 m	2 m
NPN/PNP, NO+NC		PA15INPA/PA15IPPA	PB15INPA/PB15IPPA
NPN+PNP, NO/NC	PD112CNB25BP		
Connector	M12	M12	M12
NPN/PNP, NO+NC		PB15INPA/PB15IPPA	PB15INPA-1/PB15IPPA-1
NPN+PNP, NO/NC	PD112CNB25BPM1		

### Retro reflective polariz.

Operating frequency		1000 Hz	1000 Hz
Sensing distance (Sn)		3 m, adjustable	3 m, adjustable
Cable		2 m	2 m
NPN/PNP, NO+NC		PA3PNPA/PA3PPPA	PB3PNPA/PB3PPPA
Connector		M12	M12
NPN/PNP, NO+NC		PB3PNPA/PB3PPPA	PB3PNPA-1/PB3PPPA-1

### Through-beam



Operating frequency	100 Hz		
Sensing distance (Sn)	12 m, adjustable		
Cable	2 m		
NPN NO (Receiver)	PD70CNT12NO		
NPN NC (Receiver)	PD70CNT12NC		
PNP NO (Receiver)	PD70CNT12PO		
PNP NC (Receiver)	PD70CNT12PC		
Mute High (Emitter)	PD70CNT12MH		
Mute Low (Emitter)	PD70CNT12ML		
Connector	M8		
NPN NO (Receiver)	PD70CNT12NOM5		
NPN NC (Receiver)	PD70CNT12NCM5		
PNP NO (Receiver)	PD70CNT12POM5		
PNP NC (Receiver)	PD70CNT12PCM5		
Mute High (Emitter)	PD70CNT12M5MH		
Mute Low (Emitter)	PD70CNT12M5ML		

### Specifications

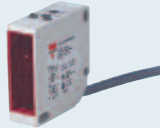

Rated operating voltage	10 - 30 VDC	10 - 30 VDC	10 - 30 VDC	10 - 30 VDC
Voltage drop	≤ 1.8 VDC	≤ 2.5 VDC	≤ 2.5 VDC	≤ 2.5 VDC
Degree of protection	IP 67	IP 67	IP 67	IP 67
Protection Short-circuit (S)				
Reverse polarity (P)	SPT	SPT	SPT	SPT
Transients (T)				
Load current	< 100 mA	< 200 mA	< 200 mA	< 200 mA
Housing material	PC Black	PC Black	Aluminium	Reinforced ABS
Operating temperature	-25°C to +55°C	-25°C to +55°C	-25°C to +60°C	-25°C to +60°C
LED colour	Yellow, Receiver output Green, Emitter power ON	Yellow, Output Green, Power ON	Yellow	Yellow
Approvals/Marks	CE - UR	CE - cULus	CE	CE

# Photoelectric sensors

## Integrated amplifier

Types	PC50	PC50..M1	PC50
Connections	2 m cable	M12 connector	2 m cable
			
Dimensions (mm)	17 x 50 x 50	17 x 50 x 50	17 x 50 x 50
<b>Diffuse reflective</b>			
Operating frequency	500 Hz	500 Hz	20 Hz
Sensing distance (Sn)	1 m, adjustable	1 m, adjustable	
NPN/PNP NO+NC	<b>PC50CND10BA</b>	<b>PC50CND10BAM1</b>	
Sensing distance (Sn)	2 m, adjustable	2 m, adjustable	
NPN/PNP NO+NC	<b>PC50CND20BA</b>	<b>PC50CND20BAM1</b>	
Sensing distance (Sn)			1 m, adjustable
Relay SPDT Multivoltage			<b>PC50CND10RP</b>
Sensing distance (Sn)			2 m, adjustable
Relay SPDT Multivoltage			<b>PC50CND20RP</b>
<b>Diffuse reflective background suppress.</b>			
Operating frequency	250 Hz	250 Hz	
Sensing distance (Sn)	500 mm, adjustable	500 mm, adjustable	
NPN/PNP NO+NC	<b>PC50CNB50BA</b>	<b>PC50CNB50BAM1</b>	
<b>Retro reflective polariz.</b>			
Operating frequency	500 Hz	500 Hz	
Sensing distance (Sn)	6 m, adjustable	6 m, adjustable	
NPN/PNP NO+NC	<b>PC50CNP06BA</b>	<b>PC50CNP06BAM1</b>	
Mute High	<b>PC50CNP06BAMH</b>	<b>PC50CNP06BAM1MH</b>	
Mute Low	<b>PC50CNP06BAML</b>	<b>PC50CNP06BAM1ML</b>	
Relay SPDT Multivoltage			<b>PC50CNP06RP</b>
<b>Retro reflective</b>			
Operating frequency	500 Hz	500 Hz	20 Hz
Sensing distance (Sn)	10 m, adjustable	10 m, adjustable	10 m, adjustable
NPN/PNP NO+NC	<b>PC50CNR10BA</b>	<b>PC50CNR10BAM1</b>	
Relay SPDT Multivoltage			<b>PC50CNR10RP</b>
<b>Through-beam emitter</b>			
Sensing distance (Sn)	20 m	20 m	20 m
	<b>PC50CNT20B</b>	<b>PC50CNT20BM1</b>	<b>PC50CNT20R</b>
<b>Through-beam receiver</b>			
Operating frequency	500 Hz	500 Hz	20 Hz
Sensing distance (Sn)	20 m, adjustable	20 m, adjustable	20 m, adjustable
NPN/PNP NO+NC	<b>PC50CNT20BA</b>	<b>PC50CNT20BAM1</b>	
Relay SPDT Multivoltage			<b>PC50CNT20RP</b>
<b>Specifications</b>			
Rated operating voltage	10 - 30 VDC	10 - 30 VDC	12-240 VDC/24-240 VAC
Voltage drop	≤ 2.5 VDC	≤ 2.5 VDC	Relay SPDT
Degree of protection	IP 67	IP 67	IP 67
Protection Short-circuit (S)			
Reverse polarity (P)	SPT	SPT	PT
Transients (T)			
Load current	≤ 200 mA	≤ 200 mA	≤ 3 A
Housing material	Reinforced ABS/PC	Reinforced ABS/PC	Reinforced ABS/PC
Operating temperature	-20°C to +60°C	-20°C to +60°C	-20°C to +60°C
LED colour	Yellow + Green	Yellow + Green	Yellow + Green
Approvals/Marks	CE - UL - CSA	CE - UL - CSA	CE - UL - CSA



# Photoelectric sensors

	DC, integrated amplifier		Integrated amplifier colour sensors
Types	E.55...	E.55...-1	PD12..
Connections	2 m cable	M12 connector	M12 connector
			
Dimensions (mm)	35 x 55 x 15	35 x 55 x 15	61 x 26 x 125
<b>Diffuse reflective</b>			
Operating frequency	500 Hz (*100 Hz)	500 Hz (*100 Hz)	500 Hz
Sensing distance (Sn)	200 mm, adjustable	200 mm, adjustable	4-50 mm (fiber depend.)
NPN NO+NC	<b>ED5502NPAP</b>	<b>ED5502NPAP-1</b>	
PNP NO+NC	<b>ED5502PPAP</b>	<b>ED5502PPAP-1</b>	
Sensing distance (Sn)	600 mm, adjustable*	600 mm, adjustable*	
NPN NO+NC	<b>ED5506NPAP</b>	<b>ED5506NPAP-1</b>	
PNP NO+NC	<b>ED5506PPAP</b>	<b>ED5506PPAP-1</b>	
NPN/PNP NO+PC			<b>PD12CNC01BPT</b> 1 Output
NPN/PNP NO+PC			<b>PD12CNC04BPT</b> 4 Outputs
<b>Through-beam emitter</b>			
Sensing distance (Sn)	5 m	5 m	
	<b>ET5505</b>	<b>ET5505-1</b>	
<b>Through-beam receiver</b>			
Operating frequency	100 Hz	100 Hz	
Sensing distance (Sn)	5 m, adjustable	5 m, adjustable	
NPN NO + NC	<b>ET5505NPAP</b>	<b>ET5505PPAP</b>	
PNP NO + NC	<b>ET5505NPAP-1</b>	<b>ET5505PPAP-1</b>	
<b>Accessories: fibres</b>			
Dist. 18 mm			<b>FPDC 01 SCC 100</b>
Dist. 40-60 mm			<b>FPDC 02 SCC 100</b>
Dist. 4-6 mm			<b>FPDC 03 SCC 100</b>
Dist. 2-6 mm			<b>FPDC 04 SCC 100</b>
Dist. 4 mm			<b>FPDC 05 SCC 100</b>
<b>General specifications</b>			
Rated operating voltage	10 - 30 VDC	10 - 30 VDC	24 VDC
Voltage drop	≤ 2.5 VDC	≤ 2.5 VDC	≤ 2.2 VDC
Degree of protection	IP67	IP67	IP65
Protection Short-circuit (S)			
Reverse polarity (P)	SPT	SPT	SPT
Transients (T)			
Load current	≤ 200 mA	≤ 200 mA	≤ 100 mA
Housing material	PC / ABS	PC / ABS	PC
Operating temperature	-20°C to +60°C	-20°C to +60°C	0°C to +40°C
LED colour	Yellow	Yellow	Yellow + Green
Approvals/Marks	CE - UL - CSA	CE - UL - CSA	CE - cUL

# Photoelectric sensors



	Integrated amplifier		Fork sensor
Types	PD60..	PD60..M5	PF80..
Connections	2 m cable	M8 connector	M8 connector
			
Dimensions (mm)	13 x 30 x 60	13 x 30 x 60	12 x 37.5 x 80
<b>Transparent detection</b>			
Operating frequency	1000 Hz	1000 Hz	
Sensing distance (Sn)	0.8 m, Teach-in	0.8 m, Teach-in	
NPN/PNP NO+NC	<b>PD60CNG08BPT</b>	<b>PD60CNG08BPM5T</b>	
Sensing distance (Sn)	1.4 m, Teach-in	1.4 m, Teach-in	
NPN/PNP NO+NC	<b>PD60CNG14BPT</b>	<b>PD60CNG14BPM5T</b>	
<b>Fibre optical sensor plastic fibres</b>			
Operating frequency	1000 Hz	1000 Hz	
Sensing distance (Sn)	200 mm	200 mm	
NPN/PNP NO+NC	<b>PD60CNX20BP</b>	<b>PD60CNX20BPM5</b>	
Sensing distance (Sn)	200 mm, Teach-in	200 mm, Teach-in	
NPN/PNP NO+NC	<b>PD60CNX20BPT</b>	<b>PD60CNX20BPM5T</b>	
<b>Fibre optical sensor glass fibres</b>			
Operating frequency	1000 Hz	1000 Hz	
Sensing distance (Sn)	200 mm	200 mm	
NPN/PNP NO+NC	<b>PD60CNV20BP</b>	<b>PD60CNV20BPM5</b>	
Sensing distance (Sn)	200 mm, Teach-in	200 mm, Teach-in	
NPN/PNP NO+NC	<b>PD60CNV20BPT</b>	<b>PD60CNV20BPM5T</b>	
<b>Contrast sensor</b>			
Operating frequency	20 kHz	20 kHz	
Sensing distance (Sn)	18 mm (fibre depend.)	18 mm (fibre depend.)	
NPN/PNP NO+NC	<b>PD60CNK18BPT</b>	<b>PD60CNK18BPM5T</b>	
<b>Fork sensor</b>			
Operating frequency			10 kHz
Sensing distance (Sn)			3 mm, Slot width
NPN/PNP NO+NC			<b>PF80FNT03BPM5T</b>
<b>General specifications</b>			
Rated operating voltage	10 - 30 VDC	10 - 30 VDC	10 - 30 VDC
Voltage drop	≤ 2.0 VDC	≤ 2.0 VDC	≤ 2.0 VDC @ 100 mA ≤ 1.0 VDC @ 10 mA
Degree of protection	IP 65 (IP 67 CNG type)	IP 65 (IP 67 CNG type)	IP65
Protection Short-circuit (S)			
Reverse polarity (P)	SPT	SPT	ST
Transients (T)			
Load current	≤ 100 mA	≤ 100 mA	≤ 40 mA
Housing material	PC	PC	Aluminium, black
Operating temperature	0°C to +60°C	0°C to +60°C	-20°C to +60°C
LED colour	Red	Red	Yellow + Red
Approvals/Marks	CE - UL - cUL	CE - UL - cUL	CE

# Photoelectric sensors





	Integrated amplifier		Through-beam relay output
Types	PM..	PM..	PD98
Connections	Terminals single relay	Terminals mute input	Terminal block
			
Dimensions (mm)	25 x 65 x 81	25 x 65 x 81	98 x 56 x 37
<b>Diffuse reflective</b>			
Oper. freq. / Sens. dist. (Sn)	20 Hz		
Sensing distance (Sn)	0.8 m, adjustable		
Relay SPDT Multivoltage	<b>PMD8RG / RGT</b> <b>PMD8RI / RIT</b>		
<b>Retro reflective polariz.</b>			
Oper. freq. / Sens. dist. (Sn)	20 Hz / 12 m, fixed	20 Hz / 12 m, fixed	
Relay SPDT Multivoltage	<b>PMP12RG / PMP12RI</b>		
Relay SPST		<b>PMP12RGM / PMP12RIM</b>	
<b>Retro reflective</b>			
Oper. freq. / Sens. dist. (Sn)	20 Hz / 10 m, fixed		25 Hz / 30 m, fixed
Relay SPDT Multivoltage	<b>PMR10RG / RGT</b>		
Relay SPST	<b>PMR10RI / RIT</b>		
<b>Through-beam emitter</b>			
Sensing distance (Sn)	20 m	20 m	30 m (15 m default)
	<b>PMT20G / PMT20I</b>	<b>PMT12GM / PMT12IM</b>	<b>PD98CNT30QMU*</b>
<b>Through-beam receiver</b>			
Oper. freq. / Sens. dist. (Sn)	20 Hz / 20 m, fixed	20 Hz / 20 m, fixed	25 Hz / 30 m (15 m default)
Relay SPDT Multivoltage	<b>PMT20RG / RGT</b> <b>PMT20RI / RIT</b>		
Relay SPST		<b>PMT20RGM / PMT20RIM</b>	<b>PD98CNT30QMU*</b>
<b>General specifications</b>			
Rated operating voltage	12 - 240 VDC / 24 - 240 VAC	24 VAC/DC ±20%	12 to 24 VAC/DC
Voltage drop	Relay SPDT	Relay SPST	Relay DPDT
Degree of protection	IP 67	IP 67	54
Protection Short-circuit (S)			
Reverse polarity (P)	PT	PT	PT
Transients (T)			
Load current	≤ 3 A	≤ 3 A	1 A (500 mA)
Housing material	PC/ABS	PC/ABS	PC/ABS
Operating temperature	-25°C to +55°C	-25°C to +55°C	-25°C to +60°C
LED colour	Yellow	Yellow	Yellow (Receiver)
Approvals/Marks	CE - UL - CSA	CE - UL325 - UL508	CE - UL325
Remarks	G = PG 13.5 Outlet I = ½"NPT Outlet T = Timer	G = PG 13.5 Outlet I = ½"NPT Outlet T = Timer	Mute input

\* Item number set, emitter + receiver.

# Photoelectric sensors

	Edge infrared photoelectric safety switch	Heavy duty infrared barrier	Through-beam relay output
<b>Types</b>	<b>IREPSS1</b>	<b>IRPHS20 / IRPHS60</b>	<b>PD180</b>
<b>Connections</b>	<b>Terminal block</b>	<b>Terminal block</b>	<b>Terminal block</b>
			
Dimensions (mm)	34 x 190 x 32	60 x 130 x 52	180 x 51 x 49
<b>Through-beam range</b>			
Indoor sensing distance (max) m	10	20 / 60	15 / 30
<b>General specifications</b>			
Technology	Infrared	Infrared	Infrared
Supply voltage Receiver or Emitter	12/24 VAC/VDC (depending on jumper insertion)	12/24 VAC/VDC (depending on jumper insertion)	12 + 24 VAC/DC
Battery Supply Emitter			2 x 3,6 VDC, 2100 mAH Lithium Batteries size AA
Consumption	60 mA @ 24 VAC (tx + rx)	110 mA @ 24 VAC (tx + rx)	35 mA DC (55 mA DC with low battery alarm).
Output	changeover relay SPDT	NO and NC with double relay in series	2 x SPST
Contact rating	1A@24VAC (resistive load)	1A@24VAC (resistive load)	1A@30VDC (resistive load)
Approvals	CE	CE	CE - UL325
Conformity	EN 12453, EN 954-1, RoHS	EN 12453, EN 954-1, RoHS	EN 12445, EN12453, EN12978, RoHS
Test input			Emitter test input
<b>Environmental specifications</b>			
Wavelength	950 nm	950 nm	850 nm
Operating temperature	-20°C to +60°C	-20°C to +60°C	-25°C to +55°C
Degree of protection	IP 54	IP 66	IP 55
<b>Mechanical specifications</b>			
LED transmitter	Power signal	Power signal	None (energy saving)
LED receiver	Signal for alignment with transmitter	Signal for alignment with transmitter	Power ON - Green LED Output - Yellow LED
Optical adjustment		Horizontal 180°	Horizontal 200° Vertical ±30°
Mounting	Wall or ceiling mounted type	Wall mounted type	Wall mounted type
Weight	310g (couple)	940g (couple)	Emitter 270g Receiver 230g
Comments			Emitter is supplied with 2 x 3.6 VDC 2100 mAH Lithium Batteries

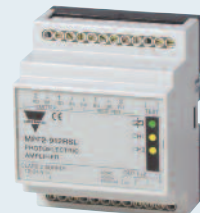
# Photoelectric sensors

	Sensors	Amplifier 1-channel	Amplifier 2-channel	Amplifier 3-channel
<b>Types</b>	<b>MPF..</b>	<b>MPF1..</b>	<b>MPF2..</b>	<b>MPF3..</b>
<b>Connections</b>	<b>10 m cable</b>	<b>Terminals</b>	<b>Terminals</b>	<b>Terminals</b>
				
Dimensions (mm)	See sensor type	70 x 57 x 86	70 x 57 x 86	70 x 57 x 86
<b>Amplifier</b>				
		1-Channel	2-Channel	3-Channel
12-24 VAC/DC ±15% Low current		<b>MPF1-912RSL</b>	<b>MPF2-912RSL</b>	<b>MPF3-912RSL</b>
12-24 VAC/DC ±15%		<b>MPF1-912RS</b>	<b>MPF2-912RS</b>	<b>MPF3-912RS</b>
115 VAC ±15%		<b>MPF1-115RS</b>	<b>MPF2-115RS</b>	<b>MPF3-115RS</b>
230 VAC ±15%		<b>MPF1-230RS</b>	<b>MPF2-230RS</b>	<b>MPF3-230RS</b>
<b>Through-beam emitter</b>		<b>Output and function selection</b>		
Sensing distance (Sn)	15 m	No Dist Adjust		Dist Adjust
Ø12 x 20	<b>MPFT15-4 (C)</b>	Normal Mute	Inverted Mute	Normal Mute Inverted Mute
D11 x 24.5	<b>MPFT11-D11-4 (C)</b>			
D18 x 25	<b>MPFT15-D18-4 (C)</b>	RS	RSI	RSA RSI
M14 x 23	<b>MPFT15-M14-4 (C)</b>	RSL	RSLI	RSLA RSLAI
<b>Through-beam receiver</b>				
Sensing distance (Sn)	15 m			
Ø12 x 20	<b>MPFR-4 (C)</b>			
D11 x 24.5	<b>MPFR-D11-4 (C)</b>			
D18 x 25	<b>MPFR-D18-4 (C)</b>			
M14 x 23	<b>MPFR-M14-4 (C)</b>			
<b>General specifications</b>				
Rated operating voltage	Powered by amplifier	See amplifier reference	See amplifier reference	See amplifier reference
Output		1 x 2 SPST in series	2 x 2 SPST in series	3 x 2 SPST in series
Low current resistive load		RS type: 2 A@240 VAC/30 VDC RSL type: 0.5 A@50 VAC/30 VAC	RS type: 2 A@240 VAC/30 VDC RSL type: 0.5 A@50 VAC/30 VAC	RS type: 2 A@240 VAC/30 VDC RSL type: 0.5 A@50 VAC/30 VAC
Operating frequency	Amplifier dependent	10 Hz	10 Hz	10 Hz
Degree of protection	IP 67	IP 40	IP 40	IP 40
Protection Short-circuit (S) Reverse polarity (P) Transients (T)	SPT	PT	PT	PT
Housing material -Amplifier -Sensor Ø12+D11+D18 -Sensor	PC + ABS PC + Stainless steel	PC	PC	PC
Operating temperature	-20°C to +60°C	-20°C to +60°C	-20°C to +60°C	-20°C to +60°C
LED colour		Yellow	Yellow	Yellow
Approvals/Marks	CE - UL325 - UL508	CE - UL325 - UL508	CE - UL325 - UL508	CE - UL325 - UL508
Remarks	C = Pigtail connector version			
Optical angle (degrees)	±5			

# Photoelectric sensors

## Sensors for amplifiers

Types	MOF..	MOF.. ATEX	MNF..	MDF..
Connections	10 m cable	Terminals	Terminals	Terminals
				
Dimensions (mm)	Ø 10 x 42	Ø 10 x 42	Ø 20 x 80	Ø 13.5 x 55

### Through-beam emitter

Sensing distance (Sn)	20 m	20 m		
Max. ±2° optical angle	<b>MOFT20</b> <b>MOFT20-M12-2</b>	<b>MOFT20AX</b> <b>MOFT20-M12-2AX</b>		
Sensing distance (Sn)	50 m			
Max. ±2° optical angle	<b>MOFT50</b> <b>MOFT50-M12-2</b>			
Sensing distance (Sn)	20 m	20 m		
Max. ±5° optical angle	<b>MOFT20-5</b> <b>MOFT20-M12-5</b>	<b>MOFT20-5AX</b> <b>MOFT20-M12-5AX</b>		
Sensing distance (Sn)	20 m	20 m	15 m	30 m
Max. ±8° optical angle	<b>MOFT20-8</b> <b>MOFT20-M12-8</b> <b>MOFT20-M14-8</b>	<b>MOFT20-8AX</b> <b>MOFT20-M12-8AX</b> <b>MOFT20-M14-8AX</b>	<b>MNFT15</b>	<b>MDFT30</b>

### Through-beam receiver



Operating frequency	Amplifier dependent	Amplifier dependent	Amplifier dependent	Amplifier dependent
Sensing distance (Sn)	See emitter	See emitter	See emitter	See emitter
Max. ±2° optical angle	<b>MOFR</b> <b>MOFR-M12-2</b>	<b>MOFRAX</b> <b>MOFR-M12-2AX</b>		
Max. ±5° optical angle	<b>MOFR-5</b> <b>MOFR-M12-5</b>	<b>MOFR-5AX</b> <b>MOFR-M12-5AX</b>		
Max. ±8° optical angle	<b>MOFR-8</b> <b>MOFR-M12-8</b> <b>MOFR-M14-8</b>	<b>MOFR-8AX</b> <b>MOFR-M12-8AX</b> <b>MOFR-M14-8AX</b>	<b>MNFR15</b>	<b>MDFR30</b>

### General specifications





Rated operating voltage	Powered by Amplifier	Powered by Amplifier	Powered by Amplifier	Powered by Amplifier
Output	On Amplifier	On Amplifier	On Amplifier	On Amplifier
Operating frequency	See Amplifier type: S142.. - S143.. - PAM..	See Amplifier type: S142.. - S143.. - PAM..	See Amplifier type: S142.. - S143.. - PAM..	See Amplifier type: S142.. - S143.. - PAM..
Degree of protection	IP66 - IP67	IP66 - IP67	IP67	IP67
Protection Short-circuit (S) Reverse polarity (P) Transients (T)	SPT	SPT	SPT	SPT
Housing material sensor	Ø10: PC M14 + M14: PC + SS	Ø10: PC M14 + M14: PC + SS	PC M14 + M14: PC + SS	Acetal, glass reinforced
Operating temperature	-20°C to +60°C	-20°C to +60°C	-20°C to +60°C	-20°C to +60°C
LED colour	None	None	None	None
Approvals/Marks	CE	CE - ATEX	CE	CE



# Photoelectric sensors

Types	Amplifiers for sensors		
Connections	11-pole plug	11-pole plug	11-pole plug
			
Dimensions (mm)	35 x 80 x 81.5	35 x 80 x 81.5	35 x 80 x 81.5
Description	Standard amplifier with Sensor diagnostics and adjustable sensing distance	As S142A but with adjustable time delay	As S142A but with Master / Slave function for high neighbour immunity
<b>References amplifier</b>			
1 x SPDT relay	<b>S142ARNN924</b>	<b>S142BRNN924</b>	
1 x NPN Output	<b>S142ARNN024</b>	<b>S142BRNN024</b>	
1 x NPN Alarm Output	<b>S142ARNN115</b> <b>S142ARNN230</b>	<b>S142BRNN115</b> <b>S142BRNN230</b>	
1 x SPDT relay	<b>S142ARNT924</b>	<b>S142BRNT924</b>	
1 x NPN Output or alarm	<b>S142ARNT024</b>		
1 x Emitter mute input	<b>S142ARNT115</b> <b>S142ARNT230</b>	<b>S142BRNT115</b> <b>S142BRNT230</b>	
1 x PNP Output	<b>S142APPT924</b>	<b>S142BPPT924</b>	
1 x PNP Alarm Output	<b>S142APPT115</b>	<b>S142BPPT115</b>	
1 x Emitter mute input	<b>S142APPT230</b>	<b>S142BPPT230</b>	
1 x SPDT relay			<b>S142CRXA924</b>
A - Auto distance adjustment			<b>S142CRXA115</b> <b>S142CRXA230</b>
M - Manual distance adjustment			<b>S142CRXM924</b> <b>S142CRXM115</b> <b>S142CRXM230</b>
<b>General specifications</b>			
Rated operating voltage			
924	24 VAC/DC	24 VAC/DC	24 VAC/DC
115	115 VAC	115 VAC	115 VAC
230	230 VAC	230 VAC	230 VAC
Relay load current resistive load	10 A @ 250 VAC / 25 VDC SPD	10 A @ 250 VAC / 25 VDC SPD	10 A @ 250 VAC / 25 VDC SPD
Transistor Load current	100 mA 40 VDC	100 mA 40 VDC	
Operation frequency	20 Hz	20 Hz, no timer	15 Hz @ 2 systems 4 Hz @ 6 systems
Degree of protection	IP 20	IP 20	IP 20
Protection Short-circuit (S)			
Reverse polarity (P)	SPT	SPT	S
Transients (T)			
Housing material	Noryl SE1, Light grey	Noryl SE1, Light grey	Noryl SE1, Light grey
Operating temperature	-20°C to +50°C	-20°C to +50°C	-20°C to +50°C
Approvals/Marks	CE - UL - CSA	CE - UL - CSA	CE - UL - CSA

# Photoelectric sensors

Types	S1430 UAP..	S1430 RAL..	S1430 ROS..	PAM...
Connections	11-pole plug	11-pole plug	11-pole plug	Terminals
				
Dimensions (mm)	35 x 80 x 81.5	35 x 80 x 81.5	35 x 80 x 81.5	2, 3, 4, 5, 6 DIN housing
Description	3 input 3 transistors outputs	3 input 3 transistors outputs	3 input 3 double relay outputs	2-4-6-8 or 10 channel modular system

## References amplifier

12-30 VAC/DC $\pm 15\%$	<b>S1430UAP912</b>			
15-30 VAC/DC $\pm 10\%$		<b>S1430RAL915</b>	<b>S1430ROS915</b>	
No. of channels				2 channels
- NPN output, NO				<b>PAM02AN3ANO/NC</b>
- PNP output, NO				<b>PAM02AN3APO/PC</b>
No. of channels				4 channels
- NPN output, NO				<b>PAM04AN3ANO/NC</b>
- PNP output, NO				<b>PAM04AN3APO/PC</b>
No. of channels				6 channels
- NPN output, NO				<b>PAM06AN3ANO/NC</b>
- PNP output, NO				<b>PAM06AN3APO/PC</b>



## References extension modules

No. of channels				2 channels
- NPN output, NO				<b>PAM02CN3ANO</b>
- NPN output, NC				<b>PAM02CN3ANC</b>
- PNP output, NO				<b>PAM02CN3APO</b>
- PNP output, NC				<b>PAM02CN3APC</b>
No. of channels				4 channels
- NPN output, NO				<b>PAM04CN3ANO</b>
- NPN output, NC				<b>PAM04CN3ANC</b>
- PNP output, NO				<b>PAM04CN3APO</b>
- PNP output, NC				<b>PAM04CN3APC</b>

## General specifications

Rated operating voltage	See Amplifier type	See Amplifier type	See Amplifier type	18 - 33 VDC
Output	3 x Transistor NPN/PNP/NO/NC	3 x SPST	3 x SPST	One output per channel
Load current resistive load	100 mA, 40 VDC, NPN	1.5 A @ 100 VAC / 30 VDC	1.5 A @ 100 VAC / 30 VDC	20 mA, 33 VDC, NPN / PNP 8 A @ 250VAC / 24 VDC SPDT resistive load
Operation frequency	16 Hz	12.5 Hz	12.5 Hz	30 Hz @ 6 channels
Degree of protection	IP 20	IP 20	IP 20	IP 20
Protection Short-circuit(S) Rev. polarity(P)-Transients(T)	SPT	PT	PT	SPT
Housing material	Noryl SE1, Light grey	Noryl SE1, Light grey	Noryl SE1, Light grey	
Operating temperature	-20°C to +50°C	-20°C to +50°C	-20°C to +50°C	-20°C to +50°C
LED colour	Yellow + Green + Red	Yellow + Green + Red	Yellow + Green + Red	Yellow + Green + Red
Approvals/Marks	Multiplexed system	Multiplexed system	Multiplexed system	Multiplexed system, Test functions, bargraph, mute input etc.

# Photoelectric sensors

Types	Wireless entrapment protection device for industrial doors ESPE		
Connections	Main controller	Subcontroller	PB 11
			
Dimensions (mm)	35 x 35 x 125	26 x 242 x 45	Ø11 x 24.5
Description	The Carlo Gavazzi main controller can control up to 4 subcontrollers	This flexible Carlo Gavazzi subcontroller can handle 2 safety edges and 1 door-in-door limit switch	-
References			
Main controller	<b>WSM 2 B A 2 D24</b>		
Subcontroller	<b>WSS 2 B A 2 BAT</b>		
Photoelectric sensor Emitter			<b>PB 11 CNT 15 WE</b>
Photoelectric sensor Receiver			<b>PB 11 CNT 15 WR</b>
General specifications			
Rated operating voltage	12 - 24 VAC/DC	1 - 4 Lithium 3.6 VDC size AA batteries	From sub controller
Supply current	< 50 mA	-	-
Relay load current resistive load	1A / 30 VDC 0.5 A / 30 VAC	-	-
Communication frequency	2.4 GHz Duplex	2.4 GHz Duplex	-
Response time	120 mS	120 mS	-
Number of channels	16	16	-
Communication distance	10 m wireless	10 m wireless	-
Sensing distance	-	-	15 m
Subcontroller up-time	-	10 - 80 sec	-
Test input	On main module	-	-
Degree of protection	IP 66	IP 66	IP 67
Protection Short-circuit (S) Reverse polarity (P) Transients (T)	PT	P	-
Housing material	ABS, Light grey	PC, Light grey	PA6 Glass reinforced
Operating temperature	-25°C to +55°C	-25°C to +55°C	-25°C to +55°C
LED colour	Green, Yellow, Red	Yellow	-
Approvals/Marks	CE - UL - FCC	CE - UL - FCC	CE - UL

# Photoelectric level sensors

## Integrated amplifier

Types	VP0.E.	VP ATEX	VP E.M
Connections	2 m cable	2 m cable	2 m cable
			
Dimensions (mm)	3/8" x 74 mm	3/8" x 74 mm	3/8" x 74 mm
Light type	Unmodulated	Unmodulated	Unmodulated

## References optical level sensor

Operating frequency	30 Hz	30 Hz	30 Hz
Sensing dist. (Sn), Hor.	± 5 mm, fixed	± 5 mm, fixed	± 5 mm, fixed
Sensing dist. (Sn), Ver.	± 2.5 mm, fixed	± 2.5 mm, fixed	± 2.5 mm, fixed
Housing material	Polysulphone	Polysulphone	Polysulphone
NPN NO	<b>VP02E</b>		<b>VP02EM</b>
NPN NC	<b>VP01E</b>		<b>VP01EM</b>
PNP NO	<b>VP02EP</b>	<b>VP02EPAX</b>	<b>VP02EPM</b>
PNP NC	<b>VP01EP</b>	<b>VP01EPAX</b>	<b>VP01EPM</b>
Housing material	Polyamide 12	Polyamide 12	Polyamide 12
NPN NO	<b>VP04E</b>		<b>VP04EM</b>
NPN NC	<b>VP03E</b>		<b>VP03EM</b>
PNP NO	<b>VP04EP</b>	<b>VP04EPAX</b>	<b>VP04EPM</b>
PNP NC	<b>VP03EP</b>	<b>VP03EPAX</b>	<b>VP03EPM</b>
Housing material	Polysulphone		
SCR NO	<b>VP02-110TB</b>		
SCR NC	<b>VP01-110TB</b>		
SCR NO	<b>VP02-230TB</b>		
SCR NC	<b>VP01-230TB</b>		

## DC-types

Rated operational voltage	10 - 40 VDC	10 - 40 VDC	10 - 40 VDC
Voltage drop	≤ 1.0 VDC	≤ 1.0 VDC	≤ 1.0 VDC
Off-state current	≤ 12 mA	≤ 12 mA	≤ 12 mA
Load current	< 200 mA	< 200 mA	< 200 mA

## AC-types (SCR)

Rated operational voltage	110 or 230 VAC	110 or 230 VAC	110 or 230 VAC
Voltage drop	≤ 9 VAC	≤ 9 VAC	≤ 9 VAC
Off-state current	≤ 7 mA	≤ 7 mA	≤ 7 mA
Load current	< 10 - 100 mA	< 10 - 100 mA	< 10 - 100 mA

## General specifications

Degree of protection	IP 67	IP 67	IP 67
Protection Short-circuit(S) Rev. polarity(P)-Transients(T)	PT	PT	PT
Operating temperature	-20°C to +80°C	-20°C to +80°C	-20°C to +80°C
LED colour	Yellow	Yellow	Yellow
Pressure	10 bar @ +60°C	10 bar @ +60°C	10 bar @ +60°C
Approvals/Marks	CE - UL - CSA	CE - UL - CSA	CE - UL - CSA

# Photoelectric level sensors

## Integrated amplifier

Types	VPA..../VPB....	VPA....-1/VPB....-1
Connections	2 m cable	M12 connector
		
Dimensions	3/8" x 70.5 mm	3/8" x 90.5 mm
Light type	Modulated	Modulated

## References optical level sensor

Operating frequency	30 Hz	30 Hz
Sensing dist. (Sn), Hor.	± 5 mm, fixed	± 5 mm, fixed
Sensing dist. (Sn), Ver.	± 2.5 mm, fixed	± 2.5 mm, fixed
Housing material	Stainless steel/polysulphone	Stainless steel/polysulphone
NPN NO+NC	<b>VPA1MNA</b>	<b>VPA1MNA-1</b>
PNP NO+NC	<b>VPA1MPA</b>	<b>VPA1MPA-1</b>
Housing material	Stainless steel and glass	Stainless steel and glass
NPN NO+NC	<b>VPA2MNA</b>	<b>VPA2MNA-1</b>
PNP NO+NC	<b>VPA2MPA</b>	<b>VPA2MPA-1</b>
Housing material	Nickel-pl. brass/polysulphone	Nickel-pl. brass/polysulphone
NPN NO+NC	<b>VPB1MNA</b>	<b>VPB1MNA-1</b>
PNP NO+NC	<b>VPB1MPA</b>	<b>VPB1MPA-1</b>
Housing material	Nickel-plated brass and glass	Nickel-plated brass and glass
NPN NO+NC	<b>VPB2MNA</b>	<b>VPB2MNA-1</b>
PNP NO+NC	<b>VPB2MPA</b>	<b>VPB2MPA-1</b>

## DC-types

Rated operational voltage	10 - 40 VDC	10 - 40 VDC
Voltage drop	≤ 2.5 VDC	≤ 2.5 VDC
Off-state current	≤ 7 mA	≤ 7 mA
Load current	< 200 mA	< 200 mA

## General specifications

Degree of protection	IP 67	IP 67
Protection Short-circuit(S) Rev. polarity(P)-Transients(T)	SPT	SPT
Operating temperature	-20°C to +80°C	-20°C to +80°C
LED colour	Yellow	No LED
Pressure	10 bar @ +60°C	10 bar @ +60°C
Approvals/Marks	CE - UL - CSA	CE - UL - CSA

# Photoelectric sensors accessories

## Reflectors, rectangular

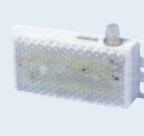
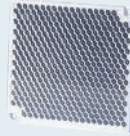
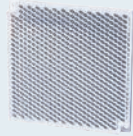

Item Number	<b>ER100</b>	<b>ER840</b>	<b>ER681</b>	<b>ER686</b>
Dimensions (mm)	100 x 100 x 9.2	84.5 x 84.5 x 9	52 x 119 x 27	55.3 x 126 x 9
Mounting (screws not incl.)	2 x M3 screws	2 x M3.5 screws	4 x M4 screws	2 x M6 screws
Reduction factor	1.2	0.96	0.92	0.92

## Reflectors, rectangular

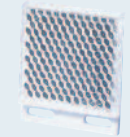
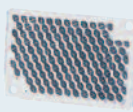

Item Number	<b>ER4060</b>	<b>ER5060</b>	<b>ER42182</b>	<b>ER5080</b>
Dimensions (mm)	60 x 41 x 8	55.5 x 61 x 8	186 x 46.5 x 8	80 x 54 x 8
Mounting (screws not incl.)	2 x M3.5 screws	2 x M4 screws	2 x M6 screws	Adhesive
Reduction factor	0.81	0.80	0.65	0.60

## Reflectors, rectangular



Item Number	<b>ER483</b>	<b>ER8</b>	<b>ER665</b>	<b>ER530</b>
Dimensions (mm)	32.5 x 65 x 8	82 x 37 x 5.5	18.5 x 120 x 65	19 x 72.5 x 8.4
Mounting (screws not incl.)	2 x M3.5 screws	Adhesive	2 x M4 screws	2 x M3.5 screws
Reduction factor	0.55	0.51	0.45	0.45

## Reflectors, rectangular

## Reflectors, cylindrical

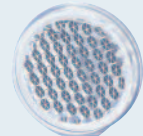

Item Number	<b>ER390</b>	<b>ER1</b>	<b>ER640</b>	<b>ER692</b>
Dimensions (mm)	23.5 x 47.5 x 8	51 x 17.5 x 5	13 x 17 x 5	Ø 35 x 5.5
Mounting (screws not incl.)	2 x M3.5 screws	Adhesive	Adhesive	Adhesive
Reduction factor	1.39	0.20	0.16	0.53

## Reflectors, cylindrical

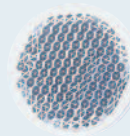
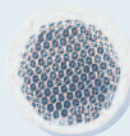
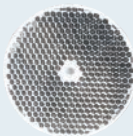

Item Number	<b>ER4</b>	<b>ER460</b>	<b>ER420</b>	<b>ER423</b>
Dimensions (mm)	Ø 84 x 7.4	Ø 46 x 6.5	Ø 42 x 6.3	Ø 41.5 x 6
Mounting (screws not incl.)	1 x M4 screw	Adhesive	Adhesive	2 x M3 screws
Reduction factor	1	0.55	0.54	0.54

# Photoelectric sensors accessories

## Reflectors, cylindrical

## Micro cube reflectors for LD32

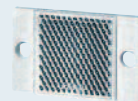
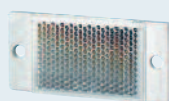
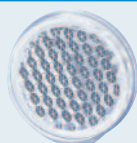

Item Number	<b>ER689</b>	<b>EM 130-20</b>	<b>EM 120-20</b>	<b>EM 123-70</b>
Dimensions (mm)	Ø 25 x 5.5	20 x 43	20 x 32	13.7 x 23
Mounting (screws not incl.)	Adhesive	2 x M3 screws	2 x M3.5 screws	2 x M2 screws
Reduction factor	0.39	1 (Micro Cube)	1 (Micro Cube)	1 (Micro Cube)

## Reflectors, tape

## Micro cube reflectors for LD32

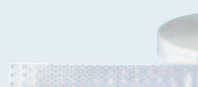

Item Number	<b>ERT25</b>	<b>EM 111-40</b>	<b>EM 121-41</b>	<b>EM 110-40</b>
Dimensions (mm)	25 mm x 45.7 mm	10.5 x 10.5	Ø20	Ø10
Mounting	Adhesive			
Reduction factor	0.23 (25 x 25 mm)	1 (Micro Cube)	1 (Micro Cube)	1 (Micro Cube)

## Reflectors, tape

## Accessories, photoelectric sensors

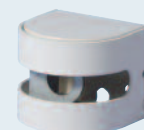

Item Number	<b>ERT50</b>	<b>AMPF-MB1</b>	<b>AMPF-MB2</b>	<b>AMPF-MB3</b>
Dimensions (mm)/Used for	50 mm x 45.7 mm	MPFT15-4 & MPFR-4	MPFT15-4 & MPFR-4	MPFT15-4 & MPFR-4
Mounting (screws not incl.)	Adhesive			
Reduction factor/Description	0.34 (50 x 50 mm)	Plastic mounting bracket for wall mounting.	Adaptor for fitting to an Ø18 mm rubber profile.	Metal mounting bracket for harsh environment.

## Accessories, photoelectric sensors



Item Number	<b>APA18-AK</b>	<b>APA18-RAR</b>	<b>6IODC</b>	<b>APA3</b>
Used for	M18 photoelectrics	M18 photoelectrics	S1430...	PA.. sensors
Description	Ø2, Ø4, and Ø8 mm aperture.	90° mirror for angle detection.	Plug conversion.	Mounting bracket in anodized aluminium.

## Accessories, photoelectric sensors



Item Number	<b>FPD..S.. / FPT..S..</b>	<b>FPD..S.. / FPT..S..</b>	<b>FGD..S.. / FGT..S..</b>	<b>MB-M01</b>
Dimensions (mm)	1 mm fiber	0.25 to 1 mm fiber	1 mm fiber	
Used for	PD60CNX.. EF1810..	PD60CNX.. EF1810..	PD60CNV..	MOF.. sensors
Description	Plastic fibre optics. Separate fibre heads see datasheet.	Plastic fibre optics. Various fibre heads see datasheet.	Glass fibre optics. Various fibre heads see datasheet.	Ball mounting bracket for flexible mounting.

# Photoelectric sensors accessories



## Brackets

				
Item Number	<b>APA2</b>	<b>APB-1</b>	<b>MB02</b>	<b>APD32-MB3</b>
Used for	PA.. sensors	PB	PM	PD32 - LD32
Description	Mounting bracket in steel, black.	Mounting bracket in steel, black.	Long mounting bracket for wall mounting in steel, cromated.	Mounting bracket in steel, cromated.

## Brackets



				
Item Number	<b>APD30 MB1</b>	<b>APD30 MB2</b>	<b>ACP50-1</b>	<b>MB18A</b>
Used for	PD.. sensors	PD.. sensors	PC50.. sensors	M18 sensors
Description	Mounting bracket in steel, chromated.	Mounting bracket in steel, chromated.	Mounting bracket in steel, chromated.	Mounting bracket in plast.

## Brackets



			
Item Number	<b>AMB4-30</b>	<b>APA18-MB1</b>	<b>APH18-MB1</b>
Used for	Ø4 to M30 sensors	PA18 sensors	PH18 sensors
Description	Mounting bracket in plast and steel.	Mounting bracket in plast.	Mounting bracket in plast.



## Wind sensors

	Wind vane	Cup anemometer	Anemometer amplifier
<b>Types</b>	<b>DWS-D-D...</b>	<b>DWS-V-D...</b>	<b>1056G</b>
<b>Connections</b>	<b>2 m cable</b>	<b>2 m cable</b>	<b>2 m cable</b>
			
Dimensions (mm)	207 x 162	137 x 145	230 x 140
Use	Wind direction	Wind speed	Wind security alarm
<b>References wind vane</b>			
Wind indication	0° and 90° intervals		
	<b>DWS-D-DAC13</b>		
Wind indication	±7° and left/right		
	<b>DWS-D-DDC13</b>		
<b>References cup anemometer</b>			
Operating temperature	-20° to 60°C		
Heating	Yes		
	<b>DWS-V-DAC13</b>		
Operating temperature	0° to 60°C		
Heating	No		
	<b>DWS-V-DBC05</b>		
<b>References anemometer amplifier</b>			
Alarm level	At wind speed above 70 km/h		
	<b>1056G</b>		
<b>General specifications</b>			
Rated operating voltage	12 - 24 VDC	12 - 24 VDC	48, 115, 230 or 400 VAC
Voltage drop	Typ. 4.9 VDC	Typ. 4.9 VDC	
Degree of protection	IP 54	IP 54	IP 65
Output frequency	10 Hz pr. m/s	10 Hz pr. m/s	
Housing material	Body: Black PVC Rotor: Stainless steel	Body: Black PVC Rotor: Stainless steel	
Operating temperature	-20°C to +60°C		
LED colour	Yellow + Green		
Approvals/Marks	CE	CE	CE

# Motion sensors

	Standard range RAD series		Long range IRS series
Types	RAD 01	RAD 02	IRS 01
Connections	cable	cable	cable
			
Dimensions (mm)	118 x 80 x 53	118 x 80 x 53	137 x 188 x 91.5
Features	K-Band radar sensor compatible with all swinging and sliding automatic doors. 3-D adjustable position of the sensor offers precise orientation of the activation pattern. Microprocessor technology filters out possible weather condition interferences. IR remote controller can be added for easy adjustment.	K-Band radar sensor compatible with all swinging and sliding automatic doors. 3-D adjustable position of the sensor offers precise orientation of the activation pattern. Microprocessor technology filters out possible weather condition interferences. IR remote controller can be added for easy adjustment.	K-Band unidirectional long range motion sensor for trouble-free opening of all types of industrial automatic doors. To detect either people or vehicles, whether they are moving towards or away from the sensor. Microprocessor technology filters out possible weather condition interferences. IR remote controller can be added for easy adjustment.
<b>Input specifications</b>			
Detection Angle	V: 0 to 90° in 15° increments L: ±30° in 7.5° increments	V: 0 to 90° in 15° increments L: ±30° in 7.5° increments	V: ±45° in 15° increments L: ±45° in 15° increments
Detecting Area	mounting height 2.2m	mounting height 2.2m	mounting height 2.5m~7m
Wide sensing field	4m (W) x 2m (D)	4m (W) x 2m (D)	2.5m (W) x 8m (D)
Narrow sensing field	2m (W) x 2.5m (D)	2m (W) x 2.5m (D)	2.5m (W) x 10m (D)
Detection Mode	Bidirectional	Uni & Bidirectional	Uni & Bidirectional
Motion Detecting Speed	0.05~1m/s	0.05~1m/s	0.05~3.0m/s along sensor axis
<b>Adjustments</b>			
Sensitivity	10 levels (1 to 10)	10 levels (1 to 10)	5 levels (1 to 5)
Hold Time	From 0.5 to 9 s in 10 steps	From 0.5 to 9 s in 10 steps	From 0.5 to 9 s in 10 steps
Immunity Detection	“Quasi-presence”, normal, increased immunity	“Quasi-presence”, normal, increased immunity	“Quasi-presence”, normal, increased immunity, LTS
Direction Recognition	· Bidirectional detection	· Unidirectional approaching · Unidirectional departig · Uni & Bidirectional detection	· Unidirectional approaching · Unidirectional departig · Uni & Bidirectional detection
Operating Modes (or relays assignment)			· Differentiation between people and vehicles · People suppression · Vehicles suppression · People or vehicles with direction segregation
LTS			Lateral traffics suppression “toggle” type function
<b>Output specifications</b>			
Output Relay SPDT			
Max. contact voltage	24VDC / 120VAC	24VDC / 120VAC	24VDC / 120VAC
Max. contact current	1 A (resistive)	1 A (resistive)	1 A (resistive)
Max. switching power	30W (DC) / 120VA (AC)	30W (DC) / 120VA (AC)	30W (DC) / 120VA (AC)
Hold time	0.5~9s (adjustable)	0.5~9s (adjustable)	0.5~6s (adjustable)
<b>Electrical specifications</b>			
Frequency emitted	24.125GHz	24.125GHz	24.125GHz
Rated supply voltage	12~24VAC ±10% 12~24VDC +30% / -10%	12~24VAC ±10% 12~24VDC +30% / -10%	12~24VAC ±10% 12~24VDC +30% / -10%
Mains frequency	50 to 60 Hz	50 to 60 Hz	50 to 60 Hz
Power consumption	< 0.5 W	< 0.5 W	< 1.2 W
Approvals	CE - FCC - cURus	CE - FCC - cURus	CE - FCC - cURus
<b>References</b>			
Sensor	<b>RAD 01</b>	<b>RAD 02</b>	<b>IRS 01</b>
Remote controller	<b>RAD 00 RC</b>	<b>RAD 00 RC</b>	<b>IRS 00 RC</b>

# Motion and presence sensor

Combined motion and presence detector for automatic sliding doors

**Types** **GUARDIAN**

**Connections** **Cable**



Dimensions (mm) 210 x 77 x 58

Technology Digital video camera technology 640 x 480

**Features** The Guardian sensor is a unique motion and presence detector that provides maximum safety and protection in pedestrian sliding door installations. Equipped with the latest digital video camera technology, Guardian watches over the entrance and exit area safeguarding people within, while at the same time controlling the doors. Guardian is able to ignore cross traffic, and it has a brilliant capability of self-adjusting to changes in the environment and weather conditions.

## Input specifications

Mounting height 180 cm to 300 cm

Motion zone sensing area  
 Height 180 cm = 246 x 204 cm  
 Height 220 cm = 300 x 249 cm  
 Height 300 cm = 410 x 340 cm

Presence zone sensing area  
 Height 180 cm = 42 cm x door width  
 Height 220 cm = 51 cm x door width  
 Height 300 cm = 70 cm x door width

Sensitivity Adjusting in 7 steps

Presence time 7 step rotary switch: 1min, 5 min

Ambient Light 10 lux - 50.000 lux

## Output specifications

Output function Safety and Motion Zone: Relay - SPST  
 Common relay data: 1A DC 30VDC  
 600.000 cycles @ 0.5A, 50 VAC/30 VDC

## General specifications

Rated operating voltage 12 - 24 VAC

No load supply current Max. 230 mA

Test input. Active high  
 ON > 9 VAC/VDC  
 OFF < 6 VAC/VDC

Test input. Active low  
 ON < 6 VAC/VDC  
 OFF > 9 VAC/VDC

Type of ESPE Type 2

Environment protection IP 64

TÜV In acc. with machinery directive 2006/42/EC, annex I DIN 18650-1 § 5.7.4, edition 2005 (prEN16005), EN13241-1, EN 12978.

UL-approved cURus: UL325, CSA-C22.2 No. 247

Marking CE

## References

Detector **GUARDIAN 1**

# Light curtains for lift and doors

	Light curtains for lift	Light curtains for doors	
Types	BFL104 - BFL194	BFD40E	BFD40S
			

## Specifications

Diodes number	22 [BFL104] - 40 [BFL194]	40	40
Beams number	104 max [BFL104] - 194 max [BFL194]	40	40
Operating range	0 ÷ 4 m	0 ÷ 12 m	0 ÷ 12 m
Distance between bottom beam and bottom of housing	13.7 mm	13.7 mm	13.7 mm
Protected height	20.5 ÷ 1846 mm	20.5 ÷ 1846 mm [200x] 20.5 ÷ 2528 mm [250x]	20.5 ÷ 1846 mm [200x] 20.5 ÷ 2528 mm [250x]
Light immunity	> 100 Klux	> 100 Klux	> 100 Klux
RX-TX synchronization	By wire	By wire	By wire
Test function		Selectable by connecting a cable	Selectable by connecting a cable

## General specifications



Power supply	10-30 VDC, 18-27 VAC rectified	10-30 VDC	10-30 VDC
Output	NPN, PNP, voltage free NO/NC	NPN, PNP, voltage free NO/NC	NPN, PNP, voltage free NO/NC
Housing material	Plastic (PC-ABS)	Plastic (PC-ABS)	Plastic (PC-ABS)
Degree of protection	IP 54, IP 65	IP 54, IP 65	IP 54, IP 65
Operating temperature	-10° to +55°C, R.H. < 95%	-20° to +55°C, R.H. < 95%	-20° to +55°C, R.H. < 95%
Connecting cable	PVC, 5 x 24 AWG	PVC, 5 x 24 AWG	PVC, 5 x 24 AWG
Dimensions (mm)	30 x 2001 x 9.7 mm	30 x 2001 x 9.7 mm [200x] 30 x 2677 x 9.7 mm [250x]	16.4 x 2000 x 26 mm [200x] 16.4 x 2695 x 26 mm [250x]
Approvals/Marks	CE - UL - CSA	CE - UL - CSA	CE - UL - CSA

## References

<b>BFL104E200</b>	<b>BFD40E200</b>	<b>BFD40S200</b>
<b>BFL104E200I</b>	<b>BFD40E200I</b>	<b>BFD40S200I</b>
<b>BFL194E200</b>	<b>BFD40E250</b>	<b>BFD40S250</b>
<b>BFL194E200I</b>	<b>BFD40E250I</b>	<b>BFD40S250I</b>

# Light curtain accessories

## Light curtain accessories for lift



Types	BFLDIN	BFLBOX
		
Dimensions (mm) DIN RAIL housing On surface by screws	81 x 35.5 x 62.7	Internal: 150 x 105 x 80 External: 165 x 120 x 85 (excluded cable glands)
Function	Power supply unit for lift light curtain	Plastic case including BFLDIN
<b>Output specifications</b>		
11-14	SPST relay (NE or ND)	SPST relay (NE or ND)
Max. load AC1	5A / 250 VAC	5A / 250 VAC
Max. load DC12	5A / 24 VDC	5A / 24 VDC
Electrical life	> 1 x 10 <sup>5</sup> operations	> 1 x 10 <sup>5</sup> operations
Signalling	Buzzer	Buzzer
<b>General specifications</b>		
Power supply	24-48 VAC/DC ±25% [D48] 100-240 VAC/DC ±10% [D23]	24-48 VAC/DC ±25% [D48] 100-240 VAC/DC ±10% [D23]
Degree of protection	IP 20	IP 55
Cable Glands		n. 2 x ø 3.5÷7 mm (for BFL cables Tx & Rx) n.2 x ø 5÷8 mm (for BFLDIN supply and relay output cables)
Approvals/Marks	CE - UL	CE
<b>References</b>		
	<b>BFL DIN D48N</b>	<b>BFL BOX D48N</b>
	<b>BFL DIN D23N</b>	<b>BFL BOX D23N</b>

# Sensors general accessories

## General accessories, sensors

				
Dimensions (mm)	M8 connector	M8 connector	M8 connector	M8 connector
Used for	3-wire DC Sensors	3-wire DC Sensors	3-wire DC Sensors	3-wire DC Sensors
2 m cable	<b>CONM53NF-S2</b>	<b>CONM53NF-A2</b>	<b>CONM54NF-S2</b>	<b>CONM54NF-A2</b>
5 m cable	<b>CONM53NF-S5</b>	<b>CONM53NF-A5</b>	<b>CONM54NF-S5</b>	<b>CONM54NF-A5</b>
10 m cable			<b>CONM54NF-S10</b>	<b>CONM54NF-A10</b>
Description	High-end connector	High-end connector	High-end connector	High-end connector
				
Dimensions (mm)	M12 connector	M12 connector	M12 connector	M12 connector
Used for	2-, 3- or 4-wire DC	2-, 3- or 4-wire DC	2-, 3- or 4-wire DC	2-, 3- or 4-wire DC
2 m cable, 3-pin	<b>CONG10-S2</b>	<b>CONG10-A2</b>	<b>CONM13NF-S2</b>	<b>CONM13NF-A2</b>
5 m cable, 3-pin	<b>CONG10-S5</b>	<b>CONG10-A5</b>	<b>CONM13NF-S5</b>	<b>CONM13NF-A5</b>
10 m cable, 3-pin			<b>CONM13NF-S10</b>	<b>CONM13NF-A10</b>
2 m cable, 4-pin	<b>CONG1A-S2</b>	<b>CONG1A-A2</b>	<b>CONM14NF-S2</b>	<b>CONM14NF-A2</b>
5 m cable, 4-pin	<b>CONG1A-S5</b>	<b>CONG1A-A5</b>	<b>CONM14NF-S5</b>	<b>CONM14NF-A5</b>
10 m cable, 4-pin			<b>CONM14NF-S10</b>	<b>CONM14NF-A10</b>
2 m cable, 5-pin			<b>CONM15NF-S2</b>	<b>CONM15NF-A2</b>
5 m cable, 5-pin			<b>CONM15NF-S5</b>	<b>CONM15NF-A5</b>
10 m cable, 5-pin				<b>CONM15NF-A10</b>
Description	High-end connector	High-end connector	High-end connector	High-end connector
				
Dimensions (mm)	M12 connector	M12 connector	M8 connector	M8 connector
Used for	2-wire AC	2-wire AC	4-wire DC Sensors	4-wire DC Sensors
2 m cable, 3-pin	<b>CONH6A-S2</b>	<b>CONH6A-A2</b>		
5 m cable, 3-pin	<b>CONH6A-S5</b>	<b>CONH6A-A5</b>		
2 m cable			<b>CONG5A-S2</b>	<b>CONG5A-A2</b>
5 m cable			<b>CONG5A-S5</b>	<b>CONG5A-A5</b>
Description	High-end connector	High-end connector	Low-cost connector	Low-cost connector
				
Dimensions (mm)		65 x 27 x 130	M12 connector	M12 connector
Used for	Cylindrical 4 - 30 mm	Stand-alone sensors	2-, 3- or 4-wire DC	2-, 3- or 4-wire DC
Item number	<b>AMB4-30</b>	<b>ST-03</b>		
No cable 4-pin			<b>CONM14NF-S</b>	<b>CONM14NF-A</b>
Description	Universal sensor mounting bracket	Sensor tester for: NAMUR and 2-, 3- or 4-wire DC.	Terminal connection	Terminal connection

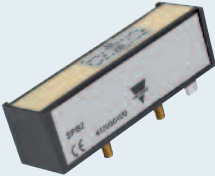
# Proximity magnetic sensors, rectangular

Rectangular			
Types	S series	SPB2 series	SPA1 series
			

Dimensions (mm)	11.5 x 79 x 21.2	25.5 x 85 x 24	16 x 90 x 20
-----------------	------------------	----------------	--------------

## Output functions

Normally open [A] Normally closed [C] Change-over [S] Bistable [B] Bistable CO [BS]	Bistable	Normally closed, 2 outputs
---	----------	-------------------------------

## Electrical specifications

Max. switch. voltage contact	250 VAC [SA/SC 2, SB2/-S5] 1500 VAC [SA/SC 8] 230 VAC [SS2, SBS2]	250 VAC	24 VDC [output 1 and 2]
Max. switch. current contact	1 A [SS2, SBS2] 3 A [SA, SC, SB2]	3 A	0.5 A [output 1] 4 A [output 2]
Max. switch. power contact	100 VA [SA/SC 2, SB2/-S5] 120 VA [SA/SC 8] 60 VA [SS2, SBS2]	100 VA	5 VA [output 1] 100VA [output 2]
Power supply			24 VDC

## General specifications

Operating distance	8 - 32 mm	5 - 30 mm	12 mm
Output connection	PVC cable	Faston [SPB2] Cable [SPB22MT]	PVC cable
Protection degree	IP 67	IP 67 [SPB22MT] IP 65 [SPB2]	IP 67
Operating temperature	-25°C to +75°C	-25°C to +75°C	-25°C to +80°C
Housing material	Plastic	Plastic	ABS class V0

## References

<b>SA2</b>	<b>SPB2</b>	<b>SPA1S2</b>
<b>SA8</b>	<b>SPB22MT</b>	<b>SPA1S3</b>
<b>SC2</b>		
<b>SC8</b>		
<b>SS2</b>		
<b>SB2</b>		
<b>SB2S5</b>		
<b>SBS2</b>		

# Proximity magnetic sensors, rectangular

## Rectangular

### Types

#### M and MS series

#### MM series



Dimensions (mm)

8.3 x 37 x 16

6.1 x 23.5 x 14 [A6]  
7 x 27 x 11 [A3, S1]

### Output functions

Normally open [A]  
Normally closed [C]  
Change-over [S]

Normally open [A]  
Change-over [S]

### Electrical specifications

Max. switch. voltage contact

100 VAC [MS1]  
230 VAC [MSA1]  
500 VAC [MA3, MC3]

100 VAC [S1]  
100 VDC [A6]  
500 VAC [A3]

Max. switch. current contact

0.25 A [MS1]  
0.5 A [MA3, MC3]  
0.75 A [MSA1]

0.25 A [S1]  
0.5 A [A3]  
1 A [A6]

Max. switch. power contact

5 VA [MS1]  
10VA [MSA1, MA2, MC3]

5 VA [S1]  
10 VA [A]

### General specifications

Operating distance

7 - 35 mm

10 - 40 mm

Output connection

PVC cable

PVC cable [A3, S1]  
Twin lead cable [A6]

Protection degree

IP 67

IP 67

Operating temperature

-25°C to +75°C

-25°C to +75°C

Housing material

Plastic

Plastic

### References

**MSA1**

**MMA3**

**MA3**

**MMA6**

**MC3**

**MMS1**

**MS1**



# Proximity magnetic sensors, cylindrical

## Cylindrical

Types	FM... series	FMM... series	FMMP... series
			

Dimensions (mm)	Ø 9.3 [A3, C3, S1] M10 x 0.75 [A3S5, A6] M12 x 1 [C3S1]	M8 x 1	Ø 6 x 25 [L25] Ø 6 x 33 [L33] Ø 6 x 38 [L38]
-----------------	---	--------	--

### Output functions

	Normally open [A] Normally closed [C] Change-over [S]	Normally open [A] Change-over [S]	Normally open
--	---	--------------------------------------	---------------

### Electrical specifications

Max. switch. voltage contact	100 VAC [S1, A6] 500 VAC [A3, C3]	100 VAC [A6, S1] 500 VAC [A3]	100 VAC
Max. switch. current contact	0.25 A [S1] 0.5 A [A3, C3, A6]	0.25 A [S1] 0.5 A [A2, A6]	0.4 A
Max. switch. power contact	5 VA [A3, C3] 100 VA [S1, A6]	5 VA [S1] 10 VA [A3, A6]	12 VA
Max carry current			1 A

### General specifications





Operating distance	5 - 36 mm	8 - 27 mm	> 8 mm
Output connection	PVC cable	PVC cable	Twin lead cable
Protection degree	IP 67	IP 67	IP 67
Operating temperature	-25°C to +75°C	-25°C to +70°C	-20°C to +75°C
Housing material	Plastic [A3, C3, S1] Nickel plated brass [A6] Brass [A3S5, C3S1]	Stainless steel [A3, S1] Nickel plated brass [A6]	Plastic

### References

<b>FMA3</b>	<b>FMMA3</b>	<b>FMMPA7L25</b>
<b>FMA3S5</b>	<b>FMMA6</b>	<b>FMMPA7L33</b>
<b>FMA6</b>	<b>FMMS1</b>	<b>FMMPA7L38</b>
<b>FMC3</b>		
<b>FMC3S1</b>		
<b>FMS1</b>		

# Proximity magnetic sensors, cylindrical

## Cylindrical

Types	FMP... series	FS... series	FSLP... series	FSM... series
				
Dimensions (mm)	M12 x 1	Ø 13.5 [A2, A8, C2, A8, S2] M10 x 1.25 [A2S3, S2S1] M12 x 1 [A2S4, S2S4] M16 x 1.5 [B2]	Ø 16	M12 x 1 [A2, A7, S2] M16 x 1 [S2S2, S2S2AT]

## Output functions

	Normally open [A] Normally closed [C] Change-over [S] Bistable [B]	Normally open [A] Normally closed [C] Change-over [S] Bistable [B]	Normally open [A] Bistable [B]	Normally open [A] Change-over [S]
--	---	---	-----------------------------------	--------------------------------------

## Electrical specifications

Max. switch. voltage contact	100 VAC [S1] 120 VAC [C7] 230 VAC [A9, C9] 250 VAC [B2, A7]	230 VAC [S2S1] 250 VAC [A2, B2, C2] 1500 VAC [A8, C8, S2, S2S4]	100 VAC [A7] 250 VAC [B2]	24 VDC [A7] 230 VAC [S2] 250 VAC [A2]
Max. switch. current contact	0.25 A [S1] 0.5 A [A7, C7] 3 A [B2, A9, C9]	1 A [S2] 3A [A2, B2, C2, A8, C8]	0.4 A [A7] 3 A [B2]	1 A [S2] 3 A [A2] 50 mA [A7]
Max. switch. power contact	5 VA [S1] 10 VA [A7] 20 VA [C7] 60 VA [A9, C9] 120 VA [B2]	60 VA [S2S1] 100 VA [A2, B2, C2] 120 VA [A8, C8, S2, S2S4]	10 VA [A7] 120 VA [B2]	60 VA [S2] 100 VA [A2] (A7 negligible)

## General specifications

Operating distance	7 - 26 mm	3 - 32 mm	18 - 25 mm (front); >10 - >15 mm (side)	2 - 19 mm
Output connection	PVC cable	PVC cable	PVC cable	Silicone cable [A7, S2S2AT] PVC cable [A2, S2, S2S2]
Protection degree	IP 67	IP 67	IP 67	IP 67
Operating temperature	-25°C to +75°C	-25°C to +75°C	-30° to +80°C	-25°C to +75°C -25°C to +180°C [S2S2AT]
Housing material	Plastic	Plastic [A2, A8, C2, C8, S2, B2] Brass [A2S3/S4, S2S1/S4]	Plastic	Brass [S2S2, S2S2AT] Nickel plated brass [A2, A7, S2]

## References

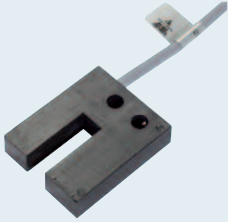
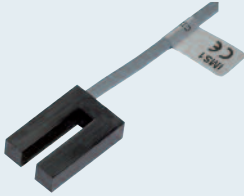

<b>FMPA7</b> [black]	<b>FSA2</b>	<b>FSLPA7</b>	<b>FSMA2</b>
<b>FMPA9</b> [black]	<b>FSA8</b>	<b>FSLPB2</b>	<b>FSMA7</b>
<b>FMPA9S1</b> [black]	<b>FSC2</b>		<b>FSMS2</b>
<b>FMPC7</b> [red]	<b>FSC8</b>		<b>FSMS2S2</b>
<b>FMPC9</b> [red]	<b>FSS2</b>		<b>FSMS2S2AT</b>
<b>FMPS1</b> [blue]	<b>FSA2S32MT</b>		
<b>FMPB2</b> [grey]	<b>FSS2S12MT</b>		
	<b>FSA2S42MT</b>		
	<b>FSS2S42MT</b>		
	<b>FSB22MT</b>		

# Proximity magnetic sensors, slot

Slot			
Types	I. series	ISY. series	IM. series
			
Dimensions (mm)	40 x 75 x 50.7	10 x 45 x 37	7 x 28 x 18.5
<b>Output functions</b>			
	Normally open [A] Normally closed [C] Change-over [S]	Normally closed [C] Change-over [S]	Normally closed [C] Change-over [S]
<b>Electrical specifications</b>			
Max. switch. voltage contact	230 VAC [IS2] 250 VAC [IA2, IC2] 1500 VAC [IA8, IC8]	100 VAC [S1] 500 VAC [C3]	100 VAC [S1] 500 VAC [C3]
Max. switch. current contact	1 A [IS] 3 A [IA, IC]	0.25 A [S1] 0.5 A [C3]	0.25 A [S1] 0.5 A [C3]
Max. switch. power contact	60 VA [IS] 100 VA [IA2, IC2] 120 VA [IA8, IC8]	5 VA [S1] 10 VA [C3]	5 VA [S1] 10 VA [C3]
<b>General specifications</b>			
Output connection	PVC cable	PVC cable	PVC cable
Protection degree	IP 67	IP 67	IP 67
Operating temperature	-25°C to +75°C	-25°C to +75°C	-25°C to +75°C
Housing materials	Plastic	Plastic	Plastic
<b>References</b>			
	<b>IA2</b>	<b>ISYC3</b>	<b>IMC3</b>
	<b>IA8</b>	<b>ISYS1</b>	<b>IMS1</b>
	<b>IC2</b>		
	<b>IC8</b>		
	<b>IS2</b>		

# Level magnetic sensors

## Cylindrical

Types	ILM. ILC series	ILMM. series	ILMP. series
			
Float Diameter (mm)	∅ 53	∅ 28	∅ 25

### Output functions

Normally open,  
normally closed [2, 8]  
Change-over [S2]

Normally open and normally closed  
[5, 590, 5ATS1]  
Normally open [5S2, 5S1, 5S2AT]

Normally open, normally closed

### Electrical specifications

Max. switch. voltage contact	230 VAC [S2] - 250 VAC [2] 1500 VAC [8]	240 VAC, 220 VDC	240 VAC, 200 VDC
Max. switch. current contact	1 A [S2] 3 A [2, 8]	0.5 A	0.5 A
Max. switch. power contact	60 VA [S2] - 100 VA [2] 120 VA [8]	50 VA	50 VA

### General specifications

Output connection	Silicone cable	XLPE cable	PVC cable
Min. liquid specific gravity	0.75 kg/dm <sup>3</sup>	0.75 kg/dm <sup>3</sup>	
Max. pressure	20 kg/cm <sup>2</sup>	10 kg/cm <sup>2</sup>	2 kg/cm <sup>2</sup>
Protection degree	IP 67	IP 67	IP 67
Operating temperature	-25 to +120 °C [2,8] -25 to +80 °C [S2]	-10 to +120°C [5, 590] -10 to +200°C [5ATS1, 5S2AT] -20 to +120°C [5S1, 5S2]	-20°C to +80°C
Housing materials	AISI 316 Stainless steel	AISI 304 stainless steel [5, 590 5ATS1] AISI316 stainless steel [5S2AT, 5S1, 5S2]	Plastic

### References

**ILM2**  
**ILM8**  
**ILMS2**

**ILMM5**  
**ILMM590**  
**ILMM5ATS1**  
**ILMM5S2AT**  
**ILMM5S1**  
**ILMM5S2**

**ILMP5**  
**ILMP5P**

## Types

### Magnetic units CL series

Shapes	Rectangular	Trapezoidal	Cylindrical
			

### General specifications

Minimum separation:	Dimensions (mm)	References				
10	25 x 14 x 8	<b>CL1</b>				
20	44.5 x 12 x 9	<b>CL2</b>				
30	59 x 18 x 9	<b>CL3</b>				
50	76 x 25 x 18	<b>CL4</b>				
Not mandatory			Dimensions (mm)	References	Dimensions (mm)	References
			90 x 31 x 22.5	<b>CL90</b>	∅ 9.3 x 32	<b>CL10</b>
					∅ 13.5 x 65	<b>CL11</b>
					∅ 18 x 6	<b>CL18</b>
					∅ 23 x 9	<b>CL23</b>
					∅ 31 x 10	<b>CL31</b>
					∅ 20 x 10.5	<b>CL20S1</b>
					∅ 22.1 x 20.5	<b>CL20S3</b>
					∅ 50 x 10	<b>CL50</b>

# Level magnetic sensors

## Cylindrical

Types	ILMPU - ILU - ILMU series	ILSP. series	FLM. series - Flux Sensors
			

Float Diameter (mm)	Ø 17.5 [ILMPU] Ø 31 [ILMU] Ø 45 [ILU]	Ø 44	Ø 20
---------------------	---	------	------

### Output functions

	Normally open, normally closed [ILMPU, ILMU] Normally open [ILU] Change-over [ILUS2]	Normally open, normally closed [2, 8] Change-over [S2]	Normally open
--	---	--	---------------

### Electrical specifications

Max. switch. voltage contact	230 VAC [ILUS2] 240 VAC, 200 VDC [ILMP, ILM] 250 VAC [ILU2] 1000 VAC [ILU8]	230 VAC [S2] 250 VAC [2] 1500 VAC [8]	100 VAC
Max. switch. current contact	0.5 A [ILMP, ILM] 1 A [ILUS2] 3 A [ILU2, ILU8]	1 A [S2] 3 A [2, 8]	0.4 A
Max. switch. power contact	50 VA [ILMP, ILM] 60 VA [ILUS2] 100 VA [ILU2] 120 VA [ILU8]	60 VA [S2] 100 VA [2] 120 VA [8]	10 VA

### General specifications



Output connection	Silicone cable	Silicone cable	HT105 PVC cable ended with 6.35 mm female faston
Operating distance $D_{on}$			+5 mm
Release distance $D_{off}$			$D_{on} - 2$ mm
Min. liquid specific gravity	0.70 kg/dm <sup>3</sup> [ILMPU, ILMU] 0.75 kg/dm <sup>3</sup> [ILU]	0.75 kg/dm <sup>3</sup>	
Max. pressure	2 kg/cm <sup>2</sup> [ILMPU, ILMU] 100 kg/cm <sup>2</sup> [ILU]	6 kg/cm <sup>2</sup>	
Protection degree	IP 68	IP 67	IP 67
Operating temperature	-20 to +80°C [ILMPU, ILMU] -25 to +100°C [ILU]	-25 to +100 °C	-30 to +105°C
Housing materials	Non toxic polypropylene or plastic	Plastic	Stainless steel

### References

	<b>ILMPU5</b>	<b>ILSP2</b>	<b>FLMA1S1</b>
	<b>ILMU5</b>	<b>ILSP8</b>	
	<b>ILU2</b>	<b>ILSPS2</b>	
	<b>ILU8</b>		
	<b>ILUS2</b>		

# Environmental sensors

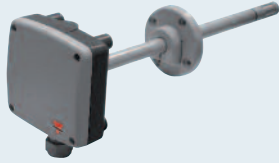
## Environmental sensors - CGES series

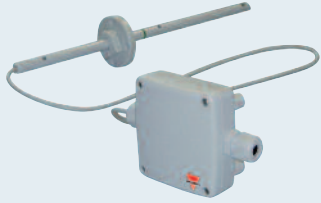
Types	CGESHTD - CGESHTPD	CGESHTW - CGESHTPW	CGESAIRVEL
			
Dimensions (mm)	80 x 80 x 37.2 (probe 200 mm)	85 x 100 x 26	80 x 80 x 37.2 (cable length 1m)
Function	Humidity and Temperature	Humidity and Temperature	Air Velocity measurement
Mounting	Duct mounting	Wall mounting	Wall or Duct mounting
<b>Input specifications</b>			
Relative humidity Working range Accuracy @ 20°C	10 to 95% ±3% RH	0 to 95% ±2% (40 to 60%RH) ±3% (10 to 90%RH)	
Temperature Sensor Accuracy @ 20°C	Pt1000 DIN A ±0.3%°C	Pt1000 DIN A / Pt100 DIN A Vout: ±0.25%°C / Aout: ±0.4°C	
Air Velocity Working range  Accuracy @ 20°C			0 to 10 m/s (0 to 2000 ft/min) 0 to 15 m/s (0 to 3000 ft/min) 0 to 20 m/s (0 to 4000 ft/min) ±0.2 m/s +3% of m.v.
<b>Electrical specifications</b>			
Output	0-10 V or 4-20 mA (2 wires)	0-10 V or 4-20 mA (2 wires)	0-10 V or 4-20 mA
Supply Voltage	24 VAC ±20% / 15-35 VDC	24 VAC ±20% / 15-35 VDC	24 VAC/DC ±20%
Consumption DC supply AC supply	typical 8 mA typical 20 mAeff	typical 4 mA typical 15 mAeff	max. 150 mA max. 90 mA
<b>General specifications</b>			
Cable gland	M16 x 1.5 cable Ø4.5-10 mm		M16 x 1.5 cable Ø4.5-10 mm
Electrical connections	Screw terminals max. 1.5 mm <sup>2</sup> (AWG 16)	Screw terminals max. 1.5 mm <sup>2</sup> (AWG 16)	Screw terminals max. 1.5 mm <sup>2</sup> (AWG 16)
Working temperature range	-5 to 50°C	-5 to 55°C	-10 to 50°C
Storage temperature range	-25 to 60°C	-25 to 60°C	-30 to 60°C
Degree of protection	IP 65; Nema 4	IP 20	IP 65; Nema 4
Conformity	EN 61000-6-1, EN 61000-6-3, EN 61326-1+A1+A2	EN 50081-1 FCC Part15 ClassB EN 50082-1 ICES-003 ClassB	EN 50081-1, EN 50082-1, EN 50082-2
Approvals	CE - RoHS	CE - RoHS	CE - RoHS
<b>References</b>			
For ordering key details, please refer to <a href="http://www.productselection.net">www.productselection.net</a>			



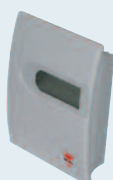
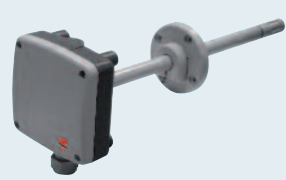

# Environmental sensors

## Environmental sensors - CGES series

Types	CGESCO2VA - CGESCO2TVA - CGESCO2THVA	CGESCO2D
		
Dimensions (mm)	85 x 100 x 26	80 x 80 x 37.2 (probe 200 mm)
Function	CO <sub>2</sub> , Relative Humidity and Temperature	CO <sub>2</sub>
Mounting	Wall mounting	Duct mounting
<b>Input specifications</b>		
Relative humidity		
Working range	10 to 90%	
Accuracy @ 20°C	±3% (30 to 70% RH) ±5% (10 to 90% RH)	
Temperature		
Sensor	Pt1000 DIN A	
Accuracy @ 20°C	Vout: ±0.3%°C / Aout: ±0.7°C	
CO <sub>2</sub>		
Working range	0 to 2000 ppm / 0 to 5000 ppm	0 to 2000 ppm / 0 to 5000 ppm
Accuracy @ 20°C		
2000ppm	< ± 50 ppm +2% of m.v.	< ± 50 ppm +2% of m.v.
5000ppm	< ± 50 ppm +3% of m.v.	< ± 50 ppm +3% of m.v.
<b>Electrical specifications</b>		
Output	0-10 V or 4-20 mA or switching	0-10 V or 4-20 mA or switching
Supply Voltage	24 VAC ±20% / 15-35 VDC	24 VAC ±20% / 15-35 VDC
Consumption		
DC supply	<3 W	< 3W
AC supply	<3 W	< 3W
<b>General specifications</b>		
Cable gland	M16 x 1.5 cable Ø4.5 - 10 mm	
Electrical connections	Screw terminals max. 1.5 mm <sup>2</sup> (AWG 16)	Screw terminals max. 1.5 mm <sup>2</sup> (AWG 16)
Working temperature range	-5 to 55°C	-5 to 55°C
Storage temperature range	-20 to 60°C	-25 to 60°C
Degree of protection	IP 20	IP 65; Nema 4
Conformity	EN 61000-6-3, EN61326-1+A1+A2:05.2002 EN 61000-6-1	EN 61000-6-3 ÖVE EN61326-1+A1+A2:05.2002 EN 61000-6-1, FCC Part 15 ICES-003 ClassB
Approvals	CE - RoHS	CE - RoHS
<b>References</b>		
For ordering key details, please refer to <a href="http://www.productselection.net">www.productselection.net</a>		

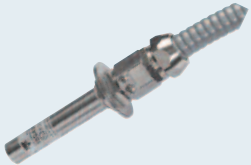
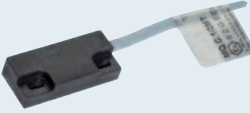
# Intrinsic safety

## Explosion proof sensors

Types	Cylindrical series FSQ	Rectangular series MQ	Level series ILM
			
Exter. Dimensions (mm) Float Dimensions (mm)	Ø16 x 110	37 x 16 x 8.3	Spherical ø 50 [S], Cylindrical ø 45x55 [C]
Category	2G	2G [MQx1EX] 1G [MQx0EX]	2G [ILMx2xEX] 1G [ILMx0xEX]
EX Identification	 II2GExmIIT6	 II2GExmIIT5 [MQx1EX] II1GExiallCT6 [MQx1EX]	 II2GExmIIT5 [ILMx2xEX] II1GExiallCT6 [ILMx2xEX]

## Output functions

	Normally open	Normally open [MQA] Normally closed [MQC] Change-over [MQS]	Normally open [ILMA] Change-over [ILMS]
--	---------------	---	--

## General specifications

Max. switch. voltage contact	230 VAC	230 VAC [MQx1EX] 10.9 V [MQx0EX] 150 VAC [MQS1EX]	230 VAC [ILMx2xEX] 10.9 V [ILMx0xEX]
Max. switch. current contact	3A	0.5 to 3 A [MQx1EX] 15 mA [MQx0EX]	3 A [ILMS2*EX 1A] 15 mA [ILMx0xEX]
Max. switch. power contact	100 VA (FSW 60 VA)	5 to 100 VA [MQx1EX] 41mW [MQx0EX]	100 VA [ILMS2*EX 60 VA] 41 mW [ILMx0xEX]
Effective int. inductance Li	<2 µH (FSW <4 µH)	<3 to <25 µH	<2 µH (ILMS*EX <4 µH)
Effective int. capacitance Ci	<40 pF (FSW <350 pF)	<20 to <300 pF	<40 pF (ILMS*EX <350 pF)
Temperature Class	T6	T5 [MQx1EX] T6 [MQx0EX]	T5 [ILMx2xEX] T6 [ILMx0xEX]
Body material	Stainless steel AISI 303	Self-exting. PP + 30% glass fiber [MQx1EX] PBT (MW series) [MQx0EX]	Stainless steel AISI 316
Approvals/mark	CE - TÜV Nord	CE - TÜV Nord	CE - TÜV Nord

## References

<b>FSQA2B01EX</b>	<b>MQA1EX</b>	<b>ILMA2SEX</b>
	<b>MQC1EX</b>	<b>ILMS2SEX</b>
	<b>MQS1EX</b>	<b>ILMA2CEX</b>
	<b>MQA0EX</b>	<b>ILMS2CEX</b>
	<b>MQS0EX</b>	<b>ILMA0SEX</b>
		<b>ILMS0SEX</b>
		<b>ILMA0CEX</b>
		<b>ILMS0CEX</b>



# Safety magnetic sensors

## Types

## Safety magnetic sensors

### CLS...



## General specifications

Degree of protection	IP 67
Operating temperature	-25° to +70°C
Housing material	Plastic; Stainless Steel (CLSA2M)
Approvals/Marks	CE, cULus listed

## References

External dimensions (mm)	Shape	REFERENCES
88 x 25 x 13	Rectangular	<b>CLS</b>
Ø25.1 x 9.3	Cylindrical	<b>CLSA2; CLSA2M</b>
Ø30 x 16	Cylindrical	<b>CLSA3</b>

### SMS...



## Electrical specifications

Max. switch. voltage	100 VAC
Max. switch. power	5 VA
Max. switch. current	0.25 A

## General specifications

External dimensions (mm)	88 x 25 x 13; M18x1 SMSA2*; M30x1.5 SMSA3P*
Suitable magnetic unit	CLS; CLSA2 (SMSA2P*); CLSA2M (SMSA2M*); CLSA3 (SMSA3P*)
Output connection	Cable (PVC, AWG 26, L=2 m.); pig tail with M12 connector, L=0.3 m
Degree of protection	IP 67
Operating temperature	-25° to +70°C
Housing material	Plastic; PBT + 30 % glass (SMSA2P and SMSA3P); Stainless Steel (SMSA2M)
Approvals/Marks	CE - cULus listed

## References

	Housing type/Material	Safety Aux. Outputs	Aux. Outputs	REFERENCES
	Rectangular/Plastic	1NO	-	<b>SMS10</b>
	Rectangular/Plastic	1NO	1NC	<b>SMS10NC</b>
	Rectangular/Plastic	1NO+1NC	-	<b>SMS01</b>
	Rectangular/Plastic	1NO+1NC	-	<b>SMS02</b>
LED on NC contact	Rectangular/Plastic	1NO+1NC	-	<b>SMS02LD</b>
Resistor on NO contact	Rectangular/Plastic	1NO+1NC	-	<b>SMS02S1</b>
	Rectangular/Plastic	2NO	-	<b>SMS03</b>
0.3 m cable with M12 conn.	Rectangular/Plastic	2NO	-	<b>SMS03CM</b>
	Rectangular/Plastic	2NO	1NC	<b>SMS03NC</b>
0.3 m cable with M12 conn.	Rectangular/Plastic	2NO	1NC	<b>SMS03NCS1</b>
	Cylindrical/Plastic	1NO+1NC	-	<b>SMSA2P02</b>
	Cylindrical/Plastic	1NO	-	<b>SMSA2P10</b>
	Cylindrical/Plastic	2NO	-	<b>SMSA2P30</b>
	Cylindrical/Plastic	1NO+1NC	-	<b>SMSA3P02</b>
	Cylindrical/Plastic	2NO	-	<b>SMSA3P03</b>
	Cylindrical/Plastic	2NO	-	<b>SMSA3P30</b>
	Cylindrical/Metal	1NO+1NC	-	<b>SMSA2M02</b>
	Cylindrical/Metal	1NO	-	<b>SMSA2M10</b>

# Safety light curtains

## Safety light curtains, safety category 2

### Types

### SB2AR series



### General specifications

Power supply	24 VDC $\pm$ 20%
Output functions	2 PNP Output
Output connections	M12 4-pole connector for TX M12 5-pole connector for RX
Safety category	2 (EN954-1)
Performance level	e (EN ISO 13894-1:2008)
Housing material	Painted aluminium
Degree of protection	IP 65
Operating Temperature	0° to +55°C
Approvals/Marks	CE - TÜV - cULus listed

### References

Resolution	Range	Protected height (mm)	No. of beams	Response time (ms)	REFERENCES
Hand mm 30	0.2-19 m	150	8	8	<b>SB2AR 30 150 D19</b>
		300	16	9	<b>SB2AR 30 300 D19</b>
		450	24	11	<b>SB2AR 30 450 D19</b>
		600	32	12	<b>SB2AR 30 600 D19</b>
		750	40	14	<b>SB2AR 30 750 D19</b>
		900	48	15	<b>SB2AR 30 900 D19</b>
		1050	56	17	<b>SB2AR 30 1050 D19</b>
		1200	64	18	<b>SB2AR 30 1200 D19</b>
		1350	72	20	<b>SB2AR 30 1350 D19</b>
		1500	80	21	<b>SB2AR 30 1500 D19</b>
Body mm 90	0.2-19 m	300	5	9	<b>SB2AR 90 300 D19</b>
		450	7	10	<b>SB2AR 90 450 D19</b>
		600	9	11	<b>SB2AR 90 600 D19</b>
		750	11	12	<b>SB2AR 90 750 D19</b>
		900	13	13	<b>SB2AR 90 900 D19</b>
		1050	15	14	<b>SB2AR 90 1050 D19</b>
		1200	17	15	<b>SB2AR 90 1200 D19</b>
		1350	19	16	<b>SB2AR 90 1350 D19</b>
		1500	21	17	<b>SB2AR 90 1500 D19</b>

# Safety light curtains

**Types**                      **Safety light curtains, safety category 2**    **Safety light curtains, safety category 4**

**SB2...**

**SB4...**



## General specifications

Power supply	24 VDC ±20%	24 VDC ±20%
Output functions	2 PNP Output	2 PNP Output
Output connections	M12 4-pole connector for TX M12 8-pole connector for RX	M12 4-pole connector for TX M12 8-pole connector for RX
Auxiliary functions	Total/Partial muting-Override-Auto/manual Reset	Total/Partial muting-Override-Auto/manual Reset
Housing material	Painted aluminium	Painted aluminium
Environment light rejection	IEC-61496-2	IEC-61496-2
Degree of protection	IP 65	IP 65
Operating temperature	-10° to +55°C	-10° to +55°C
Approvals/Marks	CE - TÜV Nord - cULus listed	CE - TÜV Nord - cULus listed

## References

Resolution	Range	Protected height (mm)	No. of beams	Response time (ms)	REFERENCES	Protected height (mm)	No. of beams	Response time (ms)	REFERENCES
Body	0.5-50 m 315-515 mm	515	2	14	<b>SB2 515 515 D50</b>				
		815	3	14	<b>SB2 415 815 D50</b>				
		915	4	14	<b>SB2 315 915 D50</b>				
		1215	4	14	<b>SB2 415 1215 D50</b>				
Body	4-50 m 315-515 mm					515	2	14	<b>SB4 515 515 D50</b>
						815	3	14	<b>SB4 415 815 D50</b>
						915	4	14	<b>SB4 315 915 D50</b>
						1215	4	14	<b>SB4 415 1215 D50</b>
Body	0.5-25 m 315-515 mm					515	2	14	<b>SB4 515 515 D25</b>
						815	3	14	<b>SB4 415 815 D25</b>
						915	4	14	<b>SB4 315 915 D25</b>
						1215	4	14	<b>SB4 415 1215 D25</b>

# Safety light curtains

## Types

## Safety light curtains, safety category 4

### SB4ED

### SB4B

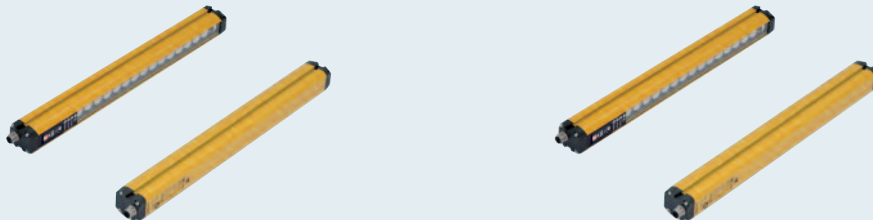

## General specifications

Power supply	24 VDC $\pm$ 20%	24 VDC $\pm$ 20%
Output functions	2 PNP	2 PNP
Other function	EDM	EDM, Fixed/Floating Blanking
Output connections	M12 4-pole connector for TX M12 8-pole connector for RX	M12 4-pole connector for TX M12 8-pole connector for RX
Start/Reset	Auto/Manual selectable	Auto/Manual selectable
Housing material	Painted aluminium	Painted aluminium
Degree of protection	IP 65	IP 65
Operating temperature	0° to +55°C	0° to +55°C
Approvals/Marks	CE - TÜV - cULus listed	CE - TÜV

## References

Resolution	Range	Protected height (mm)	No. of beams	Response time (ms)	REFERENCES	Protected height (mm)	No. of beams	Response time (ms)	REFERENCES
Finger mm	14 0.2-6 m	150	16	11	<b>SB4ED 14 150 D6</b>	161	21	21	<b>SB4B 14 161 D6</b>
		300	32	15	<b>SB4ED 14 300 D6</b>	308	42	28	<b>SB4B 14 308 D6</b>
		450	48	18	<b>SB4ED 14 450 D6</b>	455	63	35	<b>SB4B 14 455 D6</b>
		600	64	22	<b>SB4ED 14 600 D6</b>	602	84	41	<b>SB4B 14 602 D6</b>
		750	80	25	<b>SB4ED 14 750 D6</b>	749	105	48	<b>SB4B 14 749 D6</b>
		900	96	29	<b>SB4ED 14 900 D6</b>	896	126	55	<b>SB4B 14 896 D6</b>
		1050	112	33	<b>SB4ED 14 1050 D6</b>	1043	147	62	<b>SB4B 14 1043 D6</b>
		1200	128	36	<b>SB4ED 14 1200 D6</b>	1190	168	68	<b>SB4B 14 1190 D6</b>
Hand mm	30 0.2-15 m					180	8	16	<b>SB4B 30 180 D15</b>
						327	16	20	<b>SB4B 30 327 D15</b>
						474	24	23	<b>SB4B 30 474 D15</b>
						621	32	25	<b>SB4B 30 621 D15</b>
						768	40	27	<b>SB4B 30 768 D15</b>
						915	48	30	<b>SB4B 30 915 D15</b>
						1062	56	32	<b>SB4B 30 1062 D15</b>
						1209	64	35	<b>SB4B 30 1209 D15</b>
Hand mm	30 0.2-19 m					1356	72	38	<b>SB4B 30 1356 D15</b>
						1503	80	40	<b>SB4B 30 1503 D15</b>
						1650	88	43	<b>SB4B 30 1650 D15</b>
						150	8	9	<b>SB4ED 30 150 D19</b>
						300	16	11	<b>SB4ED 30 300 D19</b>
						450	24	13	<b>SB4ED 30 450 D19</b>
						600	32	14	<b>SB4ED 30 600 D19</b>
						750	40	16	<b>SB4ED 30 750 D19</b>
				900	48	18	<b>SB4ED 30 900 D19</b>		
				1050	56	19	<b>SB4ED 30 1050 D19</b>		
				1200	64	21	<b>SB4ED 30 1200 D19</b>		
				1350	72	23	<b>SB4ED 30 1350 D19</b>		
				1500	80	25	<b>SB4ED 30 1500 D19</b>		
				1650	88	26	<b>SB4ED 30 1650 D19</b>		

# Safety light curtains

## Types

## Safety light curtains, safety category 4

### SB4M & SB4N series



Resolution	Range	Protected height (mm)	No. of beams	Resolution (mm)	REFERENCES Master	REFERENCES Slave
Finger mm 14	0.2-6 m	161	21	21	<b>SB4M 14 161 D6</b>	<b>SB4N 14 161 D6</b>
		308	42	28	<b>SB4M 14 308 D6</b>	<b>SB4N 14 308 D6</b>
		455	63	35	<b>SB4M 14 455 D6</b>	<b>SB4N 14 455 D6</b>
		602	84	41	<b>SB4M 14 602 D6</b>	<b>SB4N 14 602 D6</b>
		749	105	48	<b>SB4M 14 749 D6</b>	<b>SB4N 14 749 D6</b>
		896	126	55	<b>SB4M 14 896 D6</b>	<b>SB4N 14 896 D6</b>
		1043	147	62	<b>SB4M 14 1043 D6</b>	<b>SB4N 14 1043 D6</b>
Hand mm 30	0.2-15 m	1190	168	68	<b>SB4M 14 1190 D6</b>	<b>SB4N 14 1190 D6</b>
		180	8	16	<b>SB4M 30 180 D15</b>	<b>SB4N 30 180 D15</b>
		327	16	20	<b>SB4M 30 327 D15</b>	<b>SB4N 30 327 D15</b>
		474	24	23	<b>SB4M 30 474 D15</b>	<b>SB4N 30 474 D15</b>
		621	32	25	<b>SB4M 30 621 D15</b>	<b>SB4N 30 621 D15</b>
		768	40	27	<b>SB4M 30 768 D15</b>	<b>SB4N 30 768 D15</b>
		915	48	30	<b>SB4M 30 915 D15</b>	<b>SB4N 30 915 D15</b>
		1062	56	32	<b>SB4M 30 1062 D15</b>	<b>SB4N 30 1062 D15</b>
		1209	64	35	<b>SB4M 30 1209 D15</b>	<b>SB4N 30 1209 D15</b>
		1356	72	38	<b>SB4M 30 1356 D15</b>	<b>SB4N 30 1356 D15</b>
		1503	80	40	<b>SB4M 30 1503 D15</b>	<b>SB4N 30 1503 D15</b>
		1650	88	43	<b>SB4M 30 1650 D15</b>	<b>SB4N 30 1650 D15</b>

### General specifications

Power supply	24 VDC $\pm$ 20%
Output functions	2 PNP Output
Other function	EDM, Fixed/Floating Blanking, Cascade
Output connections	M12 4-pole connector for TX / M12 8-pole connector for RX
Master/slave connection	M12 5-pole connector
Start/Reset	Auto/Manual selectable
Housing material	Painted aluminium
Environment light rejection	IEC-61496-2
Degree of protection	IP 65
Operating temperature	-10° to +55°C
Approvals/Marks	CE - TÜV Nord - cULus listed

### SB4T/L/S series

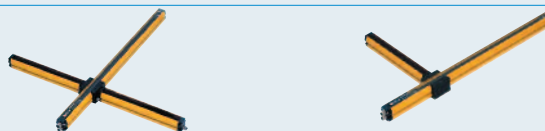

Resp. Time	Range	Protected height (mm)	No. of beams	Resolution (mm)	Muting sensors	REFERENCES
14 ms	0.5-3 m	515	2	515	Integr. bidirectional	<b>SB4T 515 515 D3</b>
		815	3	415	Integr. bidirectional	<b>SB4T 415 815 D3</b>
		515	2	515	Integr. unidirectional	<b>SB4L 515 515 D3</b>
		815	3	415	Integr. unidirectional	<b>SB4L 415 815 D3</b>
14 ms	0.5-25 m	515	2	515	external	<b>SB4S 515 515 D25</b>
		815	3	415	external	<b>SB4S 415 815 D25</b>

### General specifications

Power supply	24 VDC $\pm$ 20%
Output functions	2 PNP
Other function	Muting, EDM
Output connections	M12 4-pole connector for TX / M12 8-pole connector for RX
Start/Reset	Auto/Manual selectable
Housing material	Painted aluminium
Environment light rejection	IEC-61496-2
Degree of protection	IP 65
Operating temperature	-10° to +55°C
Approvals/Marks	CE - TÜV Nord - cULus listed

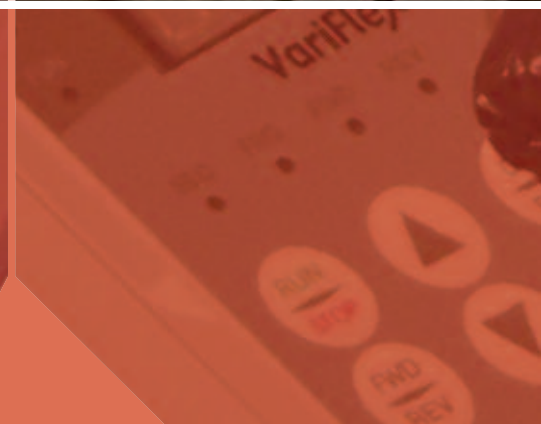
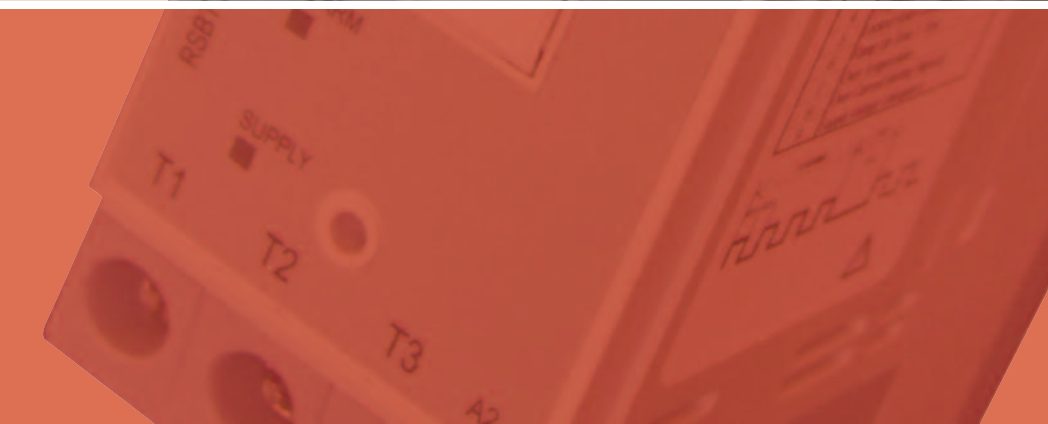



# Switch



Solid state relays	96
Soft starters	115
Solid state relays accessories	120
Variable speed drives	123
Limit switches	127
Pilot lights	135
Push buttons	136
Electromechanical relays	138
Sockets and modules	141

# Solid state relays PCB type, 1-phase

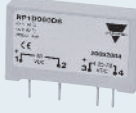

	AC zero switching			DC switching
Types	RP1A - RP1B 3/5/5.5A (AC)	RP..10A 10A (AC)	RAP 3/5A (AC)	RP1D 1A, 4A, 8A (DC)
PCB mounting SSRs, AC and DC operating. Rated isolation voltage $\geq 4000$ Vrms.				
Dimensions H x W x D (mm)	25.4 x 43 x 10.5	37 x 43 x 22	25.4 x 43 x 10.5	25.4 x 43 x 10.5
Features	Standard AC switching SSR	With integral heatsink	LED indication High blocking voltage	DC switching SSR
<b>Input specifications</b>				
Control input range	3-32 VDC [RP1A23..] 3-32 VDC [RP1A40..] 4-32 VDC [RP1A48..] 15-32 VAC [RP1A23A6]	3-32 VDC [RP1A23..] 4-32 VDC [RP1A40..] 4-32 VDC [RP1A48..]	3.5-40 VDC [RAP40..] 4.5-40 VDC [RAP48..]	4.5 - 32 VDC
Max. input current	10 mA	10 mA	12 mA	15 mA
<b>Output specifications</b>				
Rated operational current				DC1: 1/4/8 ADC
AC 51 @ Ta=25°C	3 A [RP1...3] 5 A [RP1...5] 5.5 A [RP1...6]	10 A	3 A [RAP...A3] 5 A [RAP...A5]	
AC 53a @ Ta=25°C	2 A [RP1...3] 3 A [RP1...5] 5 A [RP1...6]	7 A	2.5 A [RAP...A3] 3 A [RAP...A5]	
Min. operational current	20 mA	10 mA	20 mA	1 mADC
Non rep. surge current (t=20 ms)	65 A <sub>p</sub> [RP1...3] 80 A <sub>p</sub> [RP1...5] 250 A <sub>p</sub> [RP1...6]	250 A <sub>p</sub>	60 A <sub>p</sub> [RAP...A3] 90 A <sub>p</sub> [RAP...A5]	
Off-state leakage current	$\leq 1$ mA	$\leq 3$ mA	$\leq 1$ mA	0.01 mADC
I <sub>t</sub> for fusing (t=10 ms)	20 A <sup>2</sup> s [RP1...3] 50 A <sup>2</sup> s [RP1...5] 340 A <sup>2</sup> s [RP1...6]	340 A <sup>2</sup> s	18 A <sup>2</sup> s [RAP...A3] 40 A <sup>2</sup> s [RAP...A5]	
Critical dV/dt off-state	250 V/ $\mu$ s [RP1...3] 500 V/ $\mu$ s [RP1...5] 500 V/ $\mu$ s [RP1...6]	1000 V/ $\mu$ s	100 V/ $\mu$ s	
<b>General specifications</b>				
Operational voltage range	12-265 Vrms [RP1A23..] 20-440 Vrms [RP1A40..] 20-530 Vrms [RP1A48..]	12-265 Vrms [RP1A23..] 20-440 Vrms [RP1A40..] 20-530 Vrms [RP1A48..]	10-440 Vrms [RAP40..] 20-530 Vrms [RAP48..]	1- 60 VDC [RP1D060...] 1 - 350 VDC [RP1D350...]
Blocking voltage	650 V <sub>p</sub> [RP1A23..] 850 V <sub>p</sub> [RP1A40..] 1000 V <sub>p</sub> [RP1A48..]	650 V <sub>p</sub> [RP1A23..] 850 V <sub>p</sub> [RP1A40..] 1000 V <sub>p</sub> [RP1A48..]	1000 V <sub>p</sub> [RAP40..] 1200 V <sub>p</sub> [RAP48..]	
Power factor	0.5	0.5	0.2	0.5
Operating temperature	-20°C to +70°C	-30°C to +80°C	-20°C to +70°C	-20°C to +80°C
Terminals	4 pins x $\varnothing$ 0.1 mm	4 pins x $\varnothing$ 0.1 mm	4 pins x $\varnothing$ 0.1 mm	4 pins x $\varnothing$ 0.1 mm
Approvals/Marks	CE - UL - cUL - VDE	CE - UL - cUL	CE - UL - CSA - VDE	CE - UL - cUL
<b>References</b>				
	3 A	10 A	3 A	1 A
	RP1A23D3	RP1A23D10	RAP40A3	RP1D350D1
	RP1A40D3	RP1A40D10	RAP48A3	
	RP1A48D3	RP1A48D10		4 A
	5 A		5 A	RP1D060D4
	RP1A23D5		RAP40A5	
	RP1A40D5		RAP48A5	8 A
	RP1A48D5			RP1D060D8
	5.5 A			
	RP1A23D6			
	RP1A23A6			
	RP1A40D6			
	RP1A48D6			

\* Other options available on request: Instant-on switching (RP1B..), see Accessories for DIN-rail adaptor.



# Solid state relays, 1-phase

## Industrial Housing, AC Output Switching

Types	RGS1A..D..KKE	RGS1A..A..KKE	RGS1A..MKE
Single phase, chassis mounting industrial relays with LED for control status indication and IP20 protection, AC operating frequency 45-65Hz, Rated isolation voltage $\geq 4000V_{rms}$ , 100kArms Short Circuit Current Rating, Motor ratings according to UL508			
Dimensions (mm)	90 x 17.8 x 50.6	90 x 17.8 x 50.6	90 x 17.8 x 63.6
Features	17.8mm wide solid state relay with thyristor output for AC output switching, integrated varistor for overvoltage protection, DC control voltage range, screw terminals with captivated clamp for connection of power terminals and control terminals, E-type layout configuration	17.8mm wide solid state relay with thyristor output for AC output switching, integrated varistor for overvoltage protection, AC control voltage range covering also a high DC voltage range, screw terminals with captivated clamp for connection of power terminals and control terminals, E-type layout configuration	17.8mm wide solid state relay with thyristor output for AC output switching, integrated varistor for overvoltage protection, DC or AC control voltage range, screw terminals with captivated clamp for connection of power terminals, pluggable spring loaded control terminals, E-type layout configuration

### Input specifications

Control input range	3-32 VDC [RG.23D.] 4-32 VDC [RG.60D.]	20-275 VAC, 24-190 VDC [RG..A.]	3-32 VDC [RG.23D.] / 4-32 VDC [RG.60D.] 20-275 VAC, 24-190 VDC [RG..A.]
Max. input current	11 mADC [RG..D.]	30 mAAC [RG..A.]	11 mADC [RG..D.] / 30 mAAC [RG..A.]

### Output specifications

Rated operational current AC-51 @ Ta=40°C	25 AAC [RGS..25.] / 50 AAC [RGS..50/51.] 75 AAC [RGS..75/71.] / 90 AAC [RGS..90/91.]	25 AAC [RGS..25.] / 50 AAC [RGS..50/51.] 75 AAC [RGS..75/71.] / 90 AAC [RGS..90/91.]	25 AAC [RGS..25.] / 50 AAC [RGS..50.] 75 AAC [RGS..75.] / 90 AAC [RGS..90.]
AC-53a @ Ta=40°C	5 AAC [RGS..25.] / 10 AAC [RGS..50/51.] 14,8 AAC [RGS..75/71.] / 18 AAC [RGS..90/91.]	5 AAC [RGS..25.] / 10 AAC [RGS..50/51.] 14,8 AAC [RGS..75/71.] / 18 AAC [RGS..90/91.]	5 AAC [RGS..25.] / 10 AAC [RGS..50.] 14,8 AAC [RGS..75.] / 18 AAC [RGS..90.]
Min. operational current	150 mA [RGS..25.] / 250 mA [RGS..50/51.] 400 mA [RGS..75/71.] / 400 mA [RGS..90/91.]	150 mA [RGS..25.] / 50 mA [RGS..50/51.] 400 mA [RGS..75/71.] / 400 mA [RGS..90/91.]	150 mA [RGS..25.] / 250 mA [RGS..50.] 400 mA [RGS..75.] / 400 mA [RGS..90.]
Non rep. surge current (t=10 ms)	325 Ap [RGS..25.] 600 Ap [RGS..50/51.] 800 Ap [RGS..75.] 1150 Ap [RGS..71., RGS..90/91.]	325 Ap [RGS..25.] 600 Ap [RGS..50/51.] 800 Ap [RGS..75.] 1150 Ap [RGS..71., RGS..90/91.]	325 Ap [RGS..25.] 600 Ap [RGS..50.] 800 Ap [RGS..75.] 1150 Ap [RGS..90.]
Max. Off-state leak current	3 mAAC	3 mAAC	3 mAAC
I <sup>t</sup> for fusing (t=10 ms)	525 A <sup>2</sup> s [RGS..25.] 1800 A <sup>2</sup> s [RGS..50/51.] 3200 A <sup>2</sup> s [RGS..75.] 6600 A <sup>2</sup> s [RGS..71., RGS..90/91.]	525 A <sup>2</sup> s [RGS..25.] 1800 A <sup>2</sup> s [RGS..50/51.] 3200 A <sup>2</sup> s [RGS..75.] 6600 A <sup>2</sup> s [RGS..71., RGS..90/91.]	525 A <sup>2</sup> s [RGS..25.] 1800 A <sup>2</sup> s [RGS..50.] 3200 A <sup>2</sup> s [RGS..75.] 6600 A <sup>2</sup> s [RGS..90.]
Critical dV/dt off-state	1000 V/μs	1000 V/μs	1000 V/μs

### General specifications

Operational voltage range	24 - 240 VAC +10% [RG.23..] 42 - 600 VAC +10% [RG.60...]	24 - 240 VAC +10% [RG.23..] 42 - 600 VAC +10% [RG.60...]	24 - 240 VAC +10% [RG.23..] 42 - 600 VAC +10% [RG.60...]
Blocking voltage	800 Vp [RGS.23..25/50/75.] 1200 Vp [RGS.60..25/50/75/90.] 1600 Vp [RGS.60..51/71/91.]	800 Vp [RGS.23..25/50/75.] 1200 Vp [RGS.60..25/50/75/90.] 1600 Vp [RGS.60..51/71/91.]	800 Vp [RGS.23..25/50.] 1200 Vp [RGS.60..25/50/75/90.]
Power factor	$\geq 0.5$ at rated voltage	$\geq 0.5$ at rated voltage	$\geq 0.5$ at rated voltage
Operating temperature	-40°C to 80°C	-40°C to 80°C	-40°C to 80°C
Approvals/Marks	CE - cURus - CSA - VDE	CE - cURus - CSA - VDE	CE - cURus - CSA - VDE



### References

230 VAC, 800 Vp	25 AAC: <b>RGS1A23D25KKE</b>	25 AAC: <b>RGC1A23A25KKE</b>	25 AAC: <b>RGS1A23X25MKE</b>
	50 AAC: <b>RGS1A23D50KKE</b>	50 AAC: <b>RGC1A23A50KKE</b>	50 AAC: <b>RGS1A23X50MKE</b>
	75 AAC: <b>RGS1A23D75KKE</b>	75 AAC: <b>RGC1A23A75KKE</b>	
600 VAC, 1200 Vp	25 AAC: <b>RGS1A60D25KKE</b>	25 AAC: <b>RGS1A60A25KKE</b>	25 AAC: <b>RGS1A60X25MKE</b>
	50 AAC: <b>RGS1A60D50KKE</b>	50 AAC: <b>RGS1A60A50KKE</b>	50 AAC: <b>RGS1A60X50MKE</b>
	75 AAC: <b>RGS1A60D75KKE</b>	75 AAC: <b>RGS1A60A75KKE</b>	75 AAC: <b>RGS1A60X75MKE</b>
600 VAC, 1600 Vp	90 AAC: <b>RGS1A60D90KKE</b>	90 AAC: <b>RGS1A60A90KKE</b>	90 AAC: <b>RGS1A60X90MKE</b>
	50 AAC: <b>RGS1A60D51KKE</b>	50 AAC: <b>RGS1A60A51KKE</b>	
	75 AAC: <b>RGS1A60D71KKE</b>	75 AAC: <b>RGS1A60A71KKE</b>	
	90 AAC: <b>RGS1A60D91KKE</b>	90 AAC: <b>RGS1A60A91KKE</b>	

X must be replaced with the following depending on the version required:  
Control voltage (X) D = 3-32VDC, A=20-275VAC, 24-190VDC  
RGS1B.. models for Instant On (Random) Switching is available on request.





CARLO GAVAZZI Automation Components. Specifications are subject to change without notice. Illustrations are for example only.

# Solid state relays, 1-phase

	Industrial Housing AC Output Switching		Industrial Housing DC Output Switching
Types	RGS1A..D..KGU	RGS1A..A..KGU	RGS1D...KKE
Single phase, chassis mounting industrial relays with LED for control status indication and IP20 protection, AC or DC output, Rated isolation voltage $\geq 4000V_{rms}$ , 100kArms Short Circuit Current Rating, Motor ratings according to UL508			
Dimensions HxWxD (mm)	90 x 17.8 x 50.6	90 x 17.8 x 50.6	90 x 17.8 x 50.6
Features	17.8mm wide solid state relay with thyristor output for AC output switching, integrated varistor for overvoltage protection, DC control voltage range, box clamp terminals for connections of power terminals, screw terminals with captivated clamp for connection of control terminals, U-type layout configuration	17.8mm wide solid state relay with thyristor output for AC output switching, integrated varistor for overvoltage protection, AC control voltage range, box clamp terminals for connections of power terminals, screw terminals with captivated clamp for connection of control terminals, U-type layout configuration	17.8mm wide solid state relay with IGBT output for DC output switching, integrated free wheeling diode for output protection, DC control voltage range, screw terminals with captivated clamp for connection of control terminals and power terminals, E-type layout configuration
<b>Input specifications</b>			
Control input range	3-32 VDC [RG.23D.] 4-32 VDC [RG.60D.]	20-275 VAC, 24-190 VDC [RG..A.]	4,5-32 VDC
Max. input current	11 mADC [RG..D.]	30 mAAC [RG..A.]	13,7 mADC
<b>Output specifications</b>			
Rated operational current AC-51 @ Ta=40°C	20 AAC [RGS..20.] 30 AAC [RGS..30.]	20 AAC [RGS..20.] 30 AAC [RGS..30.]	
AC-53a @ Ta=40°C	5 AAC [RGS..20.] 8 AAC [RGS..30.]	5 AAC [RGS..20.] 8 AAC [RGS..30.]	
DC Rated operational current			15 ADC [RGS1D...15.] 25 ADC [RGS1D...25.]
Min. operational current	150 mA [RGS..20.] 250 mA [RGS..30.]	150 mA [RGS..20.] 250 mA [RGS..30.]	20 mA
Non rep. surge current (Itsm) (t=10 ms)	325 Ap [RGS..20.] 600 Ap [RGS..30.]	325 Ap [RGS..20.] 600 Ap [RGS..30.]	200 ADC [10µs]
Max. Off-state leak current	3 mAAC	3 mAAC	1.5 mADC
I <sub>t</sub> for fusing (t=10 ms)	525 A <sup>2</sup> s [RGS..20.] 1800 A <sup>2</sup> s [RGS..30.]	525 A <sup>2</sup> s [RGS..20.] 1800 A <sup>2</sup> s [RGS..30.]	
Critical dV/dt off-state	1000 V/µs	1000 V/µs	
<b>General specifications</b>			
Operational voltage range	24-240 VAC +10% [RG.23.] 42-600 VAC +10% [RG.60.]	24-240 VAC +10% [RG.23.] 42-600 VAC +10% [RG.60.]	24-1000 VDC [CE] 24-600 VDC [UL508]
Blocking voltage	800 Vp [RGS.23.] 1200 Vp [RGS.60.]	800 Vp [RGS.23.] 1200 Vp [RGS.60.]	1200 VDC
Power factor	$\geq 0.5$ at rated voltage	$\geq 0.5$ at rated voltage	
Operating temperature	-40°C to 80°C	-40°C to 80°C	-40°C to 80°C
Approvals/Marks	CE - cURus - CSA - VDE	CE - cURus - CSA - VDE	CE - cURus - CSA
<b>References</b>			
230 VAC, 800 Vp	20 AAC: <b>RGS1A23D20KGU</b> 30 AAC: <b>RGS1A23D30KGU</b>	20 AAC: <b>RGS1A23A20KGU</b> 30 AAC: <b>RGS1A23A30KGU</b>	
600 VAC, 1200 Vp	20 AAC: <b>RGS1A60D20KGU</b> 30 AAC: <b>RGS1A60D30KGU</b>	20 AAC: <b>RGS1A60A20KGU</b> 30 AAC: <b>RGS1A60A30KGU</b>	
1000 VDC			15 ADC: <b>RGS1D1000D15KKE</b> 25 ADC: <b>RGS1D1000D25KKE</b>

RGS1B.. models for Instant On (Random) Switching is available on request.



# Solid state relays, 1-phase

	Industrial housing zero switching		Industrial housing zero / instant-on switching	
Types	<b>RS1A</b> 10/25/40 A	<b>RS1A..A</b> 25/40 A	<b>RAM1A</b> 25/50/75/100/125 A	<b>RM1A</b> 25/50/75/100 A
Single phase, chassis mounting, industrial relays with LED status indication and IP 20 protection. AC operating frequency range 45-65 Hz. Rated isolation voltage $\geq 4000$ Vrms.				
Dimensions HxWxD (mm)	58.2 x 44.8 x 28.8	58.2 x 44.8 x 28.8	58.2 x 44.8 x 28.8	58.2 x 44.8 x 28.8
Features	Ideal for Ohmic loads	AC control Ohmic loads	Built-in snubber, VDE	Built-in Varistor
<b>Input specifications</b>				
Control input range	3-32 VDC [RS1A23D...] 4-32 VDC [RS.....D] 18-36 VAC/DC [RS...LA]	80-130 VAC [RS1A..A1] 200-260 VAC [RS1A..A2] 360-400 VAC [RS1A..A4]	3-32 VDC [RAM1A23D..] 4-32 VDC [RAM1A60D..] 20-280 VAC / 22-48 VDC [RAM..A.]	3-32 VDC [RAM1A23D..] 4-32 VDC [RM1A..D.] 20-280 VAC / 22-48 VDC [RM..A.]
Max. input current	12 mA [RS..D.] 15 mA [RS..LA.]	13 mA	12 mA [RAM1A..D.] 20 mA [RAM1A..A.]	12 mA [RM1A..D.] 20 mA [RM1A..A.]
<b>Output specifications</b>				
Rated operational current				
AC 51 @ Ta=25°C	10/25/40 A	25/40 A	25/50/75/100/125 A	25/50/75/100 A
AC 53a @ Ta=25°C			5/15/17/20/30 A	5/15/20/30 A
Min. operational current	150 mA	150 mA	150 mA	150 mA
Non rep. surge current (t=10 ms)	100 A <sub>p</sub> [RS1A...10] 325 A <sub>p</sub> [RS1A...23] 600 A <sub>p</sub> [RS1A...40]	325 A <sub>p</sub> [RS1A...25] 600 A <sub>p</sub> [RS1A...40]	325 A <sub>p</sub> [RAM1A..25] 600 A <sub>p</sub> [RAM1A..50] 800 A <sub>p</sub> [RAM1A..75] 1150 A <sub>p</sub> [RAM1A..100] 1900 A <sub>p</sub> [RAM1A..125]	325 A <sub>p</sub> [RM1A..25] 600 A <sub>p</sub> [RM1A..50] 1150 A <sub>p</sub> [RM1A..75] 1900 A <sub>p</sub> [RM1A..100]
Off-state leakage current	< 3 mA	< 3 mA	< 3 mA	< 3 mA
I <sup>2</sup> t for fusing (t=10 ms)	$\leq 50$ A <sup>2</sup> s [RS1A..10] $\leq 525$ A <sup>2</sup> s [RS1A..25] $\leq 1800$ A <sup>2</sup> s [RS1A..40]	$\leq 525$ A <sup>2</sup> s [RS1A..25] $\leq 1800$ A <sup>2</sup> s [RS1A..40]	<525 A <sup>2</sup> s [RAM1A..25] <1800 A <sup>2</sup> s [RAM1A..50] <3200 A <sup>2</sup> s [RAM1A..75] <6600 A <sup>2</sup> s [RAM1A..100] <18000 A <sup>2</sup> s [RAM1A..125]	<525 A <sup>2</sup> s [RM1A..25] <1800 A <sup>2</sup> s [RM1A..50] <6600 A <sup>2</sup> s [RM1A..75] <18000 A <sup>2</sup> s [RM1A..100]
Critical dV/dt off-state	500 V/ $\mu$ s	500 V/ $\mu$ s	1000 V/ $\mu$ s	1000 V/ $\mu$ s
<b>General specifications</b>				
Operational voltage range	42-265 Vrms [RS1A23..] 42-440 Vrms [RS1A40..] 42-530 Vrms [RS1A48..]	42-265 Vrms [RS1A23..] 42-440 Vrms [RS1A40..]	24-265 Vrms [RAM1A23..] 42-660 Vrms [RAM1A60..]	24-265 Vrms [RM1A23..] 42-440 Vrms [RM1A40..] 42-530 Vrms [RM1A48..] 42-660 Vrms [RM1A60..]
Blocking voltage	$\geq 650$ V <sub>p</sub> [RS1A23..] $\geq 850$ V <sub>p</sub> [RS1A40..] $\geq 1200$ V <sub>p</sub> [RS1A48..]	$\geq 650$ V <sub>p</sub> [RS1A23..] $\geq 850$ V <sub>p</sub> [RS1A40..]	<650 V <sub>p</sub> [RAM1A23..] <1200 V <sub>p</sub> [RAM1A60..]	<650 V <sub>p</sub> [RM1A23..] <850 V <sub>p</sub> [RM1A40..] <1200 V <sub>p</sub> [RM1A48..] <1400 V <sub>p</sub> [RM1A60..]
Power factor	$\geq 0.95$	$\geq 0.95$	$\geq 0.5$	$\geq 0.5$
Operating temperature	-20°C to +70°C	-30°C to +70°C	-40°C to +80°C	-20°C to +70°C
Terminals	Screw type with clamp	Screw type with clamp	Screw type with clamp	Screw type with clamp
Approvals/Marks	CE - UL - CSA	CE - UL - CSA	CE - UL - CSA - VDE	CE - UL - CSA
<b>References</b>				
	10/25/40 A	25/40 A	25/50/75/100/125 A	25/50/75/100 A
230 Vrms	<b>RS1A23D..</b> <b>RS1A23LA..</b>	<b>RS1A23A1..</b> <b>RS1A23A2..</b> <b>RS1A23A4..</b>	<b>RAM1A23D..</b> <b>RAM1A23A..</b>	<b>RM1A23D..</b> <b>RM1A23A..</b>
400 Vrms	<b>RS1A40D..</b> <b>RS1A40LA..</b>	<b>RS1A40A2..</b> <b>RS1A40A4..</b>		<b>RM1A40D..</b> <b>RM1A40A..</b>
480 Vrms	<b>RS1A48D..</b> <b>RS1A48LA..</b>			<b>RM1A48D..</b> <b>RM1A48A..</b>
600 Vrms			<b>RAM1A60D..</b> <b>RAM1A60A..</b>	<b>RM1A60D..</b> <b>RM1A60A..</b>

\* Other options available on request: Instant-on switching (RAM1B.. RM1B..), see Accessories for Heatsinks.

CARLO GAVAZZI Automation Components. Specifications are subject to change without notice. Illustrations are for example only.



# Solid state relays, 1-phase

	Industrial Housing zero switching	Industrial Housing Peak switching	Industrial Housing Phase angle
Types	RM1A..M 25/50/75/100 A	RM1C 25/50/75/100 A	RM1E 25/50/100 A
Single phase, chassis mounting, industrial relays with LED status indication and IP20 protection AC operating frequency range 45-65 Hz. Rated isolation voltage $\geq 4000$ Vrms.			
Dimensions HxWxD (mm)	58.2 x 44.8 x 28.8	58.2 x 44.8 x 28.8	58.2 x 44.8 x 28.8
Features	Low voltage AC/DC control	Ideal for transformers	Analog Phase-angle control
<b>Input specifications</b>			
Control input range	4.25-36 VDC / 4.25-27 VAC	4.25-32 VDC	4-20 mA [RM1E..AA..] 0-10 VDC [RM1E..V..]
Max. input current	18 mA @ 24 VAC/DC	18 mA	0.15 mA [RM1E..V..]
Supply voltage range			24 VDC [RM1E..V..]
Max. supply input current			20 mA [RM1E..V..]
<b>Output specifications</b>			
Rated operational current			
AC 51 @ Ta=25°C	25/50/75/100 A	25/50/100 A	25/50/100 A
AC 53a @ Ta=25°C	5/15/20/30 A		5/15/20 A
AC 56a @ Ta=25°C		10/20/30 A	
Min. operational current	150 mA	150 mA	150 mA
Non rep. surge current (t=10 ms)	325 A <sub>p</sub> [RM1A..M25] 600 A <sub>p</sub> [RM1A..M50] 1150 A <sub>p</sub> [RM1A..M75] 1900 A <sub>p</sub> [RM1A..M100]	325 A <sub>p</sub> [RM1C..25] 600 A <sub>p</sub> [RM1C..50] 1150 A <sub>p</sub> [RM1C..75] 1900 A <sub>p</sub> [RM1C..100]	325 A <sub>p</sub> [RM1E..25] 600 A <sub>p</sub> [RM1E..50] 1150 A <sub>p</sub> [RM1E..100]
Off-state leakage current	< 3 mA	< 3 mA	< 3 mA
I <sub>t</sub> for fusing (t=10 ms)	$\leq 525$ A <sup>2</sup> s [RM1A..M25] $\leq 1800$ A <sup>2</sup> s [RM1A..M50] $\leq 6600$ A <sup>2</sup> s [RM1A..M75] $\leq 18000$ A <sup>2</sup> s [RM1A..M100]	$\leq 525$ A <sup>2</sup> s [RM1C..25] $\leq 1800$ A <sup>2</sup> s [RM1C..50] $\leq 6600$ A <sup>2</sup> s [RM1C..75] $\leq 18000$ A <sup>2</sup> s [RM1C..100]	$\leq 525$ A <sup>2</sup> s [RM1E..25] $\leq 1800$ A <sup>2</sup> s [RM1E..50] $\leq 6600$ A <sup>2</sup> s [RM1E..100]
<b>General specifications</b>			
Operational voltage range	24-265 Vrms [RM1A23M.] 42-440 Vrms [RM1A40M.] 42-530 Vrms [RM1A48M.] 42-660 Vrms [RM1A60M.]	100-440 Vrms [RM1C40D.] 340-660 Vrms [RM1C60D.]	90-280/ 90-265 Vrms [RM1E23AAV..] 340-460 Vrms [RM1E40AA..] 90-550/ 200-550 Vrms [RM1E48AAV..] 410-660 Vrms [RM1E60AAV..]
Blocking voltage	$\geq 650$ V <sub>p</sub> [RM1A23M.] $\geq 850$ V <sub>p</sub> [RM1A40M.] $\geq 1200$ V <sub>p</sub> [RM1A48M.] $\geq 1400$ V <sub>p</sub> [RM1A60M.]	850 V <sub>p</sub> [RM1C40D..] 1400 V <sub>p</sub> [RM1C60D..]	<650 V <sub>p</sub> [RM1E23..] <850 V <sub>p</sub> [RM1E40..] <1200 V <sub>p</sub> [RM1E48..] <1400 V <sub>p</sub> [RM1E60..]
Power factor	$\geq 0.5$	$\geq 0.95$	$\geq 0.75$
Operating temperature	-20°C to +70°C	-30°C to +80°C	-20°C to +70°C
Terminals	Screw type with clamp	Screw type with clamp	Screw type with clamp
Approvals/Marks	CE - UL - CSA	CE - UL - CSA	CE - UL - CSA
<b>References 1-phase:</b>			
	25/50/75/100 A	25/50/75/100 A	25/50/100 A
230 Vrms	RM1A23M..		RM1E23AA25** RM1E23AA50** RM1E23AA100**
400 Vrms	RM1A40M..	RM1C40D25 RM1C40D50 RM1C40D75	RM1E40AA25 RM1E40AA50 RM1E40AA100
480 Vrms	RM1A48M..		RM1E48AA25** RM1E48AA50** RM1E48AA100**
600 Vrms	RM1A60M..	RM1C60D25 RM1C60D50 RM1C60D100	RM1E60AA25** RM1E60AA50** RM1E60AA100**

\*\* Replace "AA" by "V" for voltage controlled versions



# Solid state relays, 1 / 2-phase

## AC Switching

Types	<b>RA Sense</b> 25/50/90/110 A	<b>RA Low Noise</b> 10/25 A	<b>RA 2-pole*</b> 25/40 A
Single Phase relays with special functions. 2-Phase industrial relays.			
Dimensions HxWxD (mm)	58.2 x 44.8 x 28.8	58.2 x 44.8 x 28.8	58.2 x 44.8 x 28.8
Features	Detects supply and load failure	Complies with EN55022	Two independent poles
<b>Input specifications</b>			
Control input range	7-32 VDC	3-32 VDC	4.5-32 VDC
Max. input current	4 mA	32 mA	2 x 10 mA
Control supply	20-32 VDC ("40 mA)		
Alarm output	PNP NPN	VCC - 2 VDC ("100mA) 2 VDC ("100mA)	
<b>Output specifications</b>			
Rated operational current			
AC 51 @ Ta=25°C	25 A / 50 A / 90 A / 110 A	10 A / 25 A	25 A / 40 A per pole
AC 53a @ Ta=25°C			5 A / 15 A per pole
Min. operational current	200 mArms	2 Arms	150 mArms
Non rep. surge current (t=10 ms)	325 A <sub>p</sub> [RA..25..S] 600 A <sub>p</sub> [RA..50..S] 1150 A <sub>p</sub> [RA..90..S] 1900 A <sub>p</sub> [RA..110..S]	90 A <sub>p</sub> , t=20 ms [RA..10..L] 200 A <sub>p</sub> , t=20 ms [RA..25..L]	325 A <sub>p</sub> [RA2A..25] 600 A <sub>p</sub> [RA2A..40] 325 A <sub>p</sub> [RA2A..25M] 600 A <sub>p</sub> [RA2A..40M]
Off-state leakage current	< 6 mArms	< 1 mArms	< 3 mArms
I <sup>2</sup> t for fusing (t=10 ms)	525 A <sup>2</sup> s [RA..25..S] 1800A <sup>2</sup> s [RA..50..S] 6600 A <sup>2</sup> s [RA..90..S] 18000 A <sup>2</sup> s [RA..110..S]	120 A <sup>2</sup> s [RA..10..L] 200A <sup>2</sup> s [RA..25..L]	525 A <sup>2</sup> s [RA2A..25] 1800 A <sup>2</sup> s [RA2A..40] 525 A <sup>2</sup> s [RA2A..25M] 1800A <sup>2</sup> s [RA2A..40M]
<b>General specifications</b>			
Operational voltage range	60-140 Vrms [RA12..S] 170-250 Vrms [RA23..S] 150-440 Vrms [RA40..S] 180-530 Vrms [RA48..S]	180-265 Vrms [RA24..L] 340-530 Vrms [RA40..L]	24-265 Vrms [RA2A23..] 42-440 Vrms [RA2A40..] 42-530 Vrms [RA2A48..] 42-660 Vrms [RA2A60..]
Blocking voltage	650 V <sub>p</sub> [RA12..S] 650 V <sub>p</sub> [RA23..S] 1000 V <sub>p</sub> [RA40..S] 1200 V <sub>p</sub> [RA48..S]	650 V <sub>p</sub> [RA24..L] 850 V <sub>p</sub> [RA40..L]	650 V <sub>p</sub> [RA2A23..] 850 V <sub>p</sub> [RA2A40..] 1200 V <sub>p</sub> [RA2A48..] 1200 V <sub>p</sub> [RA2A60..]
Power factor	≥ 0.5	1	≥0.95 [RA24...] ≥0.50 [RA24...M]
Operating temperature	-20°C to +70°C	-20°C to +70°C	-20°C to +70°C
Terminals	Screw / 5 way plug	Screw type with clamp	FASTONS 6.3 mm
Approvals/Marks	CE - UL - CSA	CE - UL - CSA - VDE	CE - UL - CSA
<b>References</b>			
	25/50/90/110 A	10/25 A	25/40 A per pole
120 Vrms	<b>RA12..06..S</b>		
230 Vrms	<b>RA23..06..S</b>	<b>RA2410-D06L</b> <b>RA2425-D06L</b>	<b>RA2A23..</b> <b>RA2A23..M</b>
400 Vrms	<b>RA40..10..S</b>	<b>RA4010-D08L</b> <b>RA4025-D08L</b>	<b>RA2A40..</b> <b>RA2A40..M</b>
480 Vrms	<b>RA48..12..S</b>		<b>RA2A48..</b> <b>RA2A48..M</b>
600 Vrms			<b>RA2A60..</b> <b>RA2A60..M</b>

\* RA 2-pole: for inductive loads use types with suffix "M".

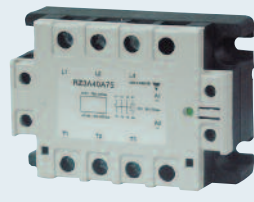

# Solid state relays, 1 / 3-phase

	Industrial Housing Zero switching	Industrial Housing DC switching	Industrial Housing 3-Phase switching
<b>Types</b>	<b>RA</b> 25/50/90/110 A	<b>RD</b> 1/5 A DC	<b>RZ3A</b> 25/55/75 A
Single phase and 3 phase industrial relays.			
Dimensions HxWxD (mm)	58.2 x 44.8 x 28.8	58.2 x 44.8 x 28.8	74 x 103 x 41
Features	General purpose	Ideal for DC valve coils	3-phase switching
<b>Input specifications</b>			
Control input range	3-32 VDC [RA..D..] 10-90 VAC/DC [RA..LA..] 90-280 VAC/DC [RA..HA..]	3-32 VDC	4-32 VDC [RZ3A..D..] 24-275 Vrms [RZ3A..A..]
Max. input current	22 mA [RA..D..] 17 mA [RA..LA..] 6.5 mA [RA..HA..]	32 mA	23 / 15 mA
<b>Output specifications</b>			
Rated operational current			
AC 51 @ Ta=25°C	25 A, 50 A, 90 A, 110 A	DC1: 1A / 5A	25/55/75 Arms
AC 53a @ Ta=25°C	5 A, 15 A, 20 A, 30 A		5/15/20 Arms
Min. operational current	20 mA	1 mA	
Non rep. surge current (t=10 ms)	325 A <sub>p</sub> [RA..25.] 600 A <sub>p</sub> [RA..50.] 1150 A <sub>p</sub> [RA..90.] 1900 A <sub>p</sub> [RA..110.]		325 A <sub>p</sub> [RZ3A..25..] 600 A <sub>p</sub> [RZ3A..55..] 1150 A <sub>p</sub> [RZ3A..75..]
Off-state leakage current	< 3 mA	< 1 mA	< 3 mA
I <sup>2</sup> t for fusing (t=10 ms)	<525 A <sup>2</sup> s [RA..25.] <1800 A <sup>2</sup> s [RA..50.] <6600 A <sup>2</sup> s [RA..90.] <18000 A <sup>2</sup> s [RA..110.]		525 A <sup>2</sup> s [RZ3A..25..] 1800 A <sup>2</sup> s [RZ3A..55..] 6600 A <sup>2</sup> s [RZ3A..75..]
<b>General specifications</b>			
Operational voltage range	24-280 Vrms [RA24.06..] 42-480 Vrms [RA44.08..] 42-530 Vrms [RA48.12..] 24-690 Vrms [RA60.16..]	3-60 VDC [RD0605..D] 3-200 VDC [RD2001..D] 3-350 VDC [RD3501..D]	24-440 Vrms [RZ3A40..] 42-660 Vrms [RZ3A60..]
Blocking voltage	<650 V <sub>p</sub> [RA24.06..] <850 V <sub>p</sub> [RA44.08..] <1200 V <sub>p</sub> [RA48.12..] <1600 V <sub>p</sub> [RA60.16..]		<850 V <sub>p</sub> [RZ3A40..] <1200 V <sub>p</sub> [RZ3A60..]
Power factor	≥ 0.5		
Operating temperature	-20°C to +70°C	-20°C to +70°C	-30°C to +80°C
Terminals	Screw / 5 way plug	Screw type with clamp	Screw type with clamp
Approvals/Marks	CE - UL - CSA	CE - CSA	CE - UL - CSA
<b>References</b>			
230 Vrms	<b>RA24..-D..</b> <b>RA24..LA..</b> <b>RA24..HA..</b>	200VDC: <b>RD2001-D</b> 350VDC: <b>RD3501-D</b>	
400 Vrms	<b>RA44..-D..</b> <b>RA44..LA..</b> <b>RA44..HA..</b>	60VDC: <b>RD0605-D</b>	<b>RZ3A40D..*</b> <b>RZ3A40A..*</b>
480 Vrms	<b>RA48..-D..</b> <b>RA48..LA..</b> <b>RA48..HA..</b>		
600 Vrms	<b>RA60..-D..</b>		<b>RZ3A60D..*</b> <b>RZ3A60A..*</b>

\* Add suffix 'P' for additional integrated Over Temperature Protection

# Solid state relays, 1, 2 and 3-phase

Ready for use design - DIN rail mounting

Types	RMD	RMD2H	RMD3H
Semiconductor contactors with integrated heatsink. AC operating frequency range 45-65 Hz. Rated isolation voltage $\geq 4000$ Vrms.			
Dimensions HxWxD (mm)	81 x 17.5 x 67.2	97 x 140.7 x 50.7	97 x 140.7 x 50.7
Features	Hybrid relay	2ph switching hybrid relay	3ph switching hybrid relay
<b>Input specifications</b>			
Control input range	4-32 VDC [RMD...D20] 24-275 VAC [RMD...A20]	24 VAC/DC +10/-15% [RMD2..LA..] 120 VAC/DC +10/-15% [RMD2..MA..] 240 VAC/DC +10/-15% [RMD2..HA..]	24 VAC/DC +10/-15% [RMD3..LA..] 120 VAC/DC +10/-15% [RMD3..MA..] 240 VAC/DC +10/-15% [RMD3..HA..]
Max. input current	5 mA [RMD..D20] 3 mA [RMD..A20]	400 mA	400 mA
<b>Output specifications</b>			
Rated operational current			
AC 51 @ Ta=25°C	20 A ACrms	30 AAC [RMD2..30] 40 AAC [RMD2..40]	30 AAC [RMD3..30] 40 AAC [RMD3..40]
Min. operational current	100 mA	150 mA	150 mA
<b>General specifications</b>			
Operational voltage range	195-253 Vrms	240 VAC -15%/+10% [RMD..24..] 277 VAC -15%/+10% [RMD..48..]	240 VAC -15%/+10% [RMD..24..] 277 VAC -15%/+10% [RMD..48..] 480 VAC + N [RMD..48..]
Power factor	$\geq 0.9$	$\geq 0.9$ at rated voltage	$\geq 0.9$ at rated voltage
Operating temperature	-5°C to +55°C	0°C to 70°C	0°C to 70°C
Terminals	Box clamp	Input 6.35 mm FASTON, Output screw	Input 6.35 mm FASTON, Output screw
Approvals/Marks	CE - cURus	CE - cURus	CE - cURus
<b>References</b>			
	<b>RMD1H23D20</b>	30 AAC	30 AAC
	<b>RMD1H23A20</b>	<b>RMD2H24LA30</b>	<b>RMD3H24LA30</b>
		<b>RMD2H24MA30</b>	<b>RMD3H24MA30</b>
		<b>RMD2H24HA30</b>	<b>RMD3H24HA30</b>
		40 AAC	<b>RMD3H48LA30</b>
		<b>RMD2H24LA40</b>	<b>RMD3H48MA30</b>
		<b>RMD2H24MA40</b>	<b>RMD3H48HA30</b>
		<b>RMD2H24HA40</b>	40 AAC
			<b>RMD3H24LA40</b>
			<b>RMD3H24MA40</b>
			<b>RMD3H24HA40</b>
			<b>RMD3H48LA40</b>
			<b>RMD3H48MA40</b>
			<b>RMD3H48HA40</b>

# Solid state contactors, 1-phase

Ready for use design - DIN rail mounting, AC output switching

## Types

**RGC1A...15KKE**

**RGC1A...20KKE**

**RGC1A...30KKE**

Single phase, semiconductor contactors with integrated heatsink, LED indication and IP20 protection, AC operating frequency 45-65Hz, Rated isolation voltage  $\geq 4000V_{rms}$ , 100kArms Short Circuit Current Rating, Motor ratings according to UL508



Dimensions HxWxD (mm)

106 x 17.8 x 103.5

106 x 17.8 x 141

106 x 22.5 x 141

Features

17.8mm wide solid state contactor for AC zero cross switching, integrated varistor for overvoltage protection, DC or AC control voltage range, screw terminals with captivated clamp for connection of power terminals and control terminals, E-type layout configuration

17.8mm wide solid state contactor for AC zero cross switching, integrated varistor for overvoltage protection, DC or AC control voltage range, screw terminals with captivated clamp for connection of power terminals and control terminals, E-type layout configuration

22.5mm wide solid state contactor for AC zero cross switching, integrated varistor for overvoltage protection, DC or AC control voltage range, screw terminals with captivated clamp for connection of power terminals and control terminals, E-type layout configuration

## Input Specifications

Control input range	3-32 VDC [RG.23D.] 4-32 VDC [RG.60D.] 20-275 VAC, 24-190 VDC [RG..A.]	3-32 VDC [RG.23D.] 4-32 VDC [RG.60D.] 20-275 VAC, 24-190 VDC [RG..A.]	3-32 VDC [RG.23D.] 4-32 VDC [RG.60D.] 20-275 VAC, 24-190 VDC [RG..A.]
Max. input current	11 mADC [RG..D.] 30 mAAC [RG..A.]	11 mADC [RG..D.] 30 mAAC [RG..A.]	11 mADC [RG..D.] 30 mAAC [RG..A.]

## Output specifications

Rated operational current			
AC 51 @ Ta=40°C	20 AAC	23 AAC	30 AAC
AC 53a @ Ta=40°C	5 AAC	5 AAC	8 AAC [RGC..30.] 10 AAC [RGH..31.]
Min. operational current	150 mA [RGC..15.] 400 mA [RGH..15.]	150 mA [RGC..20.] 250 mA [RGH..20.] 400 mA [RGH..21.]	250 mA [RGC..30.] 400 mA [RGH..31.]
Non rep. surge current (t=10 ms)	325 Ap [RGC..15.] 1150 Ap [RGH..15.]	325 Ap [RGC..20.] 600 Ap [RGH..20.] 1150 Ap [RGH..21.]	600 Ap [RGC..30.] 1150 Ap [RGH..31.]
Off-state leakage current	3 mAAC	3 mAAC	3 mAAC
I <sup>t</sup> for fusing (t=10 ms)	525 A <sup>2</sup> s [RGC..15.] 6600 A <sup>2</sup> s [RGH..15.]	525 A <sup>2</sup> s [RGC..20.] 1800 A <sup>2</sup> s [RGH..20.] 6600 A <sup>2</sup> s [RGH..21.]	1800 A <sup>2</sup> s [RGC..30.] 6600 A <sup>2</sup> s [RGH..31.]
Critical dV/dt off-state	1000 V/μs	1000 V/μs	1000 V/μs

## General specifications

Operational voltage range	24-240 VAC +10% [RG.23..] 42-600 VAC +10% [RG.60..]	24-240 VAC +10% [RG.23..] 42-600 VAC +10% [RG.60..]	24-240 VAC +10% [RG.23..] 42-600 VAC +10% [RG.60..]
Blocking voltage	800 Vp [RGC.23.] 1200 Vp [RGC.60.] 1600 Vp [RGH.60.]	800 Vp [RGC.23.] 1200 Vp [RGC.60.] 1600 Vp [RGH.60.]	800 Vp [RGC.23.] 1200 Vp [RGC.60.] 1600 Vp [RGH.60.]
Power factor	$\geq 0.5$ at rated voltage	$\geq 0.5$ at rated voltage	$\geq 0.5$ at rated voltage
Operating temperature	-40°C to +80°C	-40°C to +80°C	-40°C to +80°C
Approvals/Marks	CE - cULus Listed - VDE - GL [RGC..15.]	CE - cULus Listed - VDE - GL [RGC..20.]	CE - cULus Listed - VDE - GL [RGC..30.]

## References

DC control voltage			
230 VAC, 800Vp	<b>RGC1A23D15KKE</b>	<b>RGC1A23D20KKE</b>	<b>RGC1A23D30KKE</b>
600 VAC, 1200Vp	<b>RGC1A60D15KKE</b>	<b>RGC1A60D20KKE</b>	<b>RGC1A60D30KKE</b>
600 VAC, 1600Vp,1800A <sup>2</sup> s		<b>RGH1A60D20KKE</b>	
600 VAC, 1600Vp,6600A <sup>2</sup> s	<b>RGH1A60D15KKE</b>	<b>RGH1A60D21KKE</b>	<b>RGH1A60D31KKE</b>
AC/DC control voltage			
230 VAC, 800Vp	<b>RGC1A23A15KKE</b>	<b>RGC1A23A20KKE</b>	<b>RGC1A23A30KKE</b>
600 VAC, 1200Vp	<b>RGC1A60A15KKE</b>	<b>RGC1A60A20KKE</b>	<b>RGC1A60A30KKE</b>
600 VAC, 1600Vp,1800A <sup>2</sup> s		<b>RGH1A60A20KKE</b>	
600 VAC, 1600Vp,6600A <sup>2</sup> s	<b>RGH1A60A15KKE</b>	<b>RGH1A60A21KKE</b>	<b>RGH1A60A31KKE</b>



Instant On (Random) Switching available (RGC1B60D...)

CARLO GAVAZZI Automation Components. Specifications are subject to change without notice. Illustrations are for example only.



# Solid state contactors, 1-phase

Ready for use design - DIN rail mounting AC Output Switching

Types	RGC1A...15MKE	RGC1A...20MKE	RGC1A...30MKE
Single phase, semiconductor contactors with integrated heatsink, LED indication and IP20 protection, AC operating frequency 45-65Hz, Rated isolation voltage $\geq$ 4000Vrms, 100kArms Short Circuit Current Rating, Motor ratings according to UL508			
Dimensions HxWxD (mm)	106 x 17.8 x 114.5	106 x 17.8 x 152	106 x 22.5 x 152
Features	17.8mm wide solid state contactor for AC zero cross switching, integrated varistor for overvoltage protection, DC or AC control voltage range, screw terminals with captivated clamp for connection of power terminals and control terminals, E-type layout configuration	17.8mm wide solid state contactor for AC zero cross switching, integrated varistor for overvoltage protection, DC or AC control voltage range, screw terminals with captivated clamp for connection of power terminals and control terminals, E-type layout configuration	22.5mm wide solid state contactor for AC zero cross switching, integrated varistor for overvoltage protection, DC or AC control voltage range, screw terminals with captivated clamp for connection of power terminals and control terminals, E-type layout configuration

## Input Specifications

Control input range	3-32 VDC [RG.23D.] 4-32 VDC [RG.60D.] 20-275 VAC, 24-190 VDC [RG..A.]	3-32 VDC [RG.23D.] 4-32 VDC [RG.60D.] 20-275 VAC, 24-190 VDC [RG..A.]	3-32 VDC [RG.23D.] 4-32 VDC [RG.60D.] 20-275 VAC, 24-190 VDC [RG..A.]
Max. input current	11 mADC [RG..D.] 30 mAAC [RG..A.]	11 mADC [RG..D.] 30 mAAC [RG..A.]	11 mADC [RG..D.] 30 mAAC [RG..A.]

## Output specifications

Rated operational current			
AC 51 @ Ta=40°C	20 AAC	23 AAC	30 AAC
AC 53a @ Ta=40°C	5 AAC	5 AAC	8 AAC [RG..30.] 10 AAC [RGH..31.]
Min. operational current	150 mA [RGC..15.] 400 mA [RGH..15.]	150 mA [RGC..20.] 250 mA [RGH..20.] 400 mA [RGH..21.]	250 mA [RGC..30.] 400 mA [RGH..31.]
Non rep. surge current (t=10 ms)	325 Ap [RGC..15.] 1150 Ap [RGH..15.]	325 Ap [RGC..20.] 600 Ap [RGH..20.] 1150 Ap [RGH..21.]	600 Ap [RGC..30.] 1150 Ap [RGH..31.]
Off-state leakage current	3 mAAC	3 mAAC	3 mAAC
I <sup>t</sup> for fusing (t=10 ms)	525 A <sup>2</sup> s [RGC..15.] 6600 A <sup>2</sup> s [RGH..15.]	525 A <sup>2</sup> s [RGC..20.] 1800 A <sup>2</sup> s [RGH..20.] 6600 A <sup>2</sup> s [RGH..21.]	1800 A <sup>2</sup> s [RGC..30.] 6600 A <sup>2</sup> s [RGH..31.]
Critical dV/dt off-state	1000 V/μs	1000 V/μs	1000 V/μs

## General specifications

Operational voltage range	24-240 VAC +10% [RG.23..] 42-600 VAC +10% [RG.60..]	24-240 VAC +10% [RG.23..] 42-600 VAC +10% [RG.60..]	24-240 VAC +10% [RG.23..] 42-600 VAC +10% [RG.60..]
Blocking voltage	800 Vp [RGC.23.] 1200 Vp [RGC.60.] 1600 Vp [RGH.60.]	800 Vp [RGC.23.] 1200 Vp [RGC.60.] 1600 Vp [RGH.60.]	800 Vp [RGC.23.] 1200 Vp [RGC.60.] 1600 Vp [RGH.60.]
Power factor	$\geq$ 0.5 at rated voltage	$\geq$ 0.5 at rated voltage	$\geq$ 0.5 at rated voltage
Operating temperature	-40°C to +80°C	-40°C to +80°C	-40°C to +80°C
Approvals/Marks	CE - cULus Listed - VDE - GL [RGC..15.]	CE - cULus Listed - VDE - GL [RGC..20.]	CE - cULus Listed - VDE - GL [RGC..30.]

## References



DC control voltage			
230 VAC, 800Vp	RGC1A23D15MKE	RGC1A23D20MKE	RGC1A23D30MKE
600 VAC, 1200Vp	RGC1A60D15MKE	RGC1A60D20MKE	RGC1A60D30MKE
600 VAC, 1600Vp, 1800A <sup>2</sup> s		RGH1A60D20MKE	
600 VAC, 1600Vp, 6600A <sup>2</sup> s	RGH1A60D15MKE	RGH1A60D21MKE	RGH1A60D31MKE
AC/DC control voltage			
230 VAC, 800Vp	RGC1A23A15MKE	RGC1A23A20MKE	RGC1A23A30MKE
600 VAC, 1200Vp	RGC1A60A15MKE	RGC1A60A20MKE	RGC1A60A30MKE
600 VAC, 1600Vp, 1800A <sup>2</sup> s		RGH1A60A20MKE	
600 VAC, 1600Vp, 6600A <sup>2</sup> s	RGH1A60A15MKE	RGH1A60A21MKE	RGH1A60A31MKE

Instant On (Random) Switching available on request (RGC1B60D...)

CARLO GAVAZZI Automation Components. Specifications are subject to change without notice. Illustrations are for example only.

# Solid state contactors, 1-phase



Ready for use design - DIN rail mounting AC Output Switching

Types	RGC1A...15KGU	RGC1A...20KGU	RGC1A...30KGU
Single phase, semiconductor contactors with integrated heatsink, LED indication and IP20 protection, AC operating frequency 45-65Hz, Rated isolation voltage $\geq 4000V_{rms}$ , 100kArms Short Circuit Current Rating, Motor ratings according to UL508			
Dimensions HxWxD (mm)	106 x 17.8 x 103.5	106 x 17.8 x 141	106 x 22.5 x 141
Features	17.8mm wide solid state contactor for AC zero cross switching, integrated varistor for overvoltage protection, DC or AC control voltage range, screw terminals with captivated clamp for connection of control terminals and box clamps for power terminals, U-type layout configuration	17.8mm wide solid state contactor for AC zero cross switching, integrated varistor for overvoltage protection, DC or AC control voltage range, screw terminals with captivated clamp for connection of control terminals and box clamps for power terminals, U-type layout configuration	22.5mm wide solid state contactor for AC zero cross switching, integrated varistor for overvoltage protection, DC or AC control voltage range, screw terminals with captivated clamp for connection of control terminals and box clamps for power terminals, U-type layout configuration
<b>Input Specifications</b>			
Control input range	3-32 VDC [RG.23D.] 4-32 VDC [RG.60D.] 20-275 VAC, 24-190 VDC [RG..A.]	3-32 VDC [RG.23D.] 4-32 VDC [RG.60D.] 20-275 VAC, 24-190 VDC [RG..A.]	3-32 VDC [RG.23D.] 4-32 VDC [RG.60D.] 20-275 VAC, 24-190 VDC [RG..A.]
Max. input current	11 mADC [RG..D.] 30 mAAC [RG..A.]	11 mADC [RG..D.] 30 mAAC [RG..A.]	11 mADC [RG..D.] 30 mAAC [RG..A.]
<b>Output specifications</b>			
Rated operational current			
AC 51 @ Ta=40°C	20 AAC	23 AAC	30 AAC
AC 53a @ Ta=40°C	5 AAC	5 AAC	8 AAC
Min. operational current	150 mA	150 mA	250 mA
Non rep. surge current (t=10 ms)	325 Ap	325 Ap	600 Ap
Off-state leakage current	3 mAAC	3 mAAC	3 mAAC
I <sup>2</sup> t for fusing (t=10 ms)	525 A <sup>2</sup> s	525 A <sup>2</sup> s	1800 A <sup>2</sup> s
Critical dV/dt (@ Tj init = 25°C)	1000 V/μs	1000 V/μs	1000 V/μs
<b>General specifications</b>			
Operational voltage range	24-240 VAC +10% [RG.23..] 42-600 VAC +10% [RG.60..]	24-240 VAC +10% [RG.23..] 42-600 VAC +10% [RG.60..]	24-240 VAC +10% [RG.23..] 42-600 VAC +10% [RG.60..]
Blocking voltage	800 Vp [RGC.23.] 1200 Vp [RGC.60.]	800 Vp [RGC.23.] 1200 Vp [RGC.60.]	800 Vp [RGC.23.] 1200 Vp [RGC.60.]
Power factor	$\geq 0.5$ at rated voltage	$\geq 0.5$ at rated voltage	$\geq 0.5$ at rated voltage
Operating temperature	-40°C to +80°C	-40°C to +80°C	-40°C to +80°C
Approvals/Marks	CE - cULus Listed - VDE - GL	CE - cULus Listed - VDE - GL	CE - cULus Listed - VDE - GL
<b>References</b>			
DC control voltage			
230 VAC, 800Vp	<b>RGC1A23D15KGU</b>	<b>RGC1A23D20KGU</b>	<b>RGC1A23D30KGU</b>
600 VAC, 1200Vp	<b>RGC1A60D15KGU</b>	<b>RGC1A60D20KGU</b>	<b>RGC1A60D30KGU</b>
AC/DC control voltage			
230 VAC, 800Vp	<b>RGC1A23A15KGU</b>	<b>RGC1A23A20KGU</b>	<b>RGC1A23A30KGU</b>
600 VAC, 1200Vp	<b>RGC1A60A15KGU</b>	<b>RGC1A60A20KGU</b>	<b>RGC1A60A30KGU</b>

Instant On (Random) Switching available on request (RGC1B60D...)

# Solid state contactors, 1-phase

Ready for use design - DIN rail mounting AC Output Switching

Types	RGC1A...40KGE	RGC1A...40MGE	RGC1A...60KGE
Single phase, semiconductor contactors with integrated heatsink, LED indication and IP20 protection, AC operating frequency 45-65Hz, Rated isolation voltage $\geq$ 4000Vrms, 100kArms Short Circuit Current Rating, Motor ratings according to UL508			
Dimensions HxWxD (mm)	106 x 35.6 x 141	106 x 35.6 x 152	106 x 69.1 x 141
Features	35mm wide solid state contactor for AC zero cross switching, integrated varistor for overvoltage protection, DC or AC control voltage range, screw terminals with captivated clamp for connection of control terminals and box clamps for power terminals, E-type layout configuration	35mm wide solid state contactor for AC zero cross switching, integrated varistor for overvoltage protection, DC or AC control voltage range, spring loaded plug for connection of control terminals and box clamps for power terminals, E-type layout configuration	70mm wide solid state contactor for AC zero cross switching, integrated varistor for overvoltage protection, DC or AC control voltage range, screw terminals with captivated clamp for connection of control terminals and box clamps for power terminals, E-type layout configuration

Input Specifications			
Control input range	3-32 VDC [RG.23D.] 4-32 VDC [RG.60D.] 20-275 VAC, 24-190 VDC [RG..A.]	3-32 VDC [RG.23D.] 4-32 VDC [RG.60D.] 20-275 VAC, 24-190 VDC [RG..A.]	3-32 VDC [RG.23D.] 4-32 VDC [RG.60D.] 20-275 VAC, 24-190 VDC [RG..A.]
Max. input current	11 mADC [RG..D.] 30 mAAC [RG..A.]	11 mADC [RG..D.] 30 mAAC [RG..A.]	11 mADC [RG..D.] 30 mAAC [RG..A.]

Output specifications			
Rated operational current			
AC 51 @ Ta=40°C	40 AAC	40 AAC	60 AAC
AC 53a @ Ta=40°C	13 AAC [RGC...40.] 10 AAC [RGH...40.] 13 AAC [RGH...41.]	13 AAC [RGC...40.] 10 AAC [RGH...40.] 13 AAC [RGH...41.]	14.8 AAC [RGC...60.] 18.0 AAC [RGH...60.]
Min. operational current	400 mA [RGC...40.] 250 mA [RGH...40.] 400 mA [RGH...41.]	400 mA [RGC...40.] 250 mA [RGH...40.] 400 mA [RGH...41.]	400 mA
Non rep. surge current (t=10 ms)	800 Ap [RGC...40.] 600 Ap [RGH...40.] 1150 Ap [RGH...41..]	800 Ap [RGC...40.] 600 Ap [RGH...40.] 1150 Ap [RGH...41..]	800 Ap [RGC...60.] 1150 Ap [RGH...60.]
Off-state leakage current	3 mAAC	3 mAAC	3 mAAC
I <sup>t</sup> for fusing (t=10 ms)	3200 A <sup>2</sup> s [RGC...40..] 1800 A <sup>2</sup> s [RGH...40..] 6600 A <sup>2</sup> s [RGH...41..]	3200 A <sup>2</sup> s [RGC...40..] 1800 A <sup>2</sup> s [RGH...40..] 6600 A <sup>2</sup> s [RGH...41..]	3200 A <sup>2</sup> s [RGC...60..] 6600 A <sup>2</sup> s [RGH...60..]
Critical dV/dt off-state	1000 V/μs	1000 V/μs	1000 V/μs

General specifications			
Operational voltage range	24-240 VAC +10% [RG.23..] 42-600 VAC +10% [RG.60..]	24-240 VAC +10% [RG.23..] 42-600 VAC +10% [RG.60..]	24-240 VAC +10% [RG.23..] 42-600 VAC +10% [RG.60..]
Blocking voltage	800 Vp [RGC.23.] 1200 Vp [RGC.60.] 1600 Vp [RGH.60.]	800 Vp [RGC.23.] 1200 Vp [RGC.60.] 1600 Vp [RGH.60.]	800 Vp [RGC.23.] 1200 Vp [RGC.60.] 1600 Vp [RGH.60.]
Power factor	$\geq$ 0.5 at rated voltage	$\geq$ 0.5 at rated voltage	$\geq$ 0.5 at rated voltage
Operating temperature	-40°C to +80°C	-40°C to +80°C	-40°C to +80°C
Approvals/Marks	CE - cULus Listed - VDE	CE - cULus Listed - VDE	CE - cULus Listed - VDE

References			
DC control voltage			
230 VAC, 800Vp	RGC1A23D40KGE	RGC1A23D40MGE	RGC1A23D60KGE
600 VAC, 1200Vp	RGC1A60D40KGE	RGC1A60D40MGE	RGC1A60D60KGE
600 VAC, 1600Vp,1800A <sup>2</sup> s	RGH1A60D40KGE		
600 VAC, 1600Vp,6600A <sup>2</sup> s	RGH1A60D41KGE	RGH1A60D41MGE	RGH1A60D60KGE
AC/DC control voltage			
230 VAC, 800Vp	RGC1A23A40KGE	RGC1A23A40MGE	RGC1A23A60KGE
600 VAC, 1200Vp	RGC1A60A40KGE	RGC1A60A40MGE	RGC1A60A60KGE
600 VAC, 1600Vp,1800A <sup>2</sup> s	RGH1A60A40KGE		
600 VAC, 1600Vp,6600A <sup>2</sup> s	RGH1A60A41KGE	RGH1A60A41MGE	RGH1A60A60KGE

Instant On (Random) Switching available (RGC1B60D...)



CARLO GAVAZZI Automation Components. Specifications are subject to change without notice. Illustrations are for example only.

# Solid state contactors, 1-phase

Ready for use design - DIN rail mounting

AC Output Switching



DC Output Switching

Types	RGC1A...40KGU	RGC1A...60KGU	RGC1D...KKE
Single phase, semiconductor contactors with integrated heatsink, LED indication and IP20 protection, AC operating frequency 45-65Hz, Rated isolation voltage $\geq 4000V_{rms}$ , 100kArms Short Circuit Current Rating, Motor ratings according to UL508			
Dimensions HxWxD (mm)	106 x 35.6 x 141	106 x 69.1 x 141	106 x 17.8 x 141
Features	35mm wide solid state contactor for AC zero cross switching, integrated varistor for overvoltage protection, DC or AC control voltage range, screw terminals with captivated clamp for connection of control terminals and box clamps for power terminals, U-type layout configuration	70mm wide solid state contactor for AC zero cross switching, integrated varistor for overvoltage protection, DC or AC control voltage range, screw terminals with captivated clamp for connection of control terminals and box clamps for power terminals, U-type layout configuration	17.8mm wide solid state contactor for DC switching, integrated free wheeling diode for protection, DC control voltage range, screw terminals with captivated clamp for connection of control terminals and power terminals, E-type layout configuration
<b>Input Specifications</b>			
Control input range	3-32 VDC [RG.23D.] 4-32 VDC [RG.60D.] 20-275 VAC, 24-190 VDC [RG..A.]	3-32 VDC [RG.23D.] 4-32 VDC [RG.60D.] 20-275 VAC, 24-190 VDC [RG..A.]	4.5-32 VDC
Max. input current	11 mADC [RG..D.] 30 mAAC [RG..A.]	11 mADC [RG..D.] 30 mAAC [RG..A.]	13.7 mADC
<b>Output specifications</b>			
Rated operational current			
AC 51 @ Ta=40°C	40 AAC	60 AAC	
AC 53a @ Ta=40°C	13 AAC [RGC...40.] 13 AAC [RGH...41.]	14.8 AAC [RGC...60.] 18.0 AAC [RGH...60.]	
DC-1 @ 60°C			8 ADC
Min. operational current	400 mA	400 mA	20 mA
Non rep. surge current (t=10 ms)	800 Ap [RGC...40.] 1150 Ap [RGH...41.]	800 Ap [RGC...60.] 1150 Ap [RGH...60.]	200 ADC (10 $\mu$ s)
Off-state leakage current	3 mAAC	3 mAAC	1.5 mADC
I <sup>t</sup> for fusing (t=10 ms)	3200 A <sup>2</sup> s [RGC...40.] 6600 A <sup>2</sup> s [RGH...41.]	3200 A <sup>2</sup> s [RGC...60.] 6600 A <sup>2</sup> s [RGH...60.]	
Critical dV/dt off-state	1000 V/ $\mu$ s	1000 V/ $\mu$ s	1000 V/ $\mu$ s
<b>General specifications</b>			
Operational voltage range	24-240 VAC +10% [RG.23..] 42-600 VAC +10% [RG.60..]	24-240 VAC +10% [RG.23..] 42-600 VAC +10% [RG.60..]	24-240 VAC +10% [RG.23..] 42-600 VAC +10% [RG.60..]
Blocking voltage	800 Vp [RGC.23.] 1200 Vp [RGC.60.] 1600 Vp [RGH.60.]	800 Vp [RGC.23.] 1200 Vp [RGC.60.] 1600 Vp [RGH.60.]	1200 VDC
Power factor	$\geq 0.5$ at rated voltage	$\geq 0.5$ at rated voltage	
Operating temperature	-40°C to +80°C	-40°C to +80°C	-40°C to +80°C
Approvals/Marks	CE - cULus Listed - VDE	CE - cULus Listed - VDE	CE - cULus Listed
<b>References</b>			
DC control voltage			
230 VAC, 800Vp	RGC1A23D40KGU	RGC1A23D60KGU	
600 VAC, 1200Vp	RGC1A60D40KGU	RGC1A60D60KGU	
600 VAC, 1600Vp,6600A <sup>2</sup> s 1000 VDC	RGH1A60D41KGU	RGH1A60D60KGU	RGC1D1000D15KKE
AC/DC control voltage			
230 VAC, 800Vp	RGC1A23A40KGU	RGC1A23A60KGU	
600 VAC, 1200Vp	RGC1A60A40KGU	RGC1A60A60KGU	
600 VAC, 1600Vp,6600A <sup>2</sup> s	RGH1A60A41KGU	RGH1A60A60KGU	

Instant On (Random) Switching available (RGC1B60D...)

# Solid state contactors, 1-phase

Ready for use design - DIN rail mounting  
AC Output Switching with Integrated Over Temperature Protection

Types	RGC1A...20GKEP	RGC1A...30GKEP	RGC1A60.40GG.P
Single phase, semiconductor contactors with integrated heatsink, LED indication and IP20 protection, AC operating frequency 45-65Hz, Rated isolation voltage $\geq$ 4000Vrms, 100kArms Short Circuit Current Rating, Motor ratings according to UL508			
Dimensions HxWxD (mm)	106 x 22.5 x 168	106 x 22.5 x 168	108 x 35.6 x 168
Features	22.5mm wide solid state contactor for AC zero cross switching, integrated varistor for overvoltage protection and integrated over temperature for protection against over heating, DC or AC control voltage range, screw terminals with captivated clamp for connection of power terminals and box clamps for control terminals	22.5mm wide solid state contactor for AC zero cross switching, integrated varistor for overvoltage protection and integrated over temperature for protection against over heating, DC or AC control voltage range, screw terminals with captivated clamp for connection of power terminals and box clamps for control terminals	35mm wide solid state contactor for AC zero cross switching, integrated varistor for overvoltage protection and integrated over temperature for protection against over heating, DC or AC control voltage range, box clamps for connection of power and control terminals
<b>Input Specifications</b>			
Control input range	5-32 VDC [RG.D.] 20-275 VAC, 24-190 VDC [RG..A.]	5-32 VDC [RG.D.] 20-275 VAC, 24-190 VDC [RG..A.]	5-32 VDC [RG.D.] 20-275 VAC, 24-190 VDC [RG..A.]
Max. input current	24 mA DC [RG..D.] 35 mA AC [RG..A.]	24 mA DC [RG..D.] 35 mA AC [RG..A.]	24 mA DC [RG..D.] 35 mA AC [RG..A.]
<b>Supply Voltage</b>			
Rated supply voltage	24 VDC -15%, +20%	24 VDC -15%, +20%	24 VDC -15%, +20%
Max. current rating	50 mA DC	50 mA DC	50 mA DC
<b>Over Temperature Alarm</b>			
Alarm output	PNP open collector normally closed, max. 24 VDC / 50 mA [RGC.D.P]  Potential free normally closed, max. 24 VDC / 50 mA [RGC.A.P]	PNP open collector normally closed, max. 24 VDC / 50 mA [RGC.D.P]  Potential free normally closed, max. 24 VDC / 50 mA [RGC.A.P]	PNP open collector normally closed, max. 24 VDC / 50 mA [RGC.D.P]  Potential free normally closed, max. 24 VDC / 50 mA [RGC.A.P]
<b>Output Specifications</b>			
Rated operational current			
AC 51 @ Ta=40°C	23 AAC	30 AAC	40 AAC
AC 53a @ Ta=40°C	5 AAC	8 AAC	13 AAC
Min. operational current	150 mA	250 mA	400 mA
Non rep. surge current (t=10 ms)	325 Ap	600 Ap	800 Ap
Off-state leakage current	3 mA AC	3 mA AC	3 mA AC
I <sup>2</sup> t for fusing (t=10 ms)	525 A <sup>2</sup> s	1800 A <sup>2</sup> s	3200 A <sup>2</sup> s
Critical dV/dt off-state (@ Tj init = 25°C)	1000 V/μs	1000 V/μs	1000 V/μs
<b>General specifications</b>			
Operational voltage range	24-240 VAC +10% [RG.23..] 42-600 VAC +10% [RG.60..]	24-240 VAC +10% [RG.23..] 42-600 VAC +10% [RG.60..]	24-240 VAC +10% [RG.23..] 42-600 VAC +10% [RG.60..]
Blocking voltage	800 Vp [RGC.23.] 1200 Vp [RGC.60.]	800 Vp [RGC.23.] 1200 Vp [RGC.60.]	1200 Vp
Power factor	$\geq$ 0.5 at rated voltage	$\geq$ 0.5 at rated voltage	$\geq$ 0.5 at rated voltage
Operating temperature	-40°C to +70°C	-40°C to +70°C	-40°C to +70°C
Approvals/Marks	CE - cULus Listed - VDE	CE - cULus Listed - VDE	CE - cULus Listed - VDE
<b>References</b>			
DC control voltage			
230 VAC, 800Vp	<b>RGC1A23D20GKEP</b>	<b>RGC1A23D30GKEP</b>	
600 VAC, 1200Vp	<b>RGC1A60D20GKEP</b>	<b>RGC1A60D30GKEP</b>	<b>RGC1A60D40GGXP</b>
AC/DC control voltage			
600 VAC, 1200Vp	<b>RGC1A60A20GKEP</b>	<b>RGC1A60A30GKEP</b>	<b>RGC1A60A40GGXP</b>

X must be replaced with the following depending on the connection configuration required

Configuration X: E = E-type U = U-type

# Solid state contactors, 1-phase

Ready for use design - DIN rail mounting, AC Output Switching  
Integrated Over Temperature Protection Integrated Fuse

**Types** **RGC1A60.60GG.P** **RGC1A...90GG.P** **RGC1F...D..GGE**

Single phase, semiconductor contactors with integrated heatsink, LED indication and IP20 protection, AC operating frequency 45-65Hz, Rated isolation voltage  $\geq 4000V_{rms}$ , 100kArms Short Circuit Current Rating, Motor ratings according to UL508



Dimensions HxWxD (mm) 106 x 69.1 x 168 126 x 69.1 x 168 (with fan) 106 x 35.6 x 168

**Features**  
 70mm wide solid state contactor for AC zero cross switching, integrated varistor for overvoltage protection and integrated over temperature for protection against over heating, DC or AC control voltage range, box clamps for connection of power & control terminals  
 70mm wide solid state contactor for AC zero cross switching with attached fan, integrated varistor for overvoltage protection and integrated over temperature for protection against over heating, DC or AC control voltage range, box clamps for connection of power & control terminals  
 35mm wide solid state contactor for AC zero cross switching with integrated fuse, additional monitoring features available with RGC1FS.. versions for SSR, load & fuse failure detection, integrated varistor for overvoltage protection, DC control voltage range, box clamps for connection of power & control terminals

## Input Specifications

Control input range 5-32 VDC [RG.D.] 20-275 VAC, 24-190 VDC [RG..A.] 5-32 VDC [RG.D.] 20-275 VAC, 24-190 VDC [RG..A.] 3-32 VDC [RGC1F.] 4.5-32 VDC [RGC1FA60.]  
 Max. input current 23 mADC [RG..D.]/35 mAAC [RG..A.] 23 mADC [RG..D.]/ 35 mAAC [RG..A.] 12 mA

## Supply Voltage

Rated supply voltage 24 VDC -15%, +20% 24 VDC -15%, +20% 24 VDC -15%, +20%  
 Max. current rating 50 mADC 50 mADC (fan rating 24 VDC / 50 mA) 80 mADC

## Over Temperature Alarm

Alarm output PNP open collector normally closed, max. 24 VDC / 50 mA [RGC.D.P] PNP open collector normally closed, max. 24 VDC / 50 mA [RGC.D.P] PNP open collector normally closed, max. 24 VDC / 50 mA [RGC1FS..]  
 Potential free normally closed, max. 24 VDC / 50 mA [RGC.D.P] Potential free normally closed, max. 24 VDC / 50 mA [RGC.D.P]

## Output Specifications

Rated operational current  
 AC 51 @ Ta=40°C 60 AAC 85 AAC 20 AAC [RGC1F..20.]/30 AAC [RGC1F..30.]/40 AAC [RGC1F..40.]  
 AC 53a @ Ta=40°C 14,8 AAC 18 AAC 4.7 AAC [RGC1F..20.]/6 AAC [RGC1F..30.]/ 8 AAC [RGC1F..40.]  
 Min. operational current 400 mA 400 mA 200 mA  
 Non rep. surge current (t=10 ms) 800 Ap 1150 Ap Integrated fuse  
 Off-state leakage current 3 mAAC 3 mAAC  
 I<sup>t</sup> for fusing (t=10 ms) 3200 A<sup>2</sup>s 6600 A<sup>2</sup>s Fuse - 740A<sup>2</sup>s [RGC1F..20..] Fuse - 1400A<sup>2</sup>s [RGC1F..30..] Fuse - 3100A<sup>2</sup>s [RGC1F..40..]  
 Critical dV/dt off-state (@ Tj init = 25°C) 1000 V/μs 1000 V/μs

## General specifications

Operational voltage range 42-600 VAC +10% [RG.60...] 24-240 VAC +10% [RG.23..] 42-600 VAC +10% [RG.60..] 24-240 VAC +10% [RG.23..] 42-600 VAC +10% [RG.60..]  
 Blocking voltage 1200 Vp 800 Vp [RGC.23.]/1200 Vp [RGC.60.] 1200 Vp  
 Power factor  $\geq 0.5$  at rated voltage  $\geq 0.5$  at rated voltage  $\geq 0.5$  at rated voltage  
 Operating temperature -40°C to +70°C -40°C to +70°C -40°C to +70°C  
 Approvals/Marks CE - cULus Listed - VDE CE - cULus Listed - VDE CE - cULus Listed



## References

DC control voltage  
 230 VAC, 800Vp RGC1A23D90GGXP 20 AAC RGC1FY23D20GGE  
 30 AAC RGC1FY23D20GGE  
 40 AAC RGC1FY23D20GGE  
 600 VAC, 1200Vp RGC1A60D60GGXP RGC1A60D90GGXP 20 AAC RGC1FY60D20GGE  
 30 AAC RGC1FY60D20GGE  
 40 AAC RGC1FY60D20GGE  
 AC/DC control voltage  
 600 VAC, 1200Vp RGC1A60A60GGXP RGC1A60A90GGXP

X and Y must be replaced with the following depending on the version required  
 Configuration X: E = E-type U = U-type  
 Version Y: A = fuse only S = fuse + monitoring

# Solid state contactors, 1-phase

Ready for use design - DIN rail mounting

Types	RJCS	RJ1P MB	RJ1P
Semiconductor contactors with integrated heatsink. AC operating frequency range 45-65 Hz. Rated isolation voltage $\geq 4000$ Vrms.			
Dimensions HxWxD (mm)	103 x 45 x 103	103 x 45 x 122	103 x 45 x 103
Features	Integrated under-current monitoring, integrated overtemperature protection	SSR with fieldbus communication interface	Multifunction Phase-angle, Distributed full cycle and Burst control (1s, 3s and 10s)
<b>Control specifications</b>			
Control input range	4-32 VDC	2-wire Modbus RTU	4-20 mA [RJ1P...I...] 0-10 VDC [RJ1P...V...]
Max. input current	2 mA		50 mA [RJ1P...I...] 0-1mA [RJ1P...V...]
Control supply	24 VDC		24 VAC/DC [RJ1P...V...]
Max. input current	25 mA		23 mA [RJ1P...V...]
<b>Output specifications</b>			
Rated operational current			
AC 51 @ Ta=25°C	30 / 50 Arms	50 AACrms	30 / 50 Arms
AC 53a @ Ta=25°C	30 Arms		
Min. TEACH/operational current	0.3 / 0.5 Arms	500 mAACrms	150 mArms/ 500mArms
Non-repet. surge current (t=10 ms)	600 / 1900 A <sub>p</sub>	1900 A <sub>p</sub>	325/1900 A <sub>p</sub>
Off-state leakage current	< 3 mArms	< 3 mArms	< 3 mArms
I <sup>2</sup> t for fusing (t=10 ms)	1800 A <sup>2</sup> s / 18000 A <sup>2</sup> s	18000 A <sup>2</sup> s	525 A <sup>2</sup> s / 18000 A <sup>2</sup> s
On state voltage drop	1.6 Vrms	1.6 Vrms	1.6 Vrms
Critical dV/dt off-state	1000 V/μs	1000 V/μs	1000 V/μs
<b>General specifications</b>			
Operational voltage range	24-265 Vrms [RJCS23..] 42-660 Vrms [RJCS60..]	90-265 Vrms	90-265 Vrms [RJ1P23..] 200-550 Vrms [RJ1P48..] 410-660 Vrms [RJ1P60..]
Blocking voltage	650 V <sub>p</sub> [RJCS23..] 1200 V <sub>p</sub> [RJCS60..]		650 V <sub>p</sub> [RJP23..] 1200 V <sub>p</sub> [RJ1P48..] 1200 V <sub>p</sub> [RJ1P60..]
Power factor	$\geq 0.5$	$\geq 0.9$ @ 230 VACrms	$\geq 0.9$
Operating temperature	-20° to +60°C	-30° to +70°C	-20° to +60°C
Terminals	Box clamp	Box clamp	Box clamp
Approvals/Marks	CE - UL - cUL	CE - UL - cUL	CE - UL - cUL
<b>References</b>			
1-phase, zero switching	30 / 50 A	50 A	30 / 50 A
230 V	RJCSR1A23D30EPNO	RJ1P23MBT50EBC	RJ1P23V30E
	RJCSR1A23D30EPPO	RJ1P23MBT50ECS	RJ1P23I30E
	RJCSR1A23D50EPPO		RJ1P23V50E
	RJCSR1A23D50EPPO		RJ1P23I50E
480 V		RJ1P48MBT50EBC	RJ1P48V30E
		RJ1P48MBT50ECS	RJ1P48I30E
		RJ1P48MBT50ECV	RJ1P48V50E
600 V			RJ1P48I50E
	RJCSR1A60D30EPNO	RJ1P60MBT50EBC	RJ1P60V30E
	RJCSR1A60D30EPPO	RJ1P60MBT50ECS	RJ1P60I30E
	RJCSR1A60D50EPPO	RJ1P60MBT50ECV	RJ1P60V50E
	RJCSR1A60D50EPPO		RJ1P60I50E

# Solid state contactors, 1-phase, 2-phase

Ready to use design - DIN rail mounting - Zero switching

Types	Solitron RN Full Cycle 1 pole 30/50 A	Solitron RN Sense* 1 pole 30/50 A	Solitron RN Sense* 2 poles 30/50 A
-------	--	--------------------------------------	---------------------------------------

Semiconductor contactors with integrated heatsink. AC operating frequency range 45-65 Hz. Rated isolation voltage  $\geq 4000$  Vrms.



Dimensions HxWxD (mm)	120 x 45 x 110 (30A) 120 x 90 x 110 (50/63 A)	120 x 45 x 110 (30A) 120 x 90 x 110 (50A)	120 x 45 x 110 (30A) 120 x 90 x 110 (50A)
Features	High precision temperature control	High precision economy switching	High precision economy switching

## Control specifications

Control input range	4-20 mA [RN.F.I.] 0-10 VDC [RN.F.V.]	7-32 VDC	4-20 mA [RN.F.I.] 0-10 VDC [RN.F.V.]
Max. input current	50 mA [RN.F.I.] 0.1 mA [RN.F.V.]	4 mA	50 mA [RN.F.I.] 0.1 mA [RN.F.V.]
Control supply	12-32 VDC / 24 VAC [RN.V.]	20-32 VDC ( $\leq 40$ mA)	7-10 VDC [RN.F.I.] 12-32 VDC/24 VAC [RN.V.]
Alarm output	PNP NPN	VCC - 2 VDC ( $\leq 100$ mA) 2 VDC @ ( $\leq 100$ mA)	

## Output specifications

Rated operational current			
AC 51 @ Ta=30°C	30 Arms [RN.F..30] 50 Arms [RN.F..50]	30 Arms [RN1S...30..] 50 Arms [RN1S...50..]	30 A total sum [RN.F..30] 50 A total sum [RN.F..50]
AC 53a @ Ta=40°C		6 Arms [RN1S...30..] 12 Arms [RN1S...50..]	
Min. operational current	500 mArms	200 mArms	500 mArms
Non rep. surge current (t=10 ms)	325 A <sub>p</sub> [RN..30] 600 A <sub>p</sub> [RN..50]	325 A <sub>p</sub> [RN1S...30..] 600 A <sub>p</sub> [RN1S...50..]	325 A <sub>p</sub> [RN.F..30] 600 A <sub>p</sub> [RN.F..50]
Off-state leakage current	< 6 mAAC	< 6 mAAC	< 6 mArms
I <sup>2</sup> t for fusing (t=10 ms)	525 A <sup>2</sup> s [RN.F..30] 1800 A <sup>2</sup> s [RN.F..50]	525 A <sup>2</sup> s [RN1S...30..] 1800 A <sup>2</sup> s [RN1S...50..]	525 A <sup>2</sup> s [RN.F..30] 1800 A <sup>2</sup> s [RN.F..50]

## General specifications

Operational voltage range	85-140 Arms [RN..F12..] 85-265 Arms [RN..F23..] 190-530 Arms [RN..F48..]	120-265 Arms [RN1S23..] 150-440 Arms [RN1S40..] 180-530 Arms [RN1S48..]	85-140 Vrms [RN..F12..] 85-265 Vrms [RN..F23..] 190-530 Vrms [RN..F48..]
Blocking voltage	800 V <sub>p</sub> [RN..F12..] 800 V <sub>p</sub> [RN..F23..] 1000 V <sub>p</sub> [RN..F48..]	800 V <sub>p</sub> [RN1S23..] 1000 V <sub>p</sub> [RN1S40..] 1200 V <sub>p</sub> [RN1S48..]	800 V <sub>p</sub> [RN..F12..] 800 V <sub>p</sub> [RN..F23..] 1000 V <sub>p</sub> [RN..F48..]
Power factor	$\geq 0.9$	$\geq 0.5$	$\geq 0.9$
Operating temperature	-20°C to +70°C	-20°C to +70°C	-20°C to +70°C
Terminals	Screw captive wire clamp	Screw captive wire clamp	Screw with captive wire clamp
Approvals/Marks	CE - UL - CSA	CE - UL - CSA	CE - UL - CSA

## References





30 A	<b>RN1F12I30</b>	30 A	<b>RN1S23H30NO</b>	2 x 15A/ 30 A total sum
	<b>RN1F12V30</b>		<b>RN1S23H30PO</b>	<b>RN2F12I30</b>
	<b>RN1F23I30</b>		<b>RN1S40H30NO</b>	<b>RN2F12V30</b>
	<b>RN1F23V30</b>		<b>RN1S40H30PO</b>	<b>RN2F23I30</b>
	<b>RN1F48I30</b>		<b>RN1S48H30NO</b>	<b>RN2F23V30</b>
	<b>RN1F48V30</b>		<b>RN1S48H30PO</b>	<b>RN2F48I30</b>
50 A	<b>RN1F12I50</b>	50 A	<b>RN1S23H50NO</b>	<b>RN2F48V30</b>
	<b>RN1F12V50</b>		<b>RN1S23H50PO</b>	2x25A/ 50 A total sum
	<b>RN1F23I50</b>		<b>RN1S40H50NO</b>	<b>RN2F12I50</b>
	<b>RN1F23V50</b>		<b>RN1S40H50PO</b>	<b>RN2F12V50</b>
	<b>RN1F48I50</b>		<b>RN1S48H50NO</b>	<b>RN2F23I50</b>
	<b>RN1F48V50</b>		<b>RN1S48H50PO</b>	<b>RN2F23V50</b>
				<b>RN2F48I50</b>
				<b>RN2F48V50</b>

\* Other options available on request: Active low control input and normally closed alarm output.



# Solid state contactors, 2/3-phase

Ready for use design - DIN rail mounting, AC output switching

Types	<b>RJ2A MIDI</b> 2 + 1 poles	<b>RJ2A POWER</b> 2 + 1 poles	<b>RJ3A MIDI**</b> 3 poles	<b>RJ3A POWER</b> 3 poles
Semiconductor contactors with integrated heatsink. AC operating frequency range 45-65 Hz. Rated isolation voltage $\geq 4000$ Vrms.				
Dimensions HxWxD (mm)	103 x 45 x 103	103 x 90 x 103	103 x 45 x 103 122 x 45 x 103 [with fan]	103 x 90 x 103
Features	2 Pole switching 1 Pole direct 1 Control input	2 Pole switching 1 Pole direct 1 Control input	3 Pole switching 1 Control input	3 Pole switching 1 Control input

## Control specifications

Control input range	5-32 VDC [RJ2A..D..] 24-275 VAC/ [RJ2A..A..] 24-190 VDC	5-32 VDC [RJ2A..D..] 24-275 VAC/ [RJ2A..A..] 24-190 VDC	5-32 VDC [RJ3A..D..] 24-275 VAC/ [RJ3A..A..] 24-190 VDC	5-32 VDC [RJ3A..D..] 24-275 VAC/ [RJ3A..A..] 24-190 VDC
Max. input current	24 mA	24 mA	24 mA	24 mA

## Output specifications

Rated operational current				
AC 51 @ Ta=25°C	3 x 25 A	3 x 32 A	3 x 20 A/ 3 x 32 A [with fan]	3 x 25 A
AC 53a @ Ta=25°C	3 x 15 A	3 x 15 A	3 x 15 A	3 x 15 A
Min. operational current	250 mArms	250 mArms	250 mArms	250 mArms
Non-repet. surge current (t=10 ms)	600 A <sub>p</sub>	600 A <sub>p</sub>	600 A <sub>p</sub>	600 A <sub>p</sub>
Off-state leakage current	< 3 mArms	< 3 mArms	< 3 mArms	< 3 mArms
I <sup>2</sup> t for fusing (t=10 ms)	1800 A <sup>2</sup> s	1800 A <sup>2</sup> s	18000 A <sup>2</sup> s	18000 A <sup>2</sup> s
Critical dV/dt off-state	500 V/μs	500 V/μs	500 V/μs	500 V/μs

## General specifications

Operational voltage range	24 -280 Vrms [RJ2A22..] 40 -660 Vrms [RJ2A60..]	24-280 Vrms [RJ2A22..] 40-660 Vrms [RJ2A60..]	24-280 Vrms [RJ3A22..] 40-660 Vrms [RJ3A60..]	24-280 Vrms [RJ3A22..] 40-660 Vrms [RJ3A60..]
Blocking voltage	650 V <sub>p</sub> [RJ2A22..] 1200 V <sub>p</sub> [RJ2A60..]	650 V <sub>p</sub> [RJ2A22..] 1200 V <sub>p</sub> [RJ2A60..]	650 V <sub>p</sub> [RJ3A22..] 1200 V <sub>p</sub> [RJ3A60..]	650 V <sub>p</sub> [RJ3A22..] 1200 V <sub>p</sub> [RJ3A60..]
Power factor	$\geq 0.5$	$\geq 0.5$	$\geq 0.5$	$\geq 0.5$
Operating temperature	-30° to +70°C	-30° to +70°C	-30° to +70°C	-30° to +70°C
Storage temperature	-40° to +80°C	-40° to +80°C	-40° to +100°C	-40° to +100°C
Terminals	Box clamp	Box clamp	Box clamp	Box clamp
Approvals/Marks	UL - CSA - CE	UL - CSA - CE	UL - CSA - CE	UL - CSA - CE

## References



	3 x 25 A	3 x 32 A	3 x 20 A	3 x 25 A
AC control / 220 Vrms	<b>RJ2A22A25E</b>	<b>RJ2A22A32E</b>	<b>RJ3A22A20E</b>	<b>RJ3A22A25E</b>
DC control / 220 Vrms	<b>RJ2A22D25</b>	<b>RJ2A22D32</b>	<b>RJ3A22D20</b>	<b>RJ3A22D25</b>
AC control / 600 Vrms	<b>RJ2A60A25E</b>	<b>RJ2A60A32E</b>	<b>RJ3A60A25E</b>	<b>RJ3A60A25E</b>
DC control / 600 Vrms	<b>RJ2A60D25</b>	<b>RJ2A60D32</b>	<b>RJ3A60D25</b> 3 x 32 A [with fan]	<b>RJ3A60D25</b>
AC control / 220 Vrms			<b>RJ3A22A32EP*</b>	
DC control / 220 Vrms			<b>RJ3A22D32EP*</b>	
AC control / 600 Vrms			<b>RJ3A60A32EP*</b>	
DC control / 600 Vrms			<b>RJ3A60D32EP*</b>	

\* With integrated fan and over-temperature protection.

\*\* Other options available on request: over temperature protection (add suffix "P"). DC control version with integrated overtemperature protection available with type "E" terminals only.



# Solid state contactors for motor switching, 3-phase

Ready for use design - DIN rail mounting

Types	REC2B	REC3B	REC2R
Semiconductor contactors with integrated heatsink. AC operating frequency range 45-65 Hz. Rated isolation voltage $\geq 4000$ Vrms.			
Dimensions HxWxD (mm)	105 x 45 x 99.4	105 x 45 x 99.4	105 x 45 x 99.4
Features	2ph switching Electronic motor contactor	3ph switching Electronic motor contactor	2ph switching Electronic motor contactor for reversing
<b>Control specifications</b>			
Control input range	15-32 VDC [REC..D] 90-253 VAC [REC..A]	15-32 VDC [REC..D] 90-253 VAC [REC..A]	15-32 VDC [REC..D] 90-253 VAC [REC..A]
Max. input current	10 mADC [REC..D] 15 mAAC [REC..A]	10 mADC [REC..D] 15 mAAC [REC..A]	10 mADC [REC..D] 15 mAAC [REC..A]
<b>Output specifications</b>			
Rated operational current AC53a @ Ta= 40°C, 400 VAC	6.2 AAC [REC2B..20] 7.6 AAC [REC2B..30] 9.2 AAC [REC2B..40]	5.8 AAC [REC3B.20] 5.8 AAC [REC3B.21] 7.6 AAC [REC3B.30]	6.2 AAC [REC2R..20] 7.6 AAC [REC2R..30]
Motor Rating @ 400 VAC UL508/IEC60947-4-2 @40°C	3HP / 2.2 kW [REC2B.20] 3HP / 3.0 kW [REC2B.30] 3HP / 4.0 kW [REC2B.40]	2HP / 2.2 kW [REC3B.20] 2HP / 2.2 kW [REC3B.21] 3HP / 3.0 kW [REC3B.30]	3HP / 2.2 kW [REC2R.20] 3HP / 3.0 kW [REC2R.30]
Min. operational current	150 mA [RECB.20]	150 mA [REC3B..20]	150 mA [REC2R..20]
Non-repet. surge current (I <sub>tsm</sub> ) (t=10 ms)	325 A <sub>p</sub> [REC2B.20] 600 A <sub>p</sub> [REC2B.30] 800 A <sub>p</sub> [REC2B.40]	325 A <sub>p</sub> [REC3B48..20] 600 A <sub>p</sub> [REC3B60..20] 600 A <sub>p</sub> [REC3..21] 800 A <sub>p</sub> [REC3..30]	600 A <sub>p</sub>
Off-state leakage current	< 3 mAAC	< 3 mAAC	< 3 mAAC
I <sup>2</sup> t for fusing (t=10 ms)	525 A <sup>2</sup> s [REC2.20] 525 A <sup>2</sup> s [REC2.48..30] 1800 A <sup>2</sup> s [REC2.60..30] 3200 A <sup>2</sup> s [REC2.40]	525A <sup>2</sup> s [REC3B48..20] 1800 A <sup>2</sup> s [REC3B60..20] 1800 A <sup>2</sup> s [REC3..21] 3200 A <sup>2</sup> s [REC3.40]	1800 A <sup>2</sup> s
Critical dV/dt off-state	1000 V/μs	1000 V/μs	1000 V/μs
<b>General specifications</b>			
Operational voltage range	48 - 530 VAC [REC..48..] 48 - 600 VAC [REC..60..]	48 - 530 VAC [REC..48..] 48 - 600 VAC [REC..60..]	48 - 530 VAC [REC..48..] 48 - 600 VAC [REC..60..]
Blocking voltage	1200 V <sub>p</sub> [REC..48..] 1600 V <sub>p</sub> [REC..60..]	1200 V <sub>p</sub> [REC..48..] 1600 V <sub>p</sub> [REC..60..]	1200 V <sub>p</sub> [REC..48..] 1600 V <sub>p</sub> [REC..60..]
Power factor	$\geq 0.5$ at rated voltage	$\geq 0.5$ at rated voltage	$\geq 0.5$ at rated voltage
Operating temperature	-25°C to +60°C	-25°C to +60°C	-25°C to +60°C
Terminals	input screw/spring, output screw	input screw/spring, output screw	input screw/spring, output screw
Approvals/Marks	CE - cULus listed	CE - cULus listed	CE - cULus listed
<b>References</b>			
	2.2 kW	2.2 kW	2.2 kW
	<b>REC2B48D20GKE</b>	<b>REC3B48D20GKE</b>	<b>REC2R48D20GKE</b>
	<b>REC2B48A20GKE</b>	<b>REC3B48A20GKE</b>	<b>REC2R48A20GKE</b>
	3.0 kW	<b>REC3B60D20GKE</b>	3.0 kW
	<b>REC2B48D30GKE</b>	<b>REC3B60A20GKE</b>	<b>REC2R48D30GKE</b>
	<b>REC2B48A30GKE</b>	2.2 kW (high I <sub>tsm</sub> )	<b>REC2R48A30GKE</b>
	<b>REC2B60D30GKE</b>	<b>REC3B48D21GKE</b>	<b>REC2R60D30GKE</b>
	<b>REC2B60A30GKE</b>	3.0 kW	<b>REC2R60A30GKE</b>
	4.0 kW	<b>REC3B48D30GKE</b>	
	<b>REC2B48D40GKE</b>	<b>REC3B48A30GKE</b>	
	<b>REC2B48A40GKE</b>		

# Soft starters

## Motor control - Soft start and stop

Types	RSDR	RSQK	RSXK
			
	Soft starting and soft stopping of 3-phase induction motors. High Inertia loads (Trip Class 30) starting.		
Features	Rotary knobs to adjust start/stop/initial torque parameters. Internally bypassed. Ramp-up/Ramp-down time up to 30 s	Energy optimising soft starter. Keypad control with LCD monitoring menu. In delta compatibility. Automatic application setup. Optional modbus and Remote Keypad operation. Adjustable Overload protection. Static load control.	Energy optimising soft starter. Keypad control with LCD monitoring menu. In delta compatibility. Automatic application setup. Optional modbus and Remote Keypad operation. Adjustable Overload protection.

### Control specifications

Control input range	24 VDC / 110 VAC (externally supplied)	115 VAC or 230 VAC	115 VAC or 230 VAC
Controlled phases	2	3	3

### Output specifications

Rated operational current	55/ 66/ 80/ 97/ 132/ 160/ 195/ 230/ 280/ 350/ 430/ 500	23/ 30/ 44/ 59/ 72/ 85/ 105/ 146/ 174/ 202/ 242/ 300/ 370/ 500/ 600/ 750/ 900/ 1100/ 1200/ 1400/ 1600/ 1800	22/ 29/ 35/ 41/ 55/ 66/ 80/ 97/ 132/ 160/ 195/ 230/ 280/ 382/ 430/ 540/ 610/ 690/ 850/ 950/ 1060/ 1150/ 1190/ 1346/ 1518/ 1673
Overload current profile @ 40°C	AC53b: 3-5:355	AC53a: 3-35:99-10 (RSQK...0023 to ...0202) AC53a: 3-35:60-3 (RSQK...0242 to ...0900) AC53a: 3-35:60-6 (RSQK...0400 to ...1200) AC53a: 3-30:60-3 (RSQK...1400 to ...1800)	AC53a: 3.5-12:75-5 (RSXK...0022 to ...0160) AC53a: 3.5-12:60-3 (RSXK...0195 to ...1673)
Number of starts per hour @40°C	10 for (light loads) 5 for (Heavy loads)	10 (RSQK...0023 to RSQK..0202) 3 (RSQK..0242 to RSQK..0900) 6 (RSQK..0400 to RSQK..1200) 3 (RSQK..1400 to RSQK..1800)	5 (RSXK..0022 to RSXK..0160) 3 (RSXK..0195 to RSXK..1673)
Assigned motor rating @ 40°C.	<b>RSDR40055B</b> (30 kW/42 HP)	<b>RSQK..023 - RSQK..072</b> (11kW/15HP - 37kW/54HP)	<b>RSXK..022 - RSXK..066</b> (11kW/15HP - 37kW/54HP)
	<b>RSDR40066B</b> (37 kW/54 HP)		
	<b>RSDR40080B</b> (45 kW/60 HP)	<b>RSQK..085 - RSQK..0202</b> (45kW/60HP - 110kW/175HP)	<b>RSXK..085 - RSXK..0195</b> (45kW/60HP - 110kW/175HP)
	<b>RSDR40097B</b> (55 kW/75 HP)		
	<b>RSDR40132B</b> (75 kW/110 HP)	<b>RSQK..0242 - RSQK..0500</b> (132kW/200HP - 250kW/300HP)	<b>RSXK..0230 - RSXK..0430</b> (132kW/200HP - 250kW/300HP)
	<b>RSDR40160B</b> (90 kW/130 HP)		
	<b>RSDR40195B</b> (110 kW/160 HP)	<b>RSQK..0600 - RSQK..1100</b> (320kW/375HP - 630kW/750HP)	<b>RSXK..0540- RSXK..1150</b> (315kW/375HP - 630kW/820HP)
	<b>RSDR40230B</b> (132 kW/190 HP)		
	<b>RSDR40280B</b> (160 kW/230 HP)	<b>RSQK..1200 - RSQK..1800</b> (710 kW/900HP - 1050kW/1400HP)	<b>RSXK..1190 - RSXK...1673</b> (710kW/900HP - 1050kW/1400HP)
	<b>RSDR40350B</b> (200 kW/290 HP)		
<b>RSDR40430B</b> (250 kW/350HP)			
<b>RSDR40500B</b> (280 kW/400 HP)	*For more details see datasheet	*For more details see datasheet	

### General specifications

Operational voltage	230 - 460 VAC (-15%, +10%)	230 - 460 VAC (-15%, +10%) [RSQK40...] 400 - 575 VAC (-15%, +10%) [RSQK50...] 500 - 690 VAC (-15%, +10%) [RSQK60...]	230 - 460 VAC (-15%, +10%) [RSXK40...] 400 - 575 VAC (-15%, +10%) [RSXK50...] 500 - 690 VAC (-15%, +10%) [RSXK60...]
Internally bypassed	Yes	No	No
Operational frequency	50/60 Hz ±2 Hz	50/60 Hz ±2 Hz	50/60 Hz ±2 Hz
Ramp up/Ramp down	0.5 - 30 s / 0-30 s	1 - 255 s / 0 - 255 s	1 - 255 s / 0 - 255 s
Initial torque	30-100%	Automatic setup/ Current limit start	Automatic setup/ Current limit start
Operating temperature	0°C to +40°C (32°F to +104°F)	0°C to +40°C (32°F to +104°F)	0°C to +40°C (32°F to +104°F)
Storage temperature	-25°C to +60°C (-13°F to +140°F)	-25°C to +60°C (-13°F to +140°F)	-25°C to +60°C (-13°F to +140°F)
Wrong Ph. sequ. indication	No	Yes	Yes
Degree of Protection	IP 20 (up to 55 kW)	IP 20 (up to 500 kW)	IP 20 (up to 220 kW)
Approvals	CE - cULus*	CE - UL - cUL**	CE



\* RSDR40055B to RSDR40280B

\*\* Applicable to RSQK40... and RSQK50... up to 500kW

CARLO GAVAZZI Automation Components. Specifications are subject to change without notice. Illustrations are for example only.



# Soft starters

## Motor control - Soft start and stop

Types	RSHR Midi	RSHR	RSHR 3-Phase
Soft starting and stopping of 3-phase motors. Starting / stopping time and initial torque can be independently adjusted.			
Dimensions (mm)	126 x 45x 114	108.5 x 90 x 90	158.5 x 90 x 90
Features	Rotary knobs to adjust start/ stop/ torque parameters. Internally bypassed. Optional auxiliary relay for end of ramp (V21 option)	Wrong phase sequence detection Motor PTC protection. Device overtemperature protection	Three phase controlled. In Line or In Delta (6-wire) connection. Wrong Phase sequence detection. Motor PTC protection. Phase Loss Detection
<b>Control specifications</b>			
Control input range	24-110 VAC/DC & 110-480 VAC	24-550 VAC/DC (Option "C") 24-600 VAC/DC (Option "D")	24-550 VAC/DC (Option "C") 24-600 VAC/DC (Option "D")
Controlled phases	2	2	3
<b>Output specifications</b>			
Rated operational current			
AC 53b	6A [RSHR..06...] 12A [RSHR..12...] 18A [RSHR..18...]	25A [RSHR..25...] 38A [RSHR..38...] 45A [RSHR..45...]	25A [RSHR..25...] 32A [RSHR..32...]
Operational voltage	127/220VAC [RSHR22..] 230/400VAC [RSHR40..] 277/480VAC [RSHR48..] 346/600VAC [RSHR60..] 190-530VAC [RSHRM..]	127/220VAC [RSHR22..] 230/400VAC [RSHR40..] 277/480VAC [RSHR48..] 346/600VAC [RSHR60..]	127/220VAC [RSHR22..] 230/400VAC [RSHR40..] 277/480VAC [RSHR48..] 346/600VAC [RSHR60..] 220-480VAC [RSHRM ] 400-480VAC [RSHRM]
Overload current profile @ 40°C	6A:AC-53b:4-5:4 [RSHR..06... ] 12A:AC-53b:4-5:50 [RSHR..12...] 18A: AC-53b:4-5:50 [RSHR..18... ] 6A:AC-53b:4-5:3 [RSHRM06BV...] 12A: AC-53b:4-5:14 [RSHRM12BV..] 18A: AC-53b:4-5:62 [RSHRM18BV...]	25A: AC-53b:4-5:65 [RSHR..25...] 38A: AC-53b:4-5:85 [RSHR..38...] 45A: AC-53b:4-5:115 [RSHR..45...]	25A: AC-53a: 4-4:50-7 [RSHR2225.../RSHR4025...] 25A: AC-53a: 4-4:50-3 [RSHR4825.../RSHR6025.../RSHRM] 32A: AC-53a: 4-4:50-50 [RSHR..32...]
Number of starts per hour @40°C	250 [RSHR..06... ] 60 [RSHR..12... ] 60 [RSHR..18... ] 275 [RSHRM..06... ] 150 [RSHRM..12... ] 60 [RSHRM..18... ]	50 [RSHR..25...] 40 [RSHR..38...] 30 [RSHR..45...]	7 [RSHR2225.../RSHR4025...] 3 [RSHR4825.../RSHR6025.../RSHRM] 50 [RSHR..32...]
Assigned motor rating @ 60°C. (In Line connection)	RSHR..06... / RSHR..12... / RSHR..18... 220V 1.1kW(1.5HP)/3kW(3HP)/4kW(5HP) 400V 2.2kW(3HP)/5.5kW(7.5HP)/7.5kW(10HP) 480V 2.2kW(5HP)/5.5kW(7.5HP)/7.5kW(10HP) 600V 3kW(5HP)/7.5kW(10HP)/11kW(15HP)	RSHR..25... / RSHR..38... / RSHR..45... 5.5kW(10HP)/11kW(10HP)/11kW(15HP) 11kW(15HP)/18.5kW(20HP)/22kW(25HP) 15kW(20HP)/22kW(25HP)/30kW(30HP) 18.5kW(25HP)/22kW(30HP)/30kW(40HP)	In Line Connection/In Delta Connection 4kW(5HP) / 7.5kW(10HP) 7.5kW(10HP) / 11kW(15HP) 9kW(10HP) / 15kW(20HP) 11kW(15HP) / 22kW(25HP)
<b>General specifications</b>			
Internally bypassed	Yes	Yes	No
Operational frequency	50/60Hz ±10%	50/60Hz ±10%	50/60Hz ±10%
Ramp up/Ramp down	0.5-10s / 0.5-20s	1-10s / 1-20s	1-10s / 0-30s 0-1s / 0-1s [RSHR...V38]
Initial torque	0-85%	0-70%	0-70%
Operating temperature	-20°C to +60°C (-4°F to +140°F)	-20°C to +60°C (-4°F to +140°F)	-20°C to +60°C (-4°F to +140°F)
Storage temperature	-50°C to +85°C (-58°F to +185°F)	-50°C to +85°C (-58°F to +185°F)	-50°C to +85°C (-58°F to +185°F)
Wrong Phase sequence indication	No	Yes	Yes
Degree of Protection	IP 20	IP 20	IP 20
Approvals	CE - UL - cUL	CE - UL - CSA	CE - UL - cUL - CCC



# Soft starters

## Motor control - Soft start and stop

Types	RSHL	RSE-B
Soft starting and stopping of 3-phase motors. Current limiting (RSHL) or standard ramping/ initial torque settings (RSE-B)		
Dimensions (mm)	126 x 45 x 114	103 x 45 x 80
Features	Internally bypassed. Current Limit start. Optional auxiliary relay output (Option V22). Integrated Overload protection. Selectable preset profiles via rotary knob.	Compact Design. Rotary knobs to adjust start/stop and initial torque parameters.
<b>Control specifications</b>		
Control input range	24 - 550 VAC/DC	24 - 110 VAC/DC 110 - 480 VAC
Controlled phases	2	2
<b>Output specifications</b>		
Rated operational current		
AC 53b	2 A [RSHL..02...] 5 A [RSHL..05...] 12 A [RSHL..12...] 18 A [RSHL..18...]	3 A [RSE..03-B] 12 A [RSE..12-B]
Operational voltage	127/220 VAC [RSHL22.....] 230/400 VAC [RSHL48.....] 277/480 VAC [RSHL48.....] 346/600 VAC [RSHL60.....]	127/220 VAC [RSE22..-B] 230/400 VAC [RSE40..-B] 277/480 VAC [RSE48..-B] 346/600 VAC [RSE60..-B]
Overload current profile @ 40°C	2A: AC-53b:4-5:0 5A: AC-53b:4-5:2.4 12 A: AC-53b : 4-5 : 21 [RSHL2212../RSHL4812..] 12 A: AC-53b : 4-5 : 26 [RSHL6012..] 18 A: AC-53b : 4-5 : 62	3 A: AC-53b : 3-5 : 30 12 A: AC-53b : 3-5 : 180
Number of starts per hour @40°C	360 [RSHL..02...] 290 [RSHL..05...] 116 [RSHL2212../RSHL4812...] 100 [RSHL..12...]	70 [RSE..03-B] 11 [RSE..12-B]
Assigned motor rating	RSHL..02... / RSHL..05... / RSHL..12... / RSHL..18...	RSE..03-B/ RSE..12-B
@ 220 V	0.5kW(0.5HP)/1.1kW(1.5HP)/3kW(3HP)/4kW(5HP)	0.55kW/3.0kW
@ 400 V	0.75kW(0.75HP)/2.2kW(3HP)/5.5kW(7.5HP)/7.5kW(10HP)	1.1kW/5.5kW
@ 480 V	1.1kW(1HP)/2.2kW(3HP)/5.5kW(7.5HP)/7.5kW(10HP)	1.5kW/5.75kW
@ 600 V	1.1kW(1HP)/3kW(5HP)/7.5kW(10HP)/11kW(15HP)	2.2kW/5.5kW
<b>General specifications</b>		
Internally bypassed	Yes	Yes
Operational frequency	50/60 Hz ±10%	50/60 Hz ±10%
Ramp up/Ramp down	Depends on profile selection.	0.5-7.5 s / 0.5 s -10 s
Initial torque	Depends on profile selection.	5-70%
Operating temperature	-20°C to +60°C (-4°F to +140°F)	-20°C to +50°C (-4°F to +122°F)
Storage temperature	-50°C to +85°C (-58°F to +185°F)	-50°C to +85°C (-58°F to +185°F)
Wrong Phase sequence indication	Yes	No
Degree of Protection	IP 20	IP 20
Approvals	CE - UL - cUL	CE - UL - CSA

# Soft starters

## HVAC Compressor soft starters

Types	RSBS	RSBT	RSBD & RSBT (120mm)
Soft starting of 1-Phase (RSBS) and 3-phase (RSBT) scroll compressors			
Dimensions (mm)	60.4* x 137 x 81.4	75 x 45 x 125 [RSBT...V10/V50] 81 x 45 x 125 [RSBT...V11/V51] 97.5 x 45 x 125 [RSBT...V21/V61]	150 x 120 x 170
Features	Internally bypassed Current Limit start Optional auxiliary relay output (Option V22)	Three Phase controlled, internally bypassed Auto-adapt function for reduction of inrush current (Patented). Optional auxiliary relay output for alarms (RFPMV00 accessory or Option V51/V61)	Patented Auto-adaptive algorithm Two - (RSBD) and Three phase (RSBT) Controlled versions Internally bypassed 2 Output relays for alarms and top of ramp indication
<b>Control specifications</b>			
Control input range	230 VAC	110 - 400 VAC	24VAC/DC & 110-400VAC
Controlled phases	1	3	2 [RSBD48..CV.] 3 [RSBT48..CV.]
<b>Output specifications</b>			
Rated operational current	25 A [RSBS2325..] 32 A [RSBS2332..]	16 A [RSBT..16..] 25 A [RSBT..25..] 32 A [RSBT..32..]	55A [RSB.4855CV..] 70A [RSB.4870CV..] 95A [RSB.4895CV..]
Operational voltage	230 VAC (-15%, + 10%)	220 VAC (-15%, + 10%) [RSBT22..] 400 VAC (-15%, + 10%) [RSBT40..]	220 - 480VAC (-15%, +10%)
Overload current profile @ 40°C	25 A: AC-53b: 1.6 - 1:60 [RSBS2325..] 32 A: AC-53b: 1.4 - 1:60 [RSBS2332..]	16 A: AC-53b : 2.5 - 1 : 60 25 A: AC-53b : 3.6 - 1 : 60 32 A: AC-53b : 3.4 - 1 : 60	55A: AC-53b: 3.5 - 1 : 299 70A: AC-53b: 3.5 - 1 : 299 95A: AC-53b: 3.5 - 1 : 299
Number of starts per hour	12 (evenly distributed)	12 (evenly distributed)	12 (evenly distributed)
Assigned compressor rating	RSBS2325... / RSBS2332...	RSBT..16... / RSBT..25... / RSBT..32...	RSB.4855CV../ RSB.4870CV../ RSB.4895CV..
@ 220 V	N/A	4.0 kW (5 Hp) / 5.5 kW (7.5 Hp)/ 9.0 kW (10 Hp)	15kW (20 HP)/ 20kW (25 HP)/ 22kW (30HP)
@ 230 V	3.7 kW (5 HP) / 4 kW (5 HP)	N/A	15kW (20 HP)/ 20kW (25 HP)/ 22kW (30HP)
@ 400 V	N/A	7.5 kW (7.5 Hp)/11.0 kW (10 Hp)/15.0 kW (15 Hp)	22kW (30HP)/ 30kW (40HP)/ 45kW (50HP)
@ 480 V	N/A	N/A	30kW (40HP)/ 37kW (50HP)/ 55kW (75HP)
<b>General specifications</b>			
Internally bypassed	Yes	Yes	Yes
Operational frequency	50/60 Hz ±10%	50/60 Hz ±10%	50/60Hz +/- 10Hz
Ramp up/Ramp down	< 600ms/ 0s	< 600ms/ 0s	<1s/ 0s
Default Current limit	40 Arms [RSBS2325..V2..] 45 Arms [RSBS2332..V2..]	40 Arms [RSBT..16..] 90 Arms [RSBT..25..] 110 Arms [RSBT..32..]	192.5 Arms [RSB.4855CV..] 245.0 Arms [RSB.4870CV..] 332.5 Arms [RSB.4895CV..]
Operating temperature	-20° to +65°C (-4° to +149°F)	-20°C to +60°C (-4°F to +140°F) [RSBT..16EV..] -20°C to +55°C (-4°F to +131°F) [RSBT..25EV..] -20°C to +50°C (-4°F to +122°F) [RSBT..32EV..]	-20° to +60°C (-4° to +140°F)
Storage temperature	-30° to +70°C (-22° to +158°F)	-40°C to +85°C (-40°F to +185°F)	-40°C to +85°C (-40°F to +185°F)
Wrong Phase sequence indication	N/A	Yes	Yes
Degree of Protection	IP 20	IP 20	IP 20 (Housing) IP 10 (Terminals)
Approvals	CE - UL - cUL	CE - UL** - cUL**	CE - UL - cUL

\* For RSBS23...V22..., auxiliary terminal is 10.5mm protruding.

\*\* For options V50/ V51/ V61.

# Soft starters

## Motor control - Soft start and stop

## Reversing

Types	RSC..HD+RSO..	RSC..AA..+RSO...	RR2A
Soft starting and stopping of 3-phase motors (RSC...+RSO...). Phase angle control of 3-phase heaters (RSC.AA..+RSO). Reversing (RR..).			

Dimensions (mm)	65 x 103 x 74	65 x 103 x 74	41 x 103 x 74
Features	Output for external bypass contactor	User controlled analogue input	Reversing with interlock, optoisolation

### Control specifications

Control input range	10-32 VDC	0-20 mA (A-input) 4-20 mA (B-input)	10-40 VDC
Max. input current	1 mA	20 mA	20 mA
Control supply	10 - 32 VDC	10 - 32 VDC	
Max. supply current	180 mA	180 mA	

### Output specifications

Rated operational current			
AC 51a	16Arms [RSO..10] 25Arms [RSO..25] 50Arms [RSO..50] 90Arms [RSO..90] 110Arms [RSO..110]	16Arms [RSO..10] 25Arms [RSO..25] 50Arms [RSO..50] 90Arms [RSO..90] 110Arms [RSO..110]	
AC 53a	5 Arms [RSO..25] 15 Arms [RSO..50] 30 Arms [RSO..90] 40 Arms [RSO..110]	5 Arms [RSO..25] 15 Arms [RSO..50] 30 Arms [RSO..90] 40 Arms [RSO..110]	5 Arms [RR2A40D150/RR2A48D220] 11 Arms [RR2A40D400/RR2A48D550]
Overload current profile			5A: AC-53a : 6-6 : 100-60 11A: AC-53a : 8-3 : 100-40 **
Operational voltage	150-250 Vrms [RSO22..] 220-420 Vrms [RSO40..] 400-510 Vrms [RSO48..] 400-625 Vrms [RSO60..]	150-250 Vrms [RSO22..] 220-420 Vrms [RSO40..] 400-510 Vrms [RSO48..] 400-625 Vrms [RSO60..]	400 Vrms [RR2A40D...] 480 Vrms [RR2A48D...]

### General specifications

Ramp up / Ramp down	0.5-30 s / 0.5-30 s	User controlled	2-pole change-over, built-in transient overvolt. protect, interlocking reversing, LED status indication
Initial torque	10-75%	User controlled	
Bypass contactor supply	Vcc-8 VDC @ 150 mA max.		
Connections	Screw type with clamp	Screw type with clamp	Screw type with clamp
Operating temperature	-20°C to +70°C	-20°C to +70°C	-20°C to +80°C
Storage temperature	-40°C to +100°C	-40°C to +100°C	-40°C to +100°C
Approvals/Marks	CE - UL - CSA	CE - UL - CSA	CE - UL - cUL

### References

Control module	Control module	5 A
<b>RSC-HD0M60</b>	<b>RSC-AAM60</b>	<b>RR2A40D150</b> (1.5 kW)
Output module: 400 VAC	Output module: 400 VAC	<b>RR2A40D400</b> (4.0 kW)
25 A: <b>RSO4025</b> (4 kW*)	25 A: <b>RSO4025</b> (4 kW*)	11 A
50 A: <b>RSO4050</b> (11 kW*)	50 A: <b>RSO4050</b> (11 kW*)	<b>RR2A48D220</b> (2.2 kW)
90 A: <b>RSO4090</b> (15 kW*)	90 A: <b>RSO4090</b> (15 kW*)	<b>RR2A48D550</b> (5.5 kW)
110 A: <b>RSO40110</b> (22 kW*)	110 A: <b>RSO40110</b> (22 kW*)	



\* Output module can be 200, 400, 480, 600 VAC

\* Correct heatsink assembly required. For further details please consult datasheet.

\*\* Applicable when device is mounted to heatsink type RHS301

# Solid state relays accessories

## Heatsink assemblies for solid state relays



Types	RHS100	RHS45C	RHS45B
			
Dimensions HxWxD(mm)	82 x 45 x 49 (SSR not included)	103 x 45 x 55 (SSR not included)	103 x 45 x 81 (SSR not included)
Description	Heatsink for 1-phase RA, RD, RM, RAM, RS series. Heatsink assembly* with DIN-rail adaptor*	Heatsink for 1-phase RA, RD, RM, RAM, RS series Heatsink assembly* with DIN-rail adaptor. A fan 24VDC (RHSF40-24) may be mounted.	Heatsink for 1-phase RA, RD, RM, RAM, RS series Heatsink assembly* with DIN-rail adaptor. A fan 24VDC (RHSF40-24) may be mounted.

### Thermal resistance

without fan	3.0 K/W	2.7 K/W	2.0 K/W
with fan	Not available	1.25 K/W	1.2 K/W

### Selection guide for heatsink assemblies

without fan	R.....H0	R.....H15	R.....H5
with fan		upon request	upon request



Types	RHS90A	RHS37A	RHS320
			
Dimensions HxWxD(mm)	103 x 90 x 80 (SSR not included)	106 x 17.8 x 52.5 (SSR not included)	100 x 240 x 93 (SSR not included)
Description	Heatsink for 1-phase RA, RD, RM, RAM, RS series Heatsink assembly* with DIN-rail adaptor. A fan 24VDC (RHSF40-24) may be mounted.	Heatsink for 1-phase RG series Heatsink assembly* with DIN-rail adaptor.	Heatsink for 1-phase and 3-phase SSRs Heatsink assembly* for panel mounting.

### Thermal resistance

without fan	1.35 K/W	3.9 K/W	0.4 K/W
with fan	0.45 K/W	Not Available	Not Available

### Selection guide for heatsink assemblies

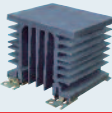
without fan	R.....H16	R.....H51	R.....H13
with fan	R.....H19		

Types	RHS300	RHS112A	RHS301
			
Dimensions HxWxD(mm)	82 x 105 x 60 (SSR not included)	103 x 112 x 80 (SSR not included)	83 x 118 x 96 (SSR not included)
Description	Heatsink suited for 3 phase SSRs. Heatsink assembly* with DIN-rail adaptor.	Heatsink for 1-phase and 3-phase SSRs. Heatsink assembly* with DIN-rail adaptor. A fan 24VDC (RHSF60-24) may be mounted.	Heatsink for 1-phase and 3-phase SSRs. Heatsink assembly* with DIN-rail adaptor. A fan (RHS301F115, RHS301F230) may be mounted.

### Thermal resistance

without fan	5.0 K/W	1.1 K/W	0.8 K/W
with fan	Not available	0.4 K/W	0.25 K/W

### Selection guide for heatsink assemblies



without fan	R.....H1	R.....H17	R.....H2
with fan		R.....H18	R.....H10 [115VAC fan] R.....H12 [230VAC fan]

\* Heatsink assembly includes mounting screws and thermal paste for semiconductor device.



# Solid state relays accessories

## General accessories

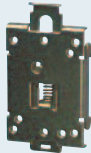
Types	RPM1	RPM1P	RPM2	DIN-rail adaptor
				
Dimensions HxWxD(mm)	84 x 12.5 x 42	84 x 12.5 x 42	82 x 25 x 39	81 x 44 x 13.5
Description	Din-rail adaptor for PCB relays. (Relay excluded)	Din-rail adaptor with sockets for plug-in PCB relays. (Relay excluded)	Din-rail adaptor for PCB relays with an operational voltage $\geq$ 230 V. (Relay excluded)	DIN-rail adaptor for heatsinks. Integrated in kits. RHS100, RHS300, RHS301.

## References

RPM1

RPM1P (no LED)  
RPM1PD (with LED)

RPM2

RHS00





## Selection guide for SSR assembly

RP...M1

RP...M1P (no LED)  
RP...M1PD (with LED)

RP...M2

R...H8

Types	RMIP20	BBR	RM terminal	RM terminal IP 20
				
Dimensions HxWxD(mm)	58 x 45 x 9	59 x 45 x 25.5	35 x 16.5 x 25	35 x 16.5 x 29
Description	Clip-on IP20 protection Cover for RAM, RM, RS.	Protection cover for RA and RD serie.	RM terminal adaptor for 16mm <sup>2</sup> and 35mm <sup>2</sup> cable	RM terminal adaptor for 35mm <sup>2</sup> cable, IP 20
Pack Quantity	20	25	10	10



## References

RMIP20

BBR

RM625FK (16mm<sup>2</sup>)  
RM635FK (35mm<sup>2</sup>)

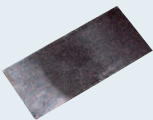
RM635FKP

Types	Thermal paste	Thermal pad RG	Thermal Pad RM, RA	Varistors
				
Dimensions HxWxD(mm)		34.6 x 14	35 x 42	
Description	Paste for relay mounting on heatsink	Thermal pad for RG. Thermal resistance: 0.8 K/W	RM, RS, RA thermal pad. Thermal resistance: 0.4 K/W	Solid State Relay protection against voltage transient (voltage surge).
Pack Quantity		10	50	10

## References

HTS02S

RGHT

KK071CUT

275 V: RV02 420 V: RV04  
510 V: RV05 625 V: RV06  
680 V: RV07

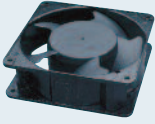

# Solid state relays accessories

## General accessories

Types	Fastons	Fan 24VDC
		
Dimensions HxWxD(mm)	4.8/6.3	40 x 40 x 20 (RHSF40) / 60 x 60 x 20 (RHSF60)
Description	Screw Faston terminals for RAM, RM, RS series	RHSF40-24 to be mounted with RHS45C, RHS45B RHSF60-24 to be mounted with RHS90A, RHS112A
Pack Quantity	20	

### References

4.8mm	6.3mm	
<b>RM48F0</b> (flat)	<b>RM63F0</b> (flat)	<b>RHSF40-24</b>
<b>RM48F4</b> (45° angle)	<b>RM63F4</b> (45° angle)	<b>RHSF60-24</b>

Types	Plug Terminals	Cables
		
Dimensions HxWxD(mm)		
Description	Spring pluggable terminals for RG 2.5mm <sup>2</sup> cables	Cable for RM1E...V and RA...S models with one-end terminated with a female plug for mounting on the SSR
Pack Quantity	10	1

### References

<b>RGM25</b>	<b>RCS3-100-1 [RM1E...V]</b>
	<b>RCSS5-200-1 [RA...S]</b>
	<b>RCS5-300-1 [RA...S]</b>

# Variable speed drives

## VariFlex<sup>2</sup> variable speed drives - RVEF series

## Accessories

Types	Size A	Size B	Braking unit
Drives, Inverters			

Dimensions (mm)	132 x 77 x 130.5	132 x 118 x 148	132 x 77 x 130.5
Features	Maximum overload of 150% of rated current for 60s, conforms to EN 61800-3 for the 2 <sup>nd</sup> environment, parameters accessible via keypad, knob and PC, optional RS485 serial communications, optional copy card for drive-to-drive parameter transfer and storage and optional remote keypad, built-in PID control.	Maximum overload of 150% of rated current for 60s, conforms to EN 61800-3 for the 2 <sup>nd</sup> environment, parameters accessible via keypad, knob and PC, optional RS485 serial communications, optional copy card for drive-to-drive parameter transfer and storage and optional remote keypad, built-in PID control.	External braking unit for RVEF frequency drives, with 240 VAC and 480 VAC inverter voltage. Applicable motor rated capacity up to 2.2 kW.

### Technical specifications

AC supply voltage	1-ph, 100-120 VAC; 1-ph, 200-240 VAC; 3-ph, 200-240 VAC;	1-ph, 200-240 VAC; 3-ph, 200-240 VAC; 3-ph, 380-480 VAC;	
AC supply frequency	50/60 Hz	50/60 Hz	
Output voltage	3-ph, 0-240 V	3-ph, 0-240 V 3-ph, 0-480 V	
Output frequency	0-200 Hz	0-200 Hz	
100% RMS output current	1.7 A [RVEFA...020] 3.1 A [RVEFA...040] 4.2 A [RVEFA...075]	7.5 A [RVEFB.20150] 10.5 A [RVEFB.20220] 2.3 A [RVEFB340075] 3.8 A [RVEFB340150] 5.2 A [RVEFB340220]	
Input displacement factor (cos φ)	> 0.97	> 0.97	

### General specifications

Operating temperature	-10°C to +50°C	-10°C to +50°C	-10°C to +50°C
Storage temperature	-20°C to +60°C	-20°C to +60°C	-20°C to +70°C
Degree of Protection	IP 20	IP 20	IP 20
Power connections	Screw terminals	Screw terminals	
Control connections	Screw terminals	Screw terminals	
Drive connections			Screw terminals
Mounting	DIN-rail or panel mounting	DIN-rail or panel mounting	DIN-rail or panel mounting
Integrated cooling fan	yes	yes	
Switching frequency	4 to 16 kHz	4 to 16 kHz	
Approvals	CE - cULus	CE - cULus	CE - cULus

### Braking unit

Rate discharge current	240 V : 7.5 A	480 V : 3 A
Max. discharge current	240 V : 15 A	480 V : 7.5 A

### References





110 VAC, 1-phase	<b>RVEFA110020</b> (0.20 kW-0.25 HP) <b>RVEFA110040</b> (0.40 kW-0.50 HP) <b>RVEFA110075</b> (0.75 kW-1.00 HP)		
230 VAC, 1-phase	<b>RVEFA120020(F)</b> (0.20 kW-0.25 HP) <b>RVEFA120040(F)</b> (0.40 kW-0.50 HP) <b>RVEFA120075(F)</b> (0.75 kW-1.00 HP)	<b>RVEFB120150(F)</b> (1.50 kW-2.00 HP) <b>RVEFB120220(F)</b> (2.20 kW-3.00 HP)	
230 VAC, 3-phase	<b>RVEFA320020</b> (0.20 kW-0.25 HP) <b>RVEFA320040</b> (0.40 kW-0.50 HP) <b>RVEFA320075</b> (0.75 kW-1.00 HP)	<b>RVEFB320150</b> (1.50 kW-2.00 HP) <b>RVEFB320220</b> (2.20 kW-3.00 HP)	<b>RVFTBU230</b>
480 VAC, 3-phase		<b>RVEFB340075(F)</b> (0.75 kW-1.00 HP) <b>RVEFB340150(F)</b> (1.50 kW-2.00 HP) <b>RVEFB340220(F)</b> (2.20 kW-3.00 HP)	<b>RVFTBU480</b>

(F): equipped with built-in filter

CARLO GAVAZZI Automation Components. Specifications are subject to change without notice. Illustrations are for example only.

# Variable speed drives

## VariFlex<sup>2</sup> variable speed drives - RVDF series

Types	Size A IP20	Size B IP20	Size A IP65	Size B IP65
Drives, Inverters				
Dimensions (mm)	132 x 72 x 118	140 x 118 x 171	205 x 134 x 174	295 x 232 x 181
Features	Maximum overload of 150% for 60 s, conforms to EN61800-3 for the 2 <sup>nd</sup> environment. Parameters settings by keypad.	Maximum overload of 150% for 60 s, conforms to EN61800-3 for the 2 <sup>nd</sup> environment. Parameters settings by keypad.	Maximum overload of 150% for 60 s, conforms to EN61800-3 for the 2 <sup>nd</sup> environment. Parameters settings by keypad. IP65 models with power switch, reverse/forward switch and potentiometer.	Maximum overload of 150% for 60 s, conforms to EN61800-3 for the 2 <sup>nd</sup> environment. Parameters settings by keypad. IP65 models with power switch, reverse/forward switch and potentiometer.

### Technical specifications

AC supply voltage	1-ph, 100-120 VAC; 1-ph, 200-240 VAC;	1-ph, 200-240 VAC; 3-ph, 200-240 VAC; 3-ph, 380-480 VAC	1-ph, 100-120 VAC; 1-ph, 200-240 VAC;	1-ph, 200-240 VAC; 3-ph, 200-240 VAC; 3-ph, 380-480 VAC
AC supply frequency	50/60 Hz	50/60 Hz	50/60 Hz	50/60 Hz
Output voltage	3-PH, 0-240 VAC	3-ph, 0-240 VAC; 3-ph, 0-480 VAC	3-PH, 0-240 VAC	3-ph, 0-240 VAC; 3-ph, 0-480 VAC
Output frequency	0-200 Hz	0-200 Hz	0-200 Hz	0-200 Hz
100% RMS output current	1.4 A [RV DFA...020] 2.3 A [RV DFA...040] 4.2 A [RV DFA...075]	7.5 A [RVDFB1...150] 10.5 A [RVDFB1...220] 2.3 A [RVDFB3...075] 3.8 A [RVDFB3...150] 5.2 A [RVDFB3...220]	1.4 A [RV DFA...020] 2.3 A [RV DFA...040] 4.2 A [RV DFA...075]	7.5 A [RVDFB1...150] 10.5 A [RVDFB1...220] 2.3 A [RVDFB3...075] 3.8 A [RVDFB3...150] 5.2 A [RVDFB3...220]
Input displacement factor (cos φ)	> 0.97	> 0.97	> 0.97	> 0.97

### General specifications



Operating temperature	-10°C to +50°C	-10°C to +50°C	-10°C to +50°C	-10°C to +50°C
Degree of Protection	IP 20	IP 20	IP 65	IP 65
Power connections	Screw terminals	Screw terminals	Screw terminals	Screw terminals
Control connections	Screw terminals	Screw terminals	Screw terminals	Screw terminals
Mounting	DIN-rail or panel mounting	DIN-rail or panel mounting	Panel mounting	Panel mounting
Integrated cooling fan	yes	yes	yes	yes
Switching frequency	4 to 16 kHz	4 to 16 kHz	4 to 16 kHz	4 to 16 kHz
Approvals	CE - cULus	CE - cULus	CE - cULus	CE - cULus

### References

100-120 VAC, 1-phase	<b>RV DFA10020</b> <b>RV DFA10040</b> <b>RV DFA10075</b>			<b>RVDFB120150FES</b> <b>RVDFB120220FES</b>
200-240 VAC, 1-phase		<b>RVDFB120150F</b> <b>RVDFB120220F</b>		
200-240 VAC, 3-phase	<b>RV DFA120020F</b> <b>RV DFA120040F</b> <b>RV DFA120075F</b>	<b>RVDFB120150F</b> <b>RVDFB120220F</b>	<b>RV DFA120020FES</b> <b>RV DFA120040FES</b> <b>RV DFA120075FES</b>	<b>RVDFB120150FES</b> <b>RVDFB120220FES</b>
380-480 VAC, 3-phase		<b>RVDFB340075F</b> <b>RVDFB340150F</b> <b>RVDFB340220F</b>		<b>RVDFB340075FES</b> <b>RVDFB340150FES</b> <b>RVDFB340220FES</b>

# Variable speed drives

## VariFlex<sup>2</sup> variable speed drives - RVCF series

Types	Size A	Size B	Size C
Drives, Inverters			
Dimensions (mm)	163 x 90 x 147	187.1 x 128 x 148	260 x 186 x 195
Features	Maximum overload of 150% of rated current for 60s, conforms to EN 61800-3 for the 2 <sup>nd</sup> environment, parameters accessible via keypad, knob and PC, optional serial communications, optional copy card for drive-to-drive parameter transfer and storage and optional keypad extension cable. Built-in PLC function and PID control.	Maximum overload of 150% of rated current for 60s, conforms to EN 61800-3 for the 2 <sup>nd</sup> environment, parameters accessible via keypad, knob and PC, optional serial communications, optional copy card for drive-to-drive parameter transfer and storage and optional keypad extension cable. Built-in PLC function and PID control.	Maximum overload of 150% of rated current for 60s, conforms to EN 61800-3 for the 2 <sup>nd</sup> environment, parameters accessible via keypad, knob and PC, optional serial communications, optional copy card for drive-to-drive parameter transfer and storage and optional keypad extension cable. Built-in PLC function and PID control.

### Technical specifications

AC supply voltage	1-ph, 200-240 VAC; 3-ph, 200-240 VAC; 3-ph, 380-480 VAC;	1-ph, 200-240 VAC; 3-ph, 200-240 VAC; 3-ph, 380-480 VAC;	3-ph, 200-240 VAC; 3-ph, 380-480 VAC;
AC supply frequency	50/60 Hz	50/60 Hz	50/60 Hz
Output voltage	3-ph, 0-240 V; 3-ph, 0-480 V;	3-ph, 0-240 V; 3-ph, 0-480 V;	3-ph, 0-240 V; 3-ph, 0-480 V;
Output frequency	0-650 Hz	0-650 Hz	0-650 Hz
100% RMS output current	3.1A [RVCFA1200040-RVCFA3200040] 4.5A [RVCFA1200075-RVCFA3200075] 7.5A [RVCFA3200150] 2.3A [RVCFA3400075] 3.8A [RVCFA3400150]	7.5A [RVCFB1200150] 10.5A [RVCFB1200220-RVCFB3200220] 17.5A [RVCFB3200370] 5.2A [RVCFB3400220] 8.8A [RVCFB3400370]	26A [RVCFC3200550] 35A [RVCFC3200750] 13A [RVCFC3400550] 17.5A [RVCFC3400750] 25A [RVCFC3401100]
Input displacement factor (cos φ)	> 0.97	> 0.97	> 0.97

### General specifications

Operating temperature	-10°C to +50°C	-10°C to +50°C	-10°C to +50°C
Storage temperature	-20°C to +60°C	-20°C to +60°C	-20°C to +60°C
Degree of Protection	IP 20	IP 20	IP 20
Power connections	Screw terminals	Screw terminals	Screw terminals
Control connections	Screw terminals	Screw terminals	Screw terminals
Mounting	DIN-rail or panel mounting	DIN-rail or panel mounting	Panel mounting
Integrated cooling fan	yes	yes	yes
Switching frequency	2 to 16 kHz	2 to 16 kHz	2 to 16 kHz
Approvals	CE - cULus	CE - cULus	CE - cULus



### References

220-240VAC, 1-phase	<b>RVCFA1200040(F)</b> (0.40 kW - 0.50 HP) <b>RVCFA1200075(F)</b> (0.75 kW - 1.00 HP)	<b>RVCFB1200150(F)</b> (1.50 kW - 2.00 HP) <b>RVCFB1200220(F)</b> (2.20 kW - 3.00 HP)	
220-240VAC, 3-phase	<b>RVCFA3200040</b> (0.40 kW - 0.50 HP) <b>RVCFA3200075</b> (0.75 kW - 1.00 HP) <b>RVCFA3200150</b> (1.50 kW - 2.00 HP)	<b>RVCFB3200220</b> (2.20 kW - 3.00 HP) <b>RVCFB3200370</b> (3.70 kW - 5.00 HP)	<b>RVCFC3200550</b> (5.50 kW - 7.50 HP) <b>RVCFC3200750</b> (7.50 kW - 10.0 HP)
380-480VAC, 3-phase	<b>RVCFA3400075(F)</b> (0.75 kW - 1.00 HP) <b>RVCFA3400150(F)</b> (1.50 kW - 2.00 HP)	<b>RVCFB3400220(F)</b> (2.20 kW - 3.00 HP) <b>RVCFB3400370(F)</b> (3.70 kW - 5.00 HP)	<b>RVCFC3400550(F)</b> (5.50 kW - 7.50 HP) <b>RVCFC3400750(F)</b> (7.50 kW - 10.0 HP) <b>RVCFC3401100(F)</b> (11.0 kW - 15.0 HP)





(F): equipped with built-in filter

# Variable speed drives

## VariFlex<sup>2</sup> variable speed drives - RVCF series





Types	Size D	Size E	Size F
Drives, Inverters			
Dimensions (mm)	360 x 265 x 247.5	553 x 269 x 303.6	653 x 308 x 308.6
Features	Maximum overload of 150% of rated current for 60s, conforms to EN 61800-3 for the 2 <sup>nd</sup> environment, parameters accessible via keypad, knob and PC, optional serial communications, optional copy card for drive-to-drive parameter transfer and storage and optional keypad extension cable. Built-in PLC function and PID control.	Maximum overload of 150% of rated current for 60s, conforms to EN 61800-3 for the 2 <sup>nd</sup> environment, parameters accessible via keypad, knob and PC, optional serial communications, optional copy card for drive-to-drive parameter transfer and storage and optional keypad extension cable. Built-in PLC function and PID control.	Maximum overload of 150% of rated current for 60s, conforms to EN 61800-3 for the 2 <sup>nd</sup> environment, parameters accessible via keypad, knob and PC, optional serial communications, optional copy card for drive-to-drive parameter transfer and storage and optional keypad extension cable. Built-in PLC function and PID control.
<b>Technical specifications</b>			
AC supply voltage	3-ph, 200-240 VAC; 3-ph, 380-480 VAC;	3-ph, 200-240 VAC; 3-ph, 380-480 VAC;	3-ph, 380-480 VAC;
AC supply frequency	50/60 Hz	50/60 Hz	50/60 Hz
Output voltage	3-ph, 0-240 V; 3-ph, 0-480 V;	3-ph, 0-240 V; 3-ph, 0-480 V;	3-ph, 0-480 V;
Output frequency	0-650 Hz	0-650 Hz	0-650 Hz
100% RMS output current	48 A [RVCFD3201100] 64 A [RVCFD3201500] 80 A [RVCFD3201850] 32 A [RVCFD3401500] 40 A [RVCFD3401850] 48 A [RVCFD3402200]	96 A [RVCFE3202200] 130 A [RVCFE3203000] 64 A [RVCFE3403000] 80 A [RVCFE3403700]	96 A [RVCF3404500] 128 A [RVCF3405500]
Input displacement factor (cos φ)	> 0.97	> 0.97	> 0.97
<b>General specifications</b>			
Operating temperature	-10°C to +50°C	-10°C to +50°C	-10°C to +50°C
Storage temperature	-20°C to +60°C	-20°C to +60°C	-20°C to +60°C
Degree of Protection	IP 20	IP 00	IP 00
Power connections	Screw terminals	Screw terminals	Screw terminals
Control connections	Screw terminals	Screw terminals	Screw terminals
Mounting	Panel mounting	Panel mounting	Panel mounting
Integrated cooling fan	yes	yes	yes
Switching frequency	2 to 16 kHz	2 to 16 kHz	2 to 16 kHz
Approvals	CE - cULus	CE - cULus	CE - cULus
<b>References</b>			
220-240VAC, 3-phase	<b>RVCFD3201100</b> (11.0 kW - 15.0 HP) <b>RVCFD3201500</b> (15.0 kW - 20.0 HP) <b>RVCFD3201850</b> (18.5 kW - 25.0 HP)	<b>RVCFE3202200</b> (22.0 kW - 30.0 HP) <b>RVCFE3203000</b> (30.0 kW - 40.0 HP)	
380-480VAC, 3-phase	<b>RVCFD3401500</b> (15.0 kW - 20.0 HP) <b>RVCFD3401850</b> (18.5 kW - 25.0 HP) <b>RVCFD3402200</b> (22.0 kW - 30.0 HP)	<b>RVCFE3403000</b> (30.0 kW - 40.0 HP) <b>RVCFE3403700</b> (37.0 kW - 50.0 HP)	<b>RVCF3404500</b> (45.0 kW - 60.0 HP) <b>RVCF3405500</b> (55.0 kW - 75.0 HP)

## Limit switches - Miniature type

Head Types	PO Plain plunger	PY Nylon roller plunger	P8 Cross nylon roller plunger	RT Ø14 Nylon roller lever
				
Dimensions (mm) WxHxD	35 x 60 x 16 1m PVC cable	35 x 70 x 16 1m PVC cable	35 x 70 x 16 1m PVC cable	35 x 92 x 29.5 1m PVC cable





### PS31M (metal\*) References contact block

Snap 1NO+1NC	⊖ PS31M-CS11PO-M00	PS31M-CS11PY-M00	PS31M-CS11P8-M00	PS31M-CS11RT-M00
Slow 1NO+1NC	⊖ PS31M-CT11PO-M00	PS31M-CT11PY-M00	PS31M-CT11P8-M00	PS31M-CT11RT-M00

				
Dimensions (mm) WxHxD	31.5 x 60 x 16 1m PVC cable	31.5 x 70 x 16 1m PVC cable	31.5 x 70 x 16 1m PVC cable	31.5 x 92 x 29.5 1m PVC cable





### PS21M (metal\*) References contact block

Snap 1NO+1NC	⊖ PS21M-CS11PO-M00	PS21M-CS11PY-M00	PS21M-CS11P8-M00	PS21M-CS11RT-M00
Slow 1NO+1NC	⊖ PS21M-CT11PO-M00	PS21M-CT11PY-M00	PS21M-CT11P8-M00	PS21M-CT11RT-M00

Head Types	Plain plunger with fixing nuts	Roller plunger with fixing nuts	Cross roller plunger with fixing nuts	R1 Adjustable lever with Ø18 nylon roller
				
Dimensions (mm) WxHxD	35 x 74 x 16 1m PVC cable	35 x 84.8 x 16 1m PVC cable	35 x 84.8 x 16 1m PVC cable	35 x 86...158 x 38.9 1m PVC cable

### PS31M (metal\*) References contact block

Snap 1NO+1NC	⊖ PS31M-CS11PO-M0L	PS31M-CS11PY-M0L	PS31M-CS11P8-M0L	PS31M-CS11RT-M0L
Slow 1NO+1NC	⊖ PS31M-CT11PO-M0L	PS31M-CT11PY-M0L	PS31M-CT11P8-M0L	PS31M-CT11RT-M0L

				
Dimensions (mm) WxHxD	31.5 x 74 x 16 1m PVC cable	31.5 x 84.8 x 16 1m PVC cable	31.5 x 84.8 x 16 1m PVC cable	31.5 x 86...158 x 38.9 1m PVC cable

### PS21M (metal\*) References contact block

Snap 1NO+1NC	⊖ PS21M-CS11PO-M0L	PS21M-CS11PY-M0L	PS21M-CS11P8-M0L	PS21M-CS11RT-M0L
Slow 1NO+1NC	⊖ PS21M-CT11PO-M0L	PS21M-CT11PY-M0L	PS21M-CT11P8-M0L	PS21M-CT11RT-M0L

### General specifications (for all types)

Mechanical life	>10 000 000 cycles	Rated thermal current (Ith)	10 A (IEC947-5-1)
Operating frequency	3600 cycles/h	Rated insulation voltage (Ui)	400 VAC (IEC947-5-1)
Operating Speed	1...1500 mm/s	Insulation resistance (500 VDC)	2 MΩ
Rated operating current (Ie)	1.5 A/230 V (Cat. AC15) 1.1 A/24 V (Cat. DC13)	Protection degree	IP 67
		Approvals	CE - UL (upon request)

\* Also available in thermoplastic (T type)

# Limit switches - Limit type

## Head types

**PO**  
Plain plunger

**PR**  
Roller plunger

**RH**  
Plastic roller plunger

**RT**  
Nylon roller lever



**Family: L**

	PS21	PS21	PS21	PS21
	Thermoplastic*	Thermoplastic*	Thermoplastic*	Thermoplastic*
Dimensions (mm) WxHxD	30.3 x 73 x 30	30.3 x 84 x 30	30.3 x 92 x 30	30.3 x 106 x 45

## References contact block

Snap 1NO+1NC	⊖	PS21L-PS11P0-T00	PS21L-PS11PR-T00	PS21L-PS11RH-T00	PS21L-PS11RT-T00
Slow 1NO+1NC	⊖	PS21L-PT11P0-T00	PS21L-PT11PR-T00	PS21L-PT11RH-T00	PS21L-PT11RT-T00
Slow Ov.**1NO+1NC	⊖	PS21L-PO11P0-T00	PS21L-PO11PR-T00	PS21L-PO11RH-T00	PS21L-PO11RT-T00
Slow 2NO		PS21L-PT20P0-T00	PS21L-PT20PR-T00	PS21L-PT20RH-T00	PS21L-PT20RT-T00
Slow 2NC	⊖	PS21L-PT02P0-T00	PS21L-PT02PR-T00	PS21L-PT02RH-T00	PS21L-PT02RT-T00
Snap 2NC	⊖	PS21L-PS02P0-T00	PS21L-PS02PR-T00	PS21L-PS02RH-T00	PS21L-PS02RT-T00

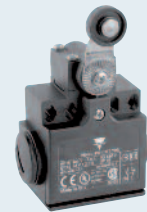
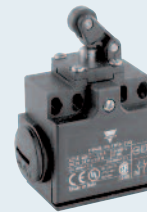

**Family: L**

	PS42	PS42	PS42	PS42
	Thermoplastic*	Thermoplastic*	Thermoplastic*	Thermoplastic*
Dimensions (mm) WxHxD	57 x 66 x 33	57 x 77 x 33	57 x 85 x 33	57 x 99 x 45

## References contact block

Snap 1NO+1NC	⊖	PS42L-PS11P0-T00	PS42L-PS11PR-T00	PS42L-PS11RH-T00	PS42L-PS11RT-T00
Slow 1NO+1NC	⊖	PS42L-PT11P0-T00	PS42L-PT11PR-T00	PS42L-PT11RH-T00	PS42L-PT11RT-T00
Slow Ov.**1NO+1NC	⊖	PS42L-PO11P0-T00	PS42L-PO11PR-T00	PS42L-PO11RH-T00	PS42L-PO11RT-T00
Slow 2NO		PS42L-PT20P0-T00	PS42L-PT20PR-T00	PS42L-PT20RH-T00	PS42L-PT20RT-T00
Slow 2NC	⊖	PS42L-PT02P0-T00	PS42L-PT02PR-T00	PS42L-PT02RH-T00	PS42L-PT02RT-T00
Snap 2NC	⊖	PS42L-PS02P0-T00	PS42L-PS02PR-T00	PS42L-PS02RH-T00	PS42L-PS02RT-T00

\* also available in metal (M type)

\*\* Ov. : overlapping travel paths



# Limit switches - Limit type

**Head types**      **W1** Adjustable lever with Ø50 rubber roller      **R1** Adjustable lever with Ø18 nylon roller      **BE** Ø18 nylon roller lever      **LW** Stainless steel spring cat whisker

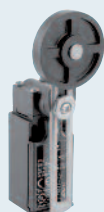

**Family: L**

	<b>PS21</b> Thermoplastic*	<b>PS21</b> Thermoplastic*	<b>PS21</b> Thermoplastic*	<b>PS21</b> Thermoplastic*
Dimensions (mm) WxHxD	30.3 x (126.5-186.5) x 52	30.3 x (98.5-170.5) x 45.5	30.3 x 114 x 33	30.3 x 188 x 30

## References contact block

Snap 1NO+1NC	⊖	<b>PS21L-PS11W1-T00</b>	<b>PS21L-PS11R1-T00</b>	<b>PS21L-PS11BE-T00</b>	<b>PS21L-PS11LW-T00</b>
Slow 1NO+1NC	⊖	<b>PS21L-PT11W1-T00</b>	<b>PS21L-PT11R1-T00</b>	<b>PS21L-PT11BE-T00</b>	<b>PS21L-PT11LW-T00</b>
Slow Ov.**1NO+1NC	⊖	<b>PS21L-PO11W1-T00</b>	<b>PS21L-PO11R1-T00</b>	<b>PS21L-PO11BE-T00</b>	<b>PS21L-PO11LW-T00</b>
Slow 2NO		<b>PS21L-PT20W1-T00</b>	<b>PS21L-PT20R1-T00</b>	<b>PS21L-PT20BE-T00</b>	<b>PS21L-PT20LW-T00</b>
Slow 2NC	⊖	<b>PS21L-PT02W1-T00</b>	<b>PS21L-PT02R1-T00</b>	<b>PS21L-PT02BE-T00</b>	<b>PS21L-PT02LW-T00</b>
Snap 2NC	⊖	<b>PS21L-PS02W1-T00</b>	<b>PS21L-PS02R1-T00</b>	<b>PS21L-PS02BE-T00</b>	<b>PS21L-PS02LW-T00</b>

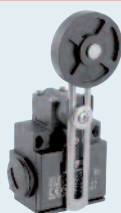

**Family: L**

	<b>PS42</b> Thermoplastic*	<b>PS42</b> Thermoplastic*	<b>PS42</b> Thermoplastic*	<b>PS42</b> Thermoplastic*
Dimensions (mm) WxHxD	57 x (118.5-177) x 33	57 x (91.5-163.5) x 33	57 x 107 x 33	57 x 181 x 45

## References contact block

Snap 1NO+1NC	⊖	<b>PS42L-PS11W1-T00</b>	<b>PS42L-PS11R1-T00</b>	<b>PS42L-PS11BE-T00</b>	<b>PS42L-PS11LW-T00</b>
Slow 1NO+1NC	⊖	<b>PS42L-PT11W1-T00</b>	<b>PS42L-PT11R1-T00</b>	<b>PS42L-PT11BE-T00</b>	<b>PS42L-PT11LW-T00</b>
Slow Ov.**1NO+1NC	⊖	<b>PS42L-PO11W1-T00</b>	<b>PS42L-PO11R1-T00</b>	<b>PS42L-PO11BE-T00</b>	<b>PS42L-PO11LW-T00</b>
Slow 2NO		<b>PS42L-PT20W1-T00</b>	<b>PS42L-PT20R1-T00</b>	<b>PS42L-PT20BE-T00</b>	<b>PS42L-PT20LW-T00</b>
Slow 2NC	⊖	<b>PS42L-PT02W1-T00</b>	<b>PS42L-PT02R1-T00</b>	<b>PS42L-PT02BE-T00</b>	<b>PS42L-PT02LW-T00</b>
Snap 2NC	⊖	<b>PS42L-PS02W1-T00</b>	<b>PS42L-PS02R1-T00</b>	<b>PS42L-PS02BE-T00</b>	<b>PS42L-PS02LW-T00</b>

## General specifications (for all types)

Degree of protection	IP 65 (plastic body) IP 66 (metal body)	Rated operational current	
Rated insulation voltage plastic body	(U <sub>i</sub> )	le/AC-15 230 VAC	3.1 A
according to IEC 60947-1 and EN 60947-1	500 V	le/AC-13 24 VDC	2.8 V
according to UL 508, CSA C22-2 n°14	A 600, Q 600	Electrical durability (according to IEC 60947-5-1 annex C)	
Rated insulation voltage metal body	(U <sub>i</sub> )	max. switching frequency Cycles/h	3600
according to IEC 60947-1 and EN 60947-1	400 V (PS21, PS42), 500 V (PS31, PS43)	load factor	0.5
according to UL 508, CSA C22-2 n°14	A 300, Q 300 (PS21, PS42) A 600, Q 600 (PS31, PS43)	Air temperature near the device	
Conventional enclosed thermal voltage (U <sub>imp</sub> )	6 kV	during operation	-25 to +70°C
		for storage	-30 to +80°C
		Approvals	CE - UL - CSA

\* also available in metal (M type)

\*\* Ov. : overlapping travel paths

# Limit switches - Limit type

## Head types

**PO**  
Plain plunger

**PR**  
Roller plunger

**RH**  
Plastic roller lever

**RT**  
Nylon roller lever



**Family: L**

	<b>PS43</b> Metal	<b>PS43</b> Metal	<b>PS43</b> Metal	<b>PS43</b> Metal
Dimensions (mm) WxHxD	66 x 102.5 x 43	66 x 115.5 x 43	67 x 129.5 x 43	66 x 128.5 x 61.5

## References contact block

Snap 1NO+1NC	⊖ PS43L-PS11P0-M00	PS43L-PS11PR-M00	PS43L-PS11RH-M00	PS43L-PS11RT-M00
Slow 1NO+1NC	⊖ PS43L-PT11P0-M00	PS43L-PT11PR-M00	PS43L-PT11RH-M00	PS43L-PT11RT-M00
Slow Ov.**1NO+1NC	⊖ PS43L-PO11P0-M00	PS43L-PO11PR-M00	PS43L-PO11RH-M00	PS43L-PO11RT-M00
Slow 2NO	PS43L-PT20P0-M00	PS43L-PT20PR-M00	PS43L-PT20RH-M00	PS43L-PT20RT-M00
Slow 2NC	⊖ PS43L-PT02P0-M00	PS43L-PT02PR-M00	PS43L-PT02RH-M00	PS43L-PT02RT-M00
Snap 2NC	⊖ PS43L-PS02P0-M00	PS43L-PS02PR-M00	PS43L-PS02RH-M00	PS43L-PS02RT-M00
Slow 1NO+2NC	⊖ PS43L-PT12P0-M00	PS43L-PT12PR-M00	PS43L-PT12RH-M00	PS43L-PT12RT-M00
Slow 2NO+1NC	⊖ PS43L-PT21P0-M00	PS43L-PT21PR-M00	PS43L-PT21RH-M00	PS43L-PT21RT-M00
Slow 3NC	⊖ PS43L-PT03P0-M00	PS43L-PT03PR-M00	PS43L-PT03RH-M00	PS43L-PT03RT-M00
Slow 3NO	PS43L-PT30P0-M00	PS43L-PT30PR-M00	PS43L-PT30RH-M00	PS43L-PT30RT-M00



**Family: L**

	<b>PS31</b> Thermoplastic*	<b>PS31</b> Thermoplastic*	<b>PS31</b> Thermoplastic*	<b>PS31</b> Thermoplastic*
Dimensions (mm) WxHxD	41 x 104 x 40.5	41 x 117 x 40.5	41 x 121 x 40.5	41 x 130 x 59

## References contact block

Snap 1NO+1NC	⊖ PS31L-PS11P0-T00	PS31L-PS11PR-T00	PS31L-PS11RH-T00	PS31L-PS11RT-T00
Slow 1NO+1NC	⊖ PS31L-PT11P0-T00	PS31L-PT11PR-T00	PS31L-PT11RH-T00	PS31L-PT11RT-T00
Slow Ov.**1NO+1NC	⊖ PS31L-PO11P0-T00	PS31L-PO11PR-T00	PS31L-PO11RH-T00	PS31L-PO11RT-T00
Slow 2NO	PS31L-PT20P0-T00	PS31L-PT20PR-T00	PS31L-PT20RH-T00	PS31L-PT20RT-T00
Slow 2NC	⊖ PS31L-PT02P0-T00	PS31L-PT02PR-T00	PS31L-PT02RH-T00	PS31L-PT02RT-T00
Snap 2NC	⊖ PS31L-PS02P0-T00	PS31L-PS02PR-T00	PS31L-PS02RH-T00	PS31L-PS02RT-T00
Slow 1NO+2NC	⊖ PS31L-PT12P0-T00	PS31L-PT12PR-T00	PS31L-PT12RH-T00	PS31L-PT12RT-T00
Slow 2NO+1NC	⊖ PS31L-PT21P0-T00	PS31L-PT21PR-T00	PS31L-PT21RH-T00	PS31L-PT21RT-T00
Slow 3NC	⊖ PS31L-PT03P0-T00	PS31L-PT03PR-T00	PS31L-PT03RH-T00	PS31L-PT03RT-T00
Slow 3NO	⊖ PS31L-PT30P0-T00	PS31L-PT30PR-T00	PS31L-PT30RH-T00	PS31L-PT30RT-T00

\* also available in metal (M type)

\*\* Ov. : overlapping travel paths

# Limit switches - Limit type

**Head types**      **W1** Adjustable lever with Ø50 rubber roller      **R1** Adjustable lever with Ø18 nylon roller      **BE** Ø18 nylon roller lever      **LW** Stainless steel spring cat whisker



**Family: L**

	<b>PS43</b> Metal	<b>PS43</b> Metal	<b>PS43</b> Metal	<b>PS43</b> Metal
Dimensions (mm) WxHxD	62 x (147.5-203.5) x 62.5	62 x (133.5-189.5) x 60	62 x 142.5 x 66	62 x 195,5 x 43

## References contact block

Snap 1NO+1NC	⊖	<b>PS43L-PS11W1-M00</b>	<b>PS43L-PS11R1-M00</b>	<b>PS43L-PS11W0-M00</b>	<b>PS43L-PS11LW-M00</b>
Slow 1NO+1NC	⊖	<b>PS43L-PT11W1-M00</b>	<b>PS43L-PT11R1-M00</b>	<b>PS43L-PT11W0-M00</b>	<b>PS43L-PT11LW-M00</b>
Slow Ov.**1NO+1NC	⊖	<b>PS43L-PO11W1-M00</b>	<b>PS43L-PO11R1-M00</b>	<b>PS43L-PO11W0-M00</b>	<b>PS43L-PO11LW-M00</b>
Slow 2NO		<b>PS43L-PT20W1-M00</b>	<b>PS43L-PT20R1-M00</b>	<b>PS43L-PT20W0-M00</b>	<b>PS43L-PT20LW-M00</b>
Slow 2NC	⊖	<b>PS43L-PT02W1-M00</b>	<b>PS43L-PT02R1-M00</b>	<b>PS43L-PT02W0-M00</b>	<b>PS43L-PT02LW-M00</b>
Snap 2NC	⊖	<b>PS43L-PS02W1-M00</b>	<b>PS43L-PS02R1-M00</b>	<b>PS43L-PS02W0-M00</b>	<b>PS43L-PS02LW-M00</b>
Slow 1NO+2NC	⊖	<b>PS43L-PT12W1-M00</b>	<b>PS43L-PT12R1-M00</b>	<b>PS43L-PT12W0-M00</b>	<b>PS43L-PT12LW-M00</b>
Slow 2NO+1NC	⊖	<b>PS43L-PT21W1-M00</b>	<b>PS43L-PT21R1-M00</b>	<b>PS43L-PT21W0-M00</b>	<b>PS43L-PT21LW-M00</b>
Slow 3NC	⊖	<b>PS43L-PT03W1-M00</b>	<b>PS43L-PT03R1-M00</b>	<b>PS43L-PT03W0-M00</b>	<b>PS43L-PT03LW-M00</b>
Slow 3NO		<b>PS43L-PT30W1-M00</b>	<b>PS43L-PT30R1-M00</b>	<b>PS43L-PT30W0-M00</b>	<b>PS43L-PT30LW-M00</b>

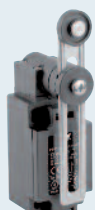
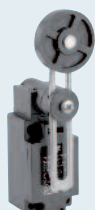

**Family: L**

	<b>PS31</b> Thermoplastic*	<b>PS31</b> Thermoplastic*	<b>PS31</b> Thermoplastic*	<b>PS31</b> Thermoplastic*
Dimensions (mm) WxHxD	50 x (149-205) x 65	41 x (135-191) x 60	50 x 144 x 64.5	41 x 195 x 40.5

## References contact block

Snap 1NO+1NC	⊖	<b>PS31L-PS11W1-T00</b>	<b>PS31L-PS11R1-T00</b>	<b>PS31L-PS11W0-T00</b>	<b>PS31L-PS11LW-T00</b>
Slow 1NO+1NC	⊖	<b>PS31L-PT11W1-T00</b>	<b>PS31L-PT11R1-T00</b>	<b>PS31L-PT11W0-T00</b>	<b>PS31L-PT11LW-T00</b>
Slow Ov.**1NO+1NC	⊖	<b>PS31L-PO11W1-T00</b>	<b>PS31L-PO11R1-T00</b>	<b>PS31L-PO11W0-T00</b>	<b>PS31L-PO11LW-T00</b>
Slow 2NO		<b>PS31L-PT20W1-T00</b>	<b>PS31L-PT20R1-T00</b>	<b>PS31L-PT20W0-T00</b>	<b>PS31L-PT20LW-T00</b>
Slow 2NC	⊖	<b>PS31L-PT02W1-T00</b>	<b>PS31L-PT02R1-T00</b>	<b>PS31L-PT02W0-T00</b>	<b>PS31L-PT02LW-T00</b>
Snap 2NC	⊖	<b>PS31L-PS02W1-T00</b>	<b>PS31L-PS02R1-T00</b>	<b>PS31L-PS02W0-T00</b>	<b>PS31L-PS02LW-T00</b>
Slow 1NO+2NC	⊖	<b>PS31L-PT12W1-T00</b>	<b>PS31L-PT12R1-T00</b>	<b>PS31L-PT12W0-T00</b>	<b>PS31L-PT12LW-T00</b>
Slow 2NO+1NC	⊖	<b>PS31L-PT21W1-T00</b>	<b>PS31L-PT21R1-T00</b>	<b>PS31L-PT21W0-T00</b>	<b>PS31L-PT21LW-T00</b>
Slow 3NC	⊖	<b>PS31L-PT03W1-T00</b>	<b>PS31L-PT03R1-T00</b>	<b>PS31L-PT03W0-T00</b>	<b>PS31L-PT03LW-T00</b>
Slow 3NO		<b>PS31L-PT30W1-T00</b>	<b>PS31L-PT30R1-T00</b>	<b>PS31L-PT30W0-T00</b>	<b>PS31L-PT30LW-T00</b>

## General specifications (for all types)

Degree of protection	IP 65 (plastic body) IP 66 (metal body)	Rated operational current	
Rated insulation voltage plastic body	(U)	le/AC-15 230 VAC	3.1 A
according to IEC 60947-1 and EN 60947-1	500 V	le/AC-13 24 VDC	2.8 V
according to UL 508, CSA C22-2 n°14	A 600, Q 600	Electrical durability (according to IEC 60947-5-1 annex C)	
Rated insulation voltage metal body	(U)	max. switching frequency Cycles/h	3600
according to IEC 60947-1 and EN 60947-1	400 V (PS21, PS42), 500 V (PS31, PS43)	load factor	0.5
according to UL 508, CSA C22-2 n°14	A 300, Q 300 (PS21, PS42) A 600, Q 600 (PS31, PS43)	Air temperature near the device	
Conventional enclosed thermal voltage (U <sub>imp</sub> )	6 kV	during operation	-25 to +70°C
		for storage	-30 to +80°C
		Approvals	CE - UL - CSA

\* also available in metal (M type)

\*\* Ov. : overlapping travel paths

CARLO GAVAZZI Automation Components. Specifications are subject to change without notice. Illustrations are for example only.

# Limit switches - Safety type

## Head types

Key Actuator 90° adj. head (key must be ordered separately)

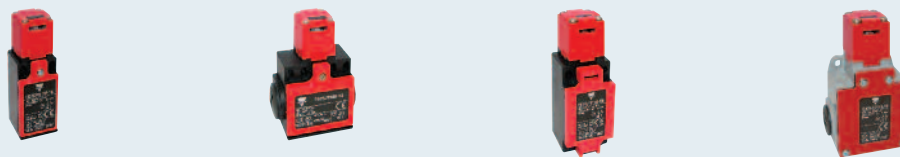

### Family: S

	PS21	PS42	PS31	PS43
	Thermoplastic*	Thermoplastic*	Thermoplastic*	Metal
Dimensions (mm) WxHxD	30.3 x 90 x 30	57 x 83 x 33	41.3 x 109.5 x 41	43 x 104.5 x 66

### References contact block

Snap 1NO+1NC	⊖ PS21S-PS1105-T00	PS42S-PS1105-T00	PS31S-PS1105-T00	PS43S-PS1105-Y00
Snap 2NC	⊖ PS21S-PS0205-T00	PS42S-PS0205-T00	PS31S-PS0205-T00	PS43S-PS0205-Y00
Slow 1NO+1NC	⊖ PS21S-PT1105-T00	PS42S-PT1105-T00	PS31S-PT1105-T00	PS43S-PT1105-Y00
Slow Ov.**1NO+1NC	⊖ PS21S-PO1105-T00	PS42S-PO1105-T00	PS31S-PO1105-T00	PS43S-PO1105-Y00
Slow 2NC	⊖ PS21S-PT0205-T00	PS42S-PT0205-T00	PS31S-PT0205-T00	PS43S-PT0205-Y00
Slow 2NO+1NC	⊖		PS31S-PT2105-T00	PS43S-PT2105-Y00
Slow 1NO+2NC	⊖		PS31S-PT1205-T00	PS43S-PT1205-Y00
Slow 3NC	⊖		PS31S-PT0305-T00	PS43S-PT0305-Y00

## Head types

Key actuator fully turnable head (key must be ordered separately)

Hinge Switch Operated lever\*



### Family: S / H

	PS21	PS42	PS21	PS42
	Thermoplastic*	Thermoplastic*	Thermoplastic*	Thermoplastic*
Dimensions (mm) WxHxD	30.3 x 98.6 x 30	57 x 91.5 x 33	30.3 x 157 x 42	57 x 150 x 42

### References contact block

Snap 1NO+1NC	⊖ PS21S-PS1109-T00	PS42S-PS1109-T00	PS21H-PS11HC-T00	PS42H-PS11HC-T00
Snap 2NC	⊖ PS21S-PS0209-T00	PS42S-PS0209-T00	PS21H-PS02HC-T00	PS42H-PS02HC-T00
Slow 1NO+1NC	⊖ PS21S-PT1109-T00	PS42S-PT1109-T00	PS21H-PT11HC-T00	PS42H-PT11HC-T00
Slow Ov.**1NO+1NC	⊖ PS21S-PO1109-T00	PS42S-PO1109-T00	PS21H-PO11HC-T00	PS42H-PO11HC-T00
Slow 2NC	⊖ PS21S-PT0209-T00	PS42S-PT0209-T00	PS21H-PT02HC-T00	PS42H-PT02HC-T00

## Head types

Hinge shaft Zinc plated steel

Hinge Shaft Stainless steel

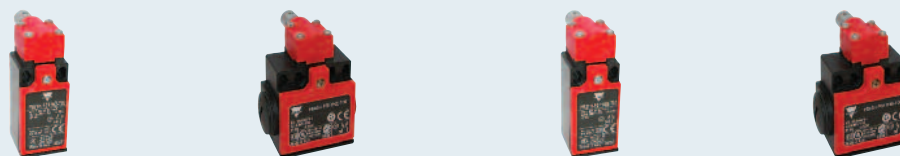

### Family: H

	PS21	PS42	PS21	PS42
	Thermoplastic*	Thermoplastic*	Thermoplastic*	Thermoplastic*
Dimensions (mm) WxHxD	30.3 x 79.5 x 51.2	57 x 72.5 x 52.5	30.3 x 79.5 x 51.2	30.3 x 72.5 x 52.5

### References Contact Block

Snap 1NO+1NC	⊖ PS21H-PS11HZ-T00	PS42H-PS11HZ-T00	PS21H-PS11HS-T00	PS42H-PS11HS-T00
Snap 2NC	⊖ PS21H-PS02HZ-T00	PS42H-PS02HZ-T00	PS21H-PS02HS-T00	PS42H-PS02HS-T00
Slow 1NO+1NC	⊖ PS21H-PT11HZ-T00	PS42H-PT11HZ-T00	PS21H-PT11HS-T00	PS42H-PT11HS-T00
Slow Ov.**1NO+1NC	⊖ PS21H-PO11HZ-T00	PS42H-PO11HZ-T00	PS21H-PO11HS-T00	PS42H-PO11HS-T00
Slow 2NC	⊖ PS21H-PT02HZ-T00	PS42H-PT02HZ-T00	PS21H-PT02HS-T00	PS42H-PT02HS-T00

\* also available in metal (Y type)

\*\* Ov. : overlapping travel paths

# Limit switches - Safety type

## Head types

### Pull wire activated head 16m cable max



## Family: R

	PS31 Metal	PS43 Metal
Dimensions (mm) WxHxD	40 x 162.75 x 43	63 x 158.25 x 43.3

## References contact block

	PS31R-PS11N7-Y00	PS43R-PS11N7-Y00
Snap 1NO+1NC	PS31R-PS02N7-Y00	PS43R-PS02N7-Y00
Snap 2NC	PS31R-PT11N7-Y00	PS43R-PT11N7-Y00
Slow 1NO+1NC	PS31R-PO11N7-Y00	PS43R-PO11N7-Y00
Slow Ov.**1NO+1NC	PS31R-PT02N7-Y00	PS43R-PT02N7-Y00
Slow 2NC	PS31R-PT21N7-Y00	PS43R-PT21N7-Y00
Slow 2NO+1NC	PS31R-PT12N7-Y00	PS43R-PT12N7-Y00
Slow 1NO+2NC	PS31R-PT03N7-Y00	PS43R-PT03N7-Y00
Slow 3NC		

## Head types

### Pull wire activated head with pull button reset - 16m cable max



## Family: H

	PS31 Metal	PS43 Metal
Dimensions (mm) WxHxD	40 x 162.75 x 44	63 x 158.25 x 44

## References contact block

	PS31R-PS11N7-YK0	PS43R-PS11N7-YK0
Snap 1NO+1NC	PS31R-PS02N7-YK0	PS43R-PS02N7-YK0
Snap 2NC	PS31R-PT11N7-YK0	PS43R-PT11N7-YK0
Slow 1NO+1NC	PS31R-PO11N7-YK0	PS43R-PO11N7-YK0
Slow Ov.**1NO+1NC	PS31R-PT02N7-YK0	PS43R-PT02N7-YK0
Slow 2NC	PS31R-PT21N7-YK0	PS43R-PT21N7-YK0
Slow 2NO+1NC	PS31R-PT12N7-YK0	PS43R-PT12N7-YK0
Slow 1NO+2NC	PS31R-PT03N7-YK0	PS43R-PT03N7-YK0
Slow 3NC		

## General specifications (for all types)

Degree of protection	IP 65 (plastic body) IP 66 (metal body)	Rated operational current	
Rated insulation voltage plastic body	(U <sub>i</sub> )	le/AC-15 230 VAC	3.1 A
according to IEC 60947-1 and EN 60947-1	500 V	le/AC-13 24 VDC	2.8 V
according to UL 508, CSA C22-2 n°14	A 600, Q 600	Electrical durability (according to IEC 60947-5-1 annex C)	
Rated insulation voltage metal body	(U <sub>i</sub> )	max. switching frequency Cycles/h	3600
according to IEC 60947-1 and EN 60947-1	400 V (PS21, PS42), 500 V (PS31, PS43)	load factor	0.5
according to UL 508, CSA C22-2 n°14	A 300, Q 300 (PS21, PS42) A 600, Q 600 (PS31, PS43)	Air temperature near the device	
Conventional enclosed thermal voltage (U <sub>imp</sub> )	6 kV	during operation	-25 to +70°C
		for storage	-30 to +80°C
		Approvals	CE - UL - CSA

\* also available in metal (Y type)

\*\* Ov. : overlapping travel paths

# Limit switches - Safety type with pull button reset

## Head types

**PO** Steel plunger

**PR** Steel plunger with nylon roller

**R3** Plastic roller lever on metal plunger

**RT** Lever with nylon roller



## Family: K

	PS21 Thermoplastic*	PS21 Thermoplastic*	PS21 Thermoplastic*	PS21 Thermoplastic*
Dimensions (mm) WxHxD	30.3 x 88 x 36.5	30.3 x 99 x 36.5	30.3 x 107 x 36.5	39 x 106 x 45

## References contact block

Snap 1NO+1NC	⊖	PS21K-PS11P0-T00	PS21K-PS11PR-T00	PS21K-PS11R3-T00	PS21K-PS11RT-T00
Snap 2NC	⊖	PS21K-PS02P0-T00	PS21K-PS02PR-T00	PS21K-PS02R3-T00	PS21K-PS02RT-T00
Slow 1NO+1NC	⊖	PS21K-PT11P0-T00	PS21K-PT11PR-T00	PS21K-PT11R3-T00	PS21K-PT11RT-T00
Slow 2NC	⊖	PS21K-PT02P0-T00	PS21K-PT02PR-T00	PS21K-PT02R3-T00	PS21K-PT02RT-T00



## Family: K

	PS42 Thermoplastic*	PS42 Thermoplastic*	PS42 Thermoplastic*	PS42 Thermoplastic*
Dimensions (mm) WxHxD	57 x 81 x 36.5	57 x 92 x 36.5	57 x 100 x 36.5	57 x 99 x 45

## References contact block

Snap 1NO+1NC	⊖	PS42K-PS11P0-T00	PS42K-PS11PR-T00	PS42K-PS11R3-T00	PS42K-PS11RT-T00
Snap 2NC	⊖	PS42K-PS02P0-T00	PS42K-PS02PR-T00	PS42K-PS02R3-T00	PS42K-PS02RT-T00
Slow 1NO+1NC	⊖	PS42K-PT11P0-T00	PS42K-PT11PR-T00	PS42K-PT11R3-T00	PS42K-PT11RT-T00
Slow 2NC	⊖	PS42K-PT02P0-T00	PS42K-PT02PR-T00	PS42K-PT02R3-T00	PS42K-PT02RT-T00

## Head types

**R4** Roller Lever, external side actuation

**LR** Roller Lever Ø22, side actuation



## Family: K

	PS21 Thermoplastic*	PS42 Thermoplastic*
Dimensions (mm) WxHxD	44 x 107 x 36.5	57 x 112 x 36.5

## References contact block

Snap 1NO+1NC	⊖	PS21K-PS11R4-T00	PS42K-PS11LR-T00
Snap 2NC	⊖	PS21K-PS02R4-T00	PS42K-PS02LR-T00
Slow 1NO+1NC	⊖	PS21K-PT11R4-T00	PS42K-PT11LR-T00
Slow 2NC	⊖	PS21K-PT02R4-T00	PS42K-PT02LR-T00

## General specifications (for all types)

Degree of protection for plastic body	IP 65	Rated thermal current	
Rated insulation voltage plastic body	(U <sub>i</sub> )	le/AC-15 230 VAC	3.1 A
according to IEC 60947-1 and EN 60947-1	500 V	le/AC-13 24 VDC	2.8 V
according to UL 508, CSA C22-2 n°14	A 600, Q 600	Electrical durability (according to IEC 60947-5-1 annex C)	
Rated insulation voltage metal body	(U <sub>i</sub> )	max. switching frequency Cycles/h	3600
according to IEC 60947-1 and EN 60947-1	400V	load factor	0.5
	500V	Air temperature near the device	
according to UL 508, CSA C22-2 n°14	A 300, Q 300 (PS21, PS42)	during operation	-25 to +70°C
	A 600, Q 600 (PS31, PS43)	for storage	-30 to +80°C
Conventional enclosed thermal voltage (U <sub>mp</sub> )	6 kV	Approvals	CE - UL - CSA

\* Also available in metal (Y type) other types available

CARLO GAVAZZI Automation Components. Specifications are subject to change without notice. Illustrations are for example only.

# Pilot lights

Series	Type PL High Lens	Type PL Round Lens	Type PL Low Lens	Type PL Teeth Lens
				

## General specifications

Dimensions Ø x H mm	Ø22 x 52*/67	Ø22 x 41*/54	Ø22 x 52*/67	Ø22 x 52*/67
Colours	R, W, B, Y, G**	R, W, B, Y, G**	R, W, B, Y, G**	R, W, B, Y, G**
Light source	LED	LED	LED	LED
Ultrahigh brightness	≥100 cd/m <sup>2</sup>	≥100 cd/m <sup>2</sup>	≥100 cd/m <sup>2</sup>	≥100 cd/m <sup>2</sup>
Approvals	CE - cULus	CE - cULus	CE - cULus	CE - cULus

## References

Types / voltages				
6VAC/DC	PL22*HL**-06	PL22*RL**-06	PL22*LL**-06	PL22*TL**-06
12VAC/DC	PL22*HL**-12	PL22*RL**-12	PL22*LL**-12	PL22*TL**-12
24VAC/DC	PL22*HL**-24	PL22*RL**-24	PL22*LL**-24	PL22*TL**-24
48VAC/DC	PL22*HL**-48	PL22*RL**-48	PL22*LL**-48	PL22*TL**-48
110VAC/DC	PL22*HL**-110	PL22*RL**-110	PL22*LL**-110	PL22*TL**-110
220VDC	PL22*HL**-220D	PL22*RL**-220D	PL22*LL**-220D	PL22*TL**-220D
220VAC	PL22*HL**-220A	PL22*RL**-220A	PL22*LL**-220A	PL22*TL**-220A

Series	Type PL Flash Light	Type PL Two Colours	Type PL Flashing Buzzer	Type PL Buzzer
				

## General specifications

Dimensions Ø x H mm	Ø22 x 67	Ø22 x 67	Ø22 x 67	Ø22 x 67
Colours	R, W, B, Y, G**	RG**	R**	K**
Light source	LED	LED	LED	
Sound source			Interrupted	Interrupted
Ultrahigh brightness	≥100 cd/m <sup>2</sup>	≥100 cd/m <sup>2</sup>	≥100 cd/m <sup>2</sup>	≥100 cd/m <sup>2</sup>
Approvals	CE - cULus	CE - cULus	CE - cULus	CE - cULus

## References

Types / voltages				
6 VAC/DC	PL22SFL**-06	PL22STCRG-06	PL22SFBZR-06	PL22SBZK-06
12 VAC/DC	PL22SFL**-12	PL22STCRG-12	PL22SFBZR-12	PL22SBZK-12
24 VAC/DC	PL22SFL**-24	PL22STCRG-24	PL22SFBZR-24	PL22SBZK-24
48 VAC/DC	PL22SFL**-48	PL22STCRG-48	PL22SFBZR-48	PL22SBZK-48
110 VAC/DC	PL22SFL**-110	PL22STCRG-110	PL22SFBZR-110	PL22SBZK-110
220 VDC	PL22SFL**-220D	PL22STCRG-220D	PL22SFBZR-220D	PL22SBZK-220D
220 VAC	PL22SFL**-220A	PL22STCRG-220A	PL22SFBZR-220A	PL22SBZK-220A

\* C=Compact version; S=Standard version

\*\* R=Red, W=Clear/White, K=Black, B=Blue, Y=Yellow, G=Green

## Push buttons

Series	Type PB Flush round push buttons	Type PB Extended push buttons	Type PB Red emergency stop push buttons	Type PB Mushroom push buttons
				

### General specifications

Drilling Diameter Ømm	Ø22	Ø22	Ø22	Ø22
Dimensions Ø x H mm	37 x Ø29 / 39 x Ø35	42 x Ø29 / 44 x Ø35	50 x Ø40-Ø60	50 x Ø40-Ø60
Spring Returned	Yes	Yes	No	Yes
Maintained	Yes	Yes	Yes (turn to release)	Yes
Available colours	R, W, K, B, Y, G*	R, W, K, B, Y, G*	R*	R, Y, G, W, K (only without lamp)*
Lamp add-on possibility	Yes	Yes	No	Yes
Approvals	CE - cULus	CE - cULus	CE - cULus	CE - cULus

### References

Standard style	<b>PB22SF</b>	<b>PB22SE</b>	<b>PB22SEM</b>	<b>PB22SM</b>
Bezel style	<b>PB22BF</b>	<b>PB22BE</b>	<b>PB22BEM</b>	<b>PB22BM</b>

Series	Type PB Short-handle rotary switches	Type PB Long-handle rotary switches	Type PB Key switches	Type PB I/O push button
				

### General specifications

Drilling Diameter Ømm	Ø22	Ø22	Ø22	Ø22
Dimensions Ø x H mm	51 x Ø22 / 53 x Ø30	51 x Ø22 / 53 x Ø30	72 x Ø22 / 68 x Ø30	41 x 54 x 29
Spring Returned	Yes	Yes	No	Yes
Two position	Yes	Yes	Yes	No
Three position	Yes	Yes	Yes	No
Available colours	R, Y, G, B, W, K (only without lamp)*	R, K, Y, G*	Neutral (metal)	RG*
Lamp add-on possibility	Yes	No	No	Yes
Approvals	CE - cULus	CE - cULus	CE - cULus	CE - cULus

### References



Standard style	<b>PB22SSRS</b>	<b>PB22SLRS</b>	<b>PB22SKRS</b>	<b>PB22SIO</b>
Bezel style	<b>PB22BSRS</b>	<b>PB22BLRS</b>		



\* R=Red, W=Clear/White, K=Black, B=Blue, Y= Yellow, G=Green



# Push buttons







## Push Buttons Accessories

Types	Metal holder	Plastic holder	Nut holder
Drives, Inverters			
Dimensions (mm) WxHxD	27 x 43 x 20	30 x 31 x 20	Ø29 x 42 x 23
Material	Zn + PBT	PBT	PC
References	<b>PBMBM</b>	<b>PBMBP</b>	<b>PBMBN</b>

Types	Type PA2 Contact block	Type PALAMP Lamp element (with LED)
		
Dimensions (mm) WxHxD	32 x 29 x 24	35 x 29 x 32
Contact Rating		
AC1	10 A - 250 VAC	
AC15	6 A - 220 VAC	
DC13	6 A - 24 VDC	
Approvals	CE - cULus	CE - cULus



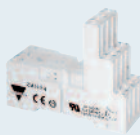

References	
Voltages	
6 VAC/DC	<b>PALAMP06</b>
12 VAC/DC	<b>PALAMP12</b>
24 VAC/DC	<b>PALAMP24</b>
48 VAC/DC	<b>PALAMP48</b>
110 VAC/DC	<b>PALAMP110</b>
220 VAC	<b>PALAMP220A</b>
220 VDC	<b>PALAMP220D</b>
Contact Configuration	
Snap 2NO	<b>PA2200/1</b>
Snap 2NC	<b>PA2020/1</b>
Snap 1NC	<b>PA2010/1</b>
Snap 1NO	<b>PA2100/1</b>
Snap 1NO+1NO	<b>PA2110/1</b>
Slow 2NO	<b>PA2200/2</b>
Slow 2NC	<b>PA2020/2</b>
Slow 1NC	<b>PA2010/2</b>
Slow 1NO	<b>PA2100/2</b>
Slow 1NO+1NO	<b>PA2110/2</b>

# Industrial and Midi industrial relays

		Industrial relays		Midi industrial relays	
Types	RCP 8 (2 Poles)	RCP 11 (3 Poles)	RMI 2-10 (2 Poles)	RMI 4-5 (2 Poles)	
					
Dimensions (mm) HxWxD	56 x 35.5 x 35.5	56 x 35.5 x 35.5	36 x 21.5 x 28	36 x 21.5 x 28	
No. of Contacts	2 Change-over (octal)	3 change-over (undecal)	2 Change-over	4 Change-over	
Contact rating	10 A	10 A	10 A	5 A	
Features standard with:	Test button/Flag/LED	Test button/Flag/LED	Test button/Flag/LED	Test button/Flag/LED	
<b>Output specifications</b>					
Max. load AC1	12 A / 250 VAC	12 A / 250 VAC	12 A / 250 VAC	6 A / 250 VAC	
Min. load	100 mA / 12 VDC	100 mA / 125 VDC	100 mA / 5 VDC	100 mA / 5 VDC	
Electrical life	> 100.000 cycles	> 100.000 cycles	> 100.000 cycles	> 100.000 cycles	
Switching power	2500 VA (resistive)	2500 VA (resistive)	2500 VA (resistive)	1250 VA (resistive)	
<b>General specifications</b>					
Voltage ranges VDC	6 - 12 - 24 - 48 - 60 - 100 - 110	6 - 12 - 24 - 48 - 60 - 100 - 110	5 - 6 - 9 - 12 - 24 - 36 - 48 - 60 - 100 - 110 - 220 - 240	5 - 6 - 9 - 12 - 24 - 36 - 48 - 60 - 100 - 110 - 220 - 240	
Voltage ranges VAC	6 - 12 - 24 - 48 - 115/120 - 230	6 - 12 - 24 - 48 - 115/120 - 230	6 - 12 - 24 - 36 - 48 - 115/120 - 220 - 240 - 380	6 - 12 - 24 - 36 - 48 - 115/120 - 220 - 240 - 380	
Insulation according to	EN 61810-5	EN 61810-5	EN 61810-5	EN 61810-5	
Consumption	1.5 W DC-2.5 VA AC	1.5 W DC-2.5 VA AC	1 W DC-1.5 VA AC	1 W DC-1.5 VA AC	
Approvals/Conformity	UL - CSA - TÜV - IMQ	UL - CSA - TÜV - IMQ	UL - CSA - TÜV - IMQ	UL - CSA - TÜV - IMQ	
<b>References</b>					
5 VDC			<b>RMIA/B2-105 DC</b>	<b>RMIA/B4-55 DC</b>	
6 VAC	<b>RCP80026 VDC</b>	<b>RCP110036 VDC</b>	<b>RMIA/B2-106 AC</b>	<b>RMIA/B4-56 AC</b>	
6 VDC	<b>RCP80026 VAC</b>	<b>RCP110036 VAC</b>	<b>RMIA/B2-106 DC</b>	<b>RMIA/B4-56 DC</b>	
12 VAC	<b>RCP800212 VAC</b>	<b>RCP1100312 VAC</b>	<b>RMIA/B2-1012 AC</b>	<b>RMIA/B4-512 AC</b>	
12 VDC	<b>RCP800212 VDC</b>	<b>RCP1100312 VDC</b>	<b>RMIA/B2-1012 DC</b>	<b>RMIA/B4-512 DC</b>	
24 VAC	<b>RCP800224 VAC</b>	<b>RCP1100324 VAC</b>	<b>RMIA/B2-1024 AC</b>	<b>RMIA/B4-524 AC</b>	
24 VDC	<b>RCP800224 VDC</b>	<b>RCP1100324 VDC</b>	<b>RMIA/B2-1024 DC</b>	<b>RMIA/B4-524 DC</b>	
48 VAC	<b>RCP800248 VAC</b>	<b>RCP1100348 VAC</b>	<b>RMIA/B2-1048 AC</b>	<b>RMIA/B4-548 AC</b>	
48 VDC	<b>RCP800248 VDC</b>	<b>RCP1100348 VDC</b>	<b>RMIA/B2-1048 DC</b>	<b>RMIA/B4-548 DC</b>	
60 VDC	<b>RCP800260 VDC</b>	<b>RCP1100360 VDC</b>	<b>RMIA/B2-1060 DC</b>	<b>RMIA/B4-560 DC</b>	
100 VDC	<b>RCP8002100 VDC</b>	<b>RCP11003100 VDC</b>	<b>RMIA/B2-10100 DC</b>	<b>RMIA/B4-5100 DC</b>	
110 VDC	<b>RCP8002110 VDC</b>	<b>RCP11003110 VDC</b>	<b>RMIA/B2-10110 DC</b>	<b>RMIA/B4-5110 DC</b>	
115/120 VAC	<b>RCP8002115/120 VAC</b>	<b>RCP11003115/120 VAC</b>	<b>RMIA/B2-10115 AC</b>	<b>RMIA/B4-5115 AC</b>	
230 VAC	<b>RCP8002230 VDC</b>	<b>RCP11003230 VDC</b>	<b>RMIA/B2-10230 AC</b>	<b>RMIA/B4-5230 AC</b>	
		Industrial relays sockets		Midi industrial relays sockets	
Types	ZPD 8XA ZPD 11XA	ZPD 8A ZPD 11A	ZMI 2NA ZMI 4NA	ZMI 2 / 3 / 4SA	
					
<b>General specifications</b>					
Dimensions (mm) HxWxD	65 X 27 X 38	65 X 27 X 38	42.5 x 75 x 27	42.5 x 75 x 27	
Rated volt. / Rated curr.	10 A @ 400 VAC	10 A @ 400 VAC	10 A @ 300 VAC	10/12 A @ 300 VAC	
Insulation voltage	> 3 kV	> 3 kV	> 4 kV	> 4 kV	
Socket material	Self-ext. PA6 + GF (V1)	Self-ext. PA6 + GF (V1)	Self-ext. PA6 + GF (V2)	Self-ext. PA6 + GF (V2)	
Mounting	DIN-rail	DIN-rail	DIN-rail	DIN-rail	
Protection degree	IP 20	IP 20	IP 20	IP 20	
Approvals	CE - UL - CSA (10 A 300 VCA)	CE - UL	CE - UL - IMQ - RINA	CE - UL - CSA	
<b>References</b>					
For RCP 8 / RCP 11	<b>ZPD 8XA / ZPD 11XA</b>	<b>ZPD 8A / ZPD 11A</b>			
For RMI2-10 / RMI4-5			<b>ZMI 2NA / ZMI 4NA</b>	<b>ZMI 2 / 3 / 4SA</b>	

# Midi industrial relays

## Midi industrial relays

Types	RPY 1	RPY 2	RPY 3	RPY 4
				
Dimensions (mm) HxWxD	36 x 21.5 x 28	36 x 21.5 x 28	36 x 31.5 x 28	36 x 41.5 x 28
No. of Contacts	Faston or PCB	Faston or PCB	Faston or PCB	Faston or PCB
Contact rating	1 Change-over	2 Change-over	3 Change-over	4 Change-over
Terminal types	16 A	10 A	10 A	10 A

### Output specifications

Max. load AC1	16 A	10 A	10 A	10 A
Electrical life	1 x 10 <sup>5</sup>	1 x 10 <sup>5</sup>	1 x 10 <sup>5</sup>	1 x 10 <sup>5</sup>
Switching power	1 HP at 240 VAC 1/2 HP at 120 VAC	3/4 HP at 240 VAC 1/3 HP at 120 VAC	3/4 HP at 240 VAC 1/3 HP at 120 VAC	3/4 HP at 240 VAC 1/3 HP at 120 VAC

### General specifications

Voltage ranges VDC	6 - 9 - 12 - 24 - 36 - 48 100 - 110 - 220 - 240	6 - 9 - 12 - 24 - 36 - 48 100 - 110 - 220 - 240	6 - 9 - 12 - 24 - 36 - 48 100 - 110 - 220	6 - 9 - 12 - 24 - 36 - 48 100 - 110 - 220
Voltage ranges VAC	6 - 12 - 24 - 36 - 48 - 110 120 - 120 - 220 - 240 - 380	6 - 12 - 24 - 36 - 48 - 110 120 - 120 - 220 - 240 - 380	6 - 12 - 24 - 36 - 48 - 110 120 - 120 - 220 - 240 - 380	6 - 12 - 24 - 36 - 48 - 110 120 - 120 - 220 - 240 - 380
Insulation Coil/Contact	2000/1200 VAC	2000/1200 VAC	2000/1200 VAC	2000/1200 VAC
Consumption	DC=0.9 W - AC=1.2 VA	DC=0.9 W - AC=1.2 VA	DC=1.4 W - AC=2 VA	DC=1.5 W - AC=2.5 VA
Approvals/Conformity	UL - CSA - TÜV	UL - CSA - TÜV	UL - CSA - TÜV	UL - CSA - TÜV

### References

Consult your Carlo Gavazzi Partner or Distributor	Several options available: Led, diode, etc...	Several options available: Led, diode, etc...	Several options available: Led, diode, etc...	Several options available: Led, diode, etc...
---	--	--	--	--

## Midi industrial relays sockets

Types	ZPY08A	ZPY11A	ZPY14A
			

### General specifications





Dimensions (mm) HxWxD	27.8 x 30 x 69.8	27.8 x 40 x 69.8	27.8 x 50.5 x 69.8
Rated volt. / Rated curr.	10 A @ 300 VAC	10 A @ 300 VAC	10 A @ 300 VAC
Insulation voltage	> 4 kW	> 4 kW	> 4 kW
Socket material	PA6 - V2	PA6 - V2	PA6 - V2
Mounting	DIN Rail	DIN Rail	DIN Rail
Protection degree	IP 00	IP 00	IP 00
Approvals	UL - cUL - CSA	UL - cUL - CSA	UL - cUL - CSA

### References

Consult your Carlo Gavazzi Partner or Distributor	For Relays: RPYA 001 and RPYA 002	For Relays: RPYA 003	For Relays: RPYA 004
---	-----------------------------------	----------------------	----------------------

# Power relays

## Power relays

Types	NA (1/2 Poles)	NB (1/2 Poles)	NF (1/2 Poles)	NP (1/2 Poles)
				
Dimensions (mm) HxWxD	36 x 50.5 x 33.5	55 x 50.5 x 54.5	36 x 50.5 x 54.5	36 x 50.5 x 33.5
No. of Contacts	1 Normally open 2 Normally open	1 Normally open 2 Normally open	1 Normally open 2 Normally open	1 Normally open 2 Normally open
Contact rating	30 A	30 A	30 A	30 A
Terminal types	Faston	Bolt	Faston	PCB
<b>Output specifications</b>				
Max. load AC1	30 A (1NO) - 25 A (2NO)	30 A (1NO) - 25 A (2NO)	30 A (1NO) - 25 A (2NO)	30 A (1NO) - 25 A (2NO)
Electrical life	1 x 10 <sup>5</sup>	1 x 10 <sup>5</sup>	1 x 10 <sup>5</sup>	1 x 10 <sup>5</sup>
Switching power	7500 VA / 840 W	7500 VA / 840 W	7500 VA / 840 W	7500 VA / 840 W
<b>General specifications</b>				
Voltage ranges VDC	3 - 6 - 12 - 24 - 48 100 - 110 - 200	3 - 6 - 12 - 24 - 48 100 - 110 - 200	3 - 6 - 12 - 24 - 48 100 - 110 - 200	3 - 6 - 12 - 24 - 48 100 - 110 - 200
Voltage ranges VAC	6 - 12 - 24 - 48 - 120 - 220	6 - 12 - 24 - 48 - 120 - 220	6 - 12 - 24 - 48 - 120 - 220	6 - 12 - 24 - 48 - 120 - 220
Insulation according to	4000 VAC	4000 VAC	4000 VAC	4000 VAC
Consumption	DC=1.9 W - AC=2.7 VA	DC=1.9 W - AC=2.7 VA	DC=1.9 W - AC=2.7 VA	DC=1.9 W - AC=2.7 VA
Approvals/Conformity	UL - cUL	UL - cUL	UL - cUL	UL - cUL

### CF (2 Poles)



### CS (2 Poles)

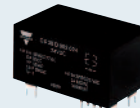

Dimensions (mm) HxWxD	26.42 x 68.58 x 34.54	26.42 x 52.32 x 34.54
No. of Contacts	2 Normally open 2 Change-over	2 Normally open 2 Change-over
Contact rating	30 A	30 A
Terminal types	Faston	PCB
<b>Output specifications</b>		
Max. load AC1	30 A (2NO) - 20 A (2CO)	30 A (2NO) - 20 A (2CO)
Electrical life	1 x 10 <sup>5</sup>	1 x 10 <sup>5</sup>
Switching power	8310 VA / 840 W	8310 VA / 840 W
<b>General specifications</b>		
Voltage ranges VDC	6 - 12 - 24 - 48	6 - 12 - 24 - 48
Voltage ranges VAC	24 - 120 - 208 - 240 - 277	24 - 120 - 208 - 240 - 277
Insulation according to	4000 VAC	4000 VAC
Consumption	DC=1.7 W - AC=4 VA	DC=1.7 W - AC=4 VA
Approvals/Conformity	UL - cUL	UL - cUL

# Sockets and Modules

Types	ZD 35/2A	ZD 50/2A	ZD 35/3A	ZD 50/3A

## General specifications

Rated volt. / Rated curr.	12 A @ 300 VAC	12 A @ 300 VAC	12 A @ 300 VAC	12 A @ 300 VAC
Insulation voltage	> 5 kV	> 5 kV	> 5 kV	> 5 kV
Socket material	Self-ext. PA 6 + GF (V1)	Self-ext. PA 6 + GF (V1)	Self-ext. PA 6 + GF (V1)	Self-ext. PA 6 + GF (V1)
Mounting	DIN-rail	DIN-rail	DIN-rail	DIN-rail
Protection degree	IP 20	IP 20	IP 20	IP 20
Approvals	UL - CSA (12 A, 300 VCA)	UL - CSA (12 A, 300 VCA)	UL - CSA (12 A, 300 VCA)	UL - CSA (12 A, 300 VCA)

## References

For relay:	MZ 1P 5/10 A	MZ B 1P 5/10 A	MZ 1P 5/10 A	MZ B 1P 5/10 A
	M15 M 8A	MZ 2P 5/10 A	M15 M 8A	MZ 2P 5/10 A
	M25 1P 12 A	MZ 1P 16 A	M25 1P 12 A	MZ 1P 16 A
	LC 10 A	M15 M 8 A	LC 10 A	M15 M 8 A
		M25 1P 16 A		M25 1P 16 A

For detailed informations consult your Carlo Gavazzi Partner or Distributor	Hold down spring to be ordered separately:	Hold down spring to be ordered separately:	Hold down spring to be ordered separately:	Hold down spring to be ordered separately:
	<ul style="list-style-type: none"> <li>• SZD15 for M15/M25 relays</li> <li>• SZD20 for LC relays</li> <li>• SZD25 for MZ relays</li> </ul>	<ul style="list-style-type: none"> <li>• SZD15 for M15/M25 relays</li> <li>• SZD20 for LC relays</li> <li>• SZD25 for MZ relays</li> </ul>	<ul style="list-style-type: none"> <li>• SZD15 for M15/M25 relays</li> <li>• SZD20 for LC relays</li> <li>• SZD25 for MZ relays</li> </ul>	<ul style="list-style-type: none"> <li>• SZD15 for M15/M25 relays</li> <li>• SZD20 for LC relays</li> <li>• SZD25 for MZ relays</li> </ul>

## Types

## Additional modules for ZMI and ZD sockets

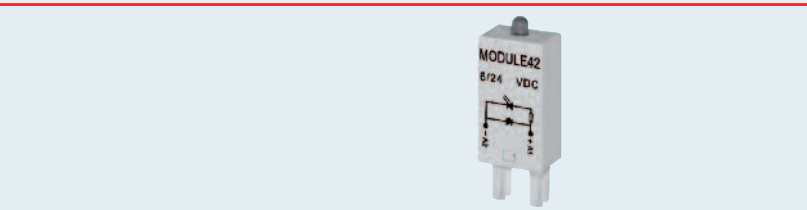

## General specifications

Dimensions (mm) HxWxD	23 x 12.5 x 8.5
Terminal material	CuSn
Protection Degree	IP 40
Operating temperature	-40°C to + 70°C
Ambient humidity	85RH non condensing
Approvals/Conformity	No approvals

## References

Consult your Carlo Gavazzi Partner or Distributor

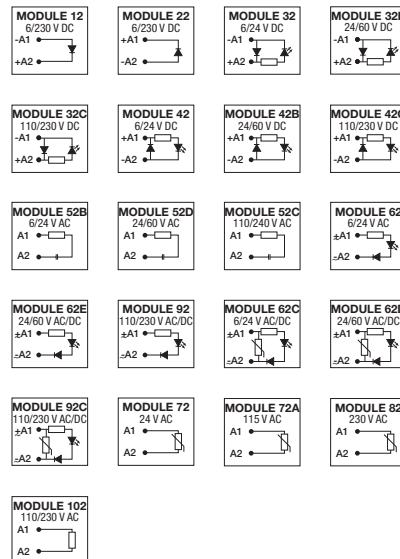



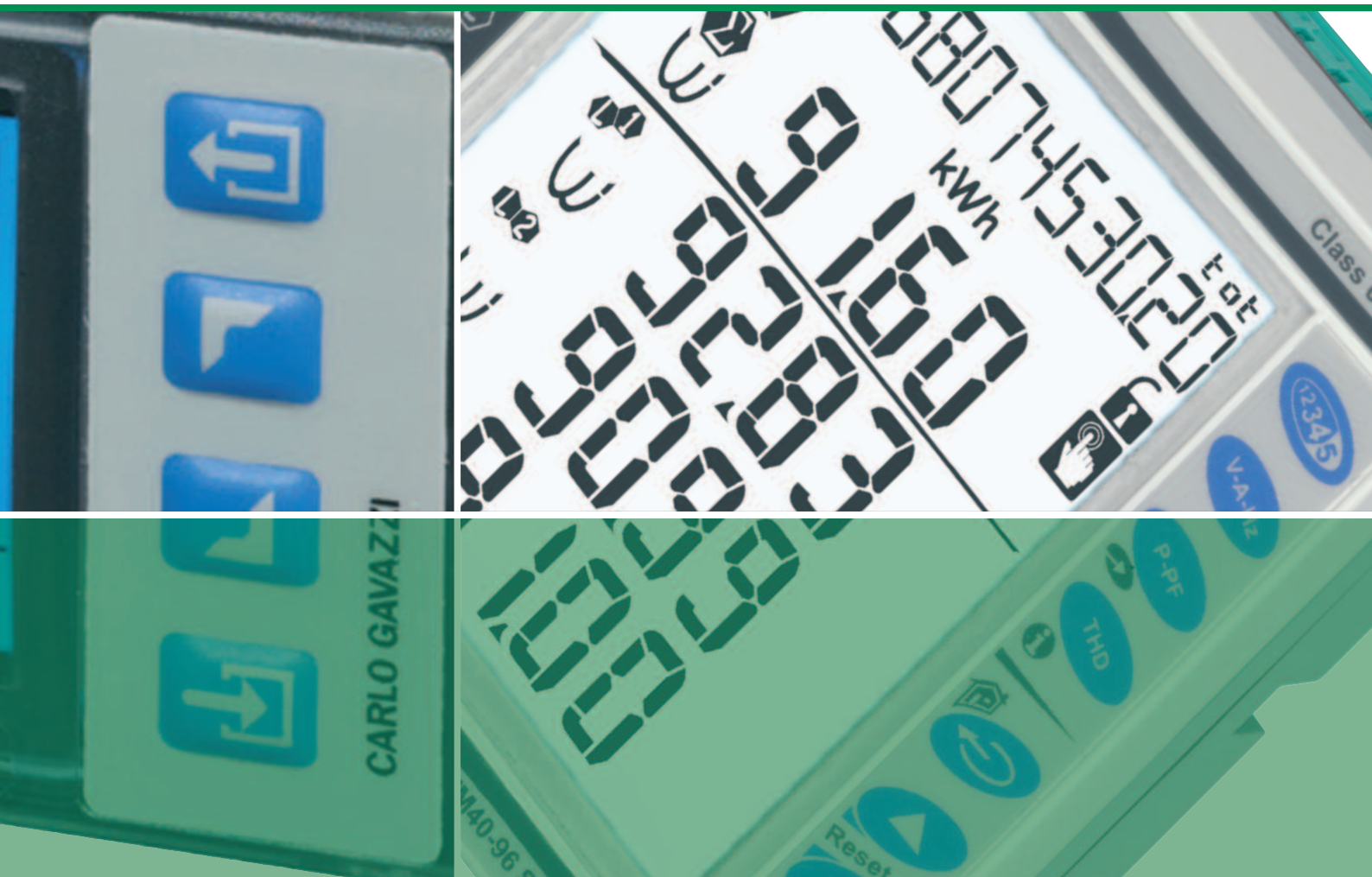

# Control



Monitoring relays	144
Timers	154
Current transformers	160
Accessories and transducer	167
Digital panel meters	168
Energy management	172
Counters	181
PID controllers	184
Switching power supplies	186
Safety modules	192

# Monitoring relays

## Current relays

Types	DIA 01 PIA 01	DIA 53	DIB 01 PIB 01
			
Dimensions (mm) HxWxD DIN RAIL housing Plug-in housing	80 x 22.5 x 99.5 [D] 80 x 36 x 94 [P]	81 x 17.5 x 67.2 [Mini-D]	80 x 22.5 x 99.5 [D] 80 x 36 x 94 [P]
Function	Over current monitoring relay. 1-phase AC/DC. Direct input or on CT 5A. Setpoint adjustable. Hysteresis adjustable.	Over current monitoring relay. 1-phase AC. Setpoint adjustable. 2-wire connection. Reaction time <50 ms for F versions. 12 mm hole for insulated current carrying wire.	Over or under current monitoring relay. 1-phase AC/DC TRMS. Direct input or on CT 10A. Setpoint adjustable. Hysteresis adjustable. Delay time adjustable. 12 mm hole for insulated current carrying wire [100 A].

## Input specifications

Measuring range	0.5-5 A AC/DC	2-20 AAC [20A] 5-50 AAC [50A] 10-100 AAC [100A]	0.1-5 mA AC/DC [5MA] 1-50 mA AC/DC [50MA] 10-500 mA AC/DC [500MA] 0.1-5 A AC/DC [5A] 1-10 A AC/DC [10A] 2-100 A AC [100A]
-----------------	---------------	---	--

## Output specifications

	1 x SPDT relay	Static output	1 x SPDT relay
Max. load AC1	8 A / 250 VAC		8 A / 250 VAC
Max. load DC12	5 A / 24 VDC	100 mA	5 A / 24 VDC
Electrical life	>1 x 10 <sup>5</sup> operations		>1 x 10 <sup>5</sup> operations

## General specifications

Power supply	24-48 V AC/DC [D48] 115/230 VAC [B23]	40 VDC max. Powered by the measured current	24-48 V AC/DC [D48] 115/230 VAC [B23] 24 VDC / 24-240 VAC [M24]
Approvals/Marks	CE - UL - CSA	CE - UL - CSA	CE - UL - CSA

## References



DIA01C D48 5A	DIA53S 724 20A	DIB01C ... 5MA
PIA01C D48 5A	DIA53S 724 50A	DIB01C ... 50MA
DIA01C B23 5A	DIA53S 724 100A	DIB01C ... 500MA
PIA01C B23 5A	DIA53S 724 20A F	DIB01C ... 5A
	DIA53S 724 50A F	DIB01C ... 10A
	DIA53S 724 100A F	DIB01C M24 100A
		PIB01C ... 5MA
		PIB01C ... 50MA
		PIB01C ... 500MA
		PIB01C ... 5A
		PIB01C ... 10A

... = insert code for Power Supply.



# Monitoring relays

## Current relays

Types	DIB 71	DIB 02 PIB 02	DIC 01 PIC 01
			

Dimensions (mm) HxWxD			
DIN RAIL housing	81 x 35.5 x 67.2 [Mini-D]	80 x 22.5 x 99.5 [D] 80 x 36 x 94 [P]	80 x 45 x 99.5 [D] 80 x 36 x 94 [P]
Plug-in housing			
Function	Over or under current monitoring relay. 1-phase AC/DC TRMS. Direct input or on CT 5A. Setpoint adjustable. Hysteresis adjustable. Delay time adjustable.	Over or under current monitoring relay. 1-phase AC/DC TRMS. Input on shunt or CT MI/MP. Setpoint adjustable. Hysteresis adjustable. Delay time adjustable.	Process signal monitoring relay. 1-phase AC/DC TRMS. Direct input, CT A82 or CT MI/MP. 2 setpoints separately adjustable. Hysteresis adjustable. 2 delay functions separately adjustable.

### Input specifications

Measuring range	0.1-5 mA AC/DC [5MA] 1-50 mA AC/DC [50MA] 10-500 mA AC/DC [500 MA] 0.1-5 A AC/DC [5A]	6-150 mV AC/DC 0.4 - 4Vp	0.5-20 mA AC/DC 0.1-10 V AC/DC 0.4 - 4Vp
-----------------	--	-----------------------------	--

### Output specifications

	1 x SPDT relay	1 x SPDT relay	1 x SPDT relay [P] 2 x SPDT relays [D]
Max. load AC1	5 A / 250 VAC	8 A / 250 VAC	5 A / 250 VAC
Max. load DC12	5 A / 24 VDC	5 A / 24 VDC	5 A / 24 VDC
Electrical life	>1 x 10 <sup>5</sup> operations	>1 x 10 <sup>5</sup> operations	>1 x 10 <sup>5</sup> operations

### General specifications





Power supply	24/48 VAC [B48] 115/230 VAC [B23]	24-48 V AC/DC [D48] 115/230 VAC [B23]	24-48 V AC/DC [D48] 115/230 VAC [B23]
Approvals/Marks	CE - UL - CSA	CE - UL - CSA	CE - UL - CSA

### References

DIB71C B48 5MA	DIB02C D48 150MV	DIC01D D48 AV0
DIB71C B48 50MA	PIB02C D48 150MV	PIC01C D48 AV0
DIB71C B48 500MA	DIB02C B23 150MV	DIC01D B23 AV0
DIB71C B48 5A	PIB02C B23 150MV	PIC01C B23 AV0
DIB71C B23 5MA		
DIB71C B23 50MA		
DIB71C B23 500MA		
DIB71C B23 5A		

# Monitoring relays

## Voltage relays

Types	DUA 01 PUA 01	DUA 52	DUA 55	DUB 01 PUB 01
				
Dimensions (mm) HxWxD	80 x 22.5 x 99.5 [D]	81 x 17.5 x 67.2 [Mini-D]	81 x 17.5 x 67.2 [Mini-D]	80 x 22.5 x 99.5 [D]
DIN RAIL housing	80 x 36 x 94 [P]			80 x 36 x 94 [P]
Plug-in housing				
Function	Over current and voltage monitoring relay. 1-phase AC/DC. Setpoint adjustable. Hysteresis adjustable.	Under voltage monitoring relay for DC battery. Setpoint adjustable. Hysteresis adjustable. Measures its own power supply.	Over and under voltage monitoring relay. 1-phase (measures its own power supply) AC TRMS.	Over or under voltage monitoring relay. 1-phase AC/DC TRMS. Setpoint adjustable. Hysteresis adjustable. Delay time adjustable.

### Input specifications

Measuring range	2-500 V AC/DC 0.4 -4 Vp	8-28 VDC [724] 38-58 VDC [748]	208/220/230/240 VAC	0.1-10 V AC/DC [10V] 2-500 V AC/DC [500V]
-----------------	----------------------------	-----------------------------------	---------------------	--

### Output specifications

	1 x SPDT relay	1 x SPDT relay	1 x SPDT relay	1 x SPDT relay
Max. load AC1	8 A / 250 VAC	5 A / 250 VAC	5 A / 250 VAC	8 A / 250 VAC
Max. load DC12	5 A / 24 VDC	5 A / 24 VDC	5 A / 24 VDC	5 A / 24 VDC
Electrical life	>1 x 10 <sup>5</sup> operations	>1 x 10 <sup>5</sup> operations	>1 x 10 <sup>5</sup> operations	>1 x 10 <sup>5</sup> operations

### General specifications





Power supply	24-48 V AC/DC [D48] 115/230 VAC [B23]	8-28 VDC [724] 38-58 VDC [748]	208-480 VAC	24-48 V AC/DC [D48] 115/230 VAC [B23]
Approvals/Marks	CE, UL, CSA	CE - UL - CSA	CE - UL - CSA	CE - UL - CSA

### References

DUA01C D48 500V	DUA52 C724	DUA55 CM44	DUB01C D48 10V
PUA01C D48 500V	DUA52 C748		DUB01C D48 500V
DUA01C B23 500V			PUB01C D48 10V
PUA01C B23 500V			PUB01C D48 500V
			DUB01C B23 10V
			DUB01C B23 500V
			PUB01C B23 10V
			PUB01C B23 500V





# Monitoring relays

## Voltage relays

Types	DUB 71	DUB 02 PUB 02	DUB 03 PUB 03	DUC 01 PUC 01
				
Dimensions (mm) HxWxD DIN RAIL housing Plug-in housing	81 x 35.5 x 67.2 [Mini-D]	80 x 22.5 x 99.5 [D] 80 x 36 x 94 [P]	80 x 22.5 x 99.5 [D] 80 x 36 x 94 [P]	80 x 45 x 99.5 [D] 80 x 36 x 94 [P]
Function	Over or under voltage monitoring relay. 1-phase AC/DC TRMS. Setpoint adjustable. Hysteresis adjustable. Delay time adjustable.	Over and under voltage monitoring relay. 1-phase (measures its own power supply) AC TRMS. Over and under voltage setpoints separately adjustable. Hysteresis adjustable. Delay time adjustable (ON/OFF).	Over or under voltage monitoring relay. 1-phase (measures its own power supply) AC/DC TRMS. Setpoint adjustable. Hysteresis adjustable. Delay time adjustable.	Over and under voltage monitoring relay. 1-phase AC/DC TRMS. 2 setpoints separately adjustable. Hysteresis adjustable. 2 delay functions separately adjustable.
<b>Input specifications</b>				
Measuring range	0.1-10 V AC/DC [10V] 2-500 V AC/DC [500V]	24/115/230 VAC	24/48/115/240 V AC/DC	2-500 V AC/DC [500V]
<b>Output specifications</b>				
	1 x SPDT relay	1 x SPDT relay	1 x SPDT relay [P]	1 x SPDT relay [C] 2 x DPDT relay [D]
Max. load AC1	5 A / 250 VAC	8 A / 250 VAC	8 A / 250 VAC	8 A / 250 VAC
Max. load DC12	5 A / 24 VDC	5 A / 24 VDC	5 A / 24 VDC	5 A / 24 VDC
Electrical life	>1 x 10 <sup>5</sup> operations	>1 x 10 <sup>5</sup> operations	>1 x 10 <sup>5</sup> operations	>1 x 10 <sup>5</sup> operations
<b>General specifications</b>				
Power supply	24/48 VAC [B48] 115/230 VAC [B23]	24/115/230 VAC	12-240 V AC/DC	24-48 V AC/DC [D48] 115/230 VAC [B23]
Approvals/Marks	CE - UL - CSA	CE - UL - CSA	CE - UL - CSA	CE - UL - CSA
<b>References</b>				
	<b>DUB71C B48 10V</b>	<b>DUB02C T23</b>	<b>DUB03C W24</b>	<b>DUC01D D48 500V</b>
	<b>DUB71C B48 500V</b>	<b>PUB02C T23</b>	<b>PUB03C W24</b>	<b>PUC01C D48 500V</b>
	<b>DUB71C B23 10V</b>			<b>DUC01D B23 500V</b>
	<b>DUB71C B23 500V</b>			<b>PUC01C B23 500V</b>



# Monitoring relays

## 3-phase voltage relays

Types	DPA 01 PPA 01	DPA 51 DPA 71	DPA 03 PPA 03	DPA 53
				
Dimensions (mm) HxWxD DIN RAIL housing	80 x 22.5 x 99.5 [D]	81 x 17.5 x 67.2 [Mini-D] 81 x 35.5 x 67.2 [Mini-D]	80 x 22.5 x 99.5 [D]	81 x 17.5 x 67.2 [Mini-D]
Plug-in housing	80 x 36 x 94 [P]		80 x 36 x 94 [P]	
Function	Phase sequence, total and partial phase loss monitoring relay. 3-phase AC (measures its own power supply). Regenerated voltage.	Phase sequence, total and partial phase loss monitoring relay. 3-phase AC (measures its own power supply). Regenerated voltage.	Under voltage, phase sequence, total and partial phase loss monitoring relay. 3-phase (measures its own power supply) AC TRMS.	Under voltage, phase sequence, total and partial phase loss monitoring relay. 3-phase (measures its own power supply) AC TRMS
<b>Input specifications</b>				
Measuring range	208-240 VAC [M23] 208-415 VAC [P] [M44] 208-480 VAC [D] [M44] 380-415 VAC [P] [M48] 380-480 VAC [D] [M48] 380-600 VAC [M60] 380-690 VAC [M69]	208-240 VAC [M23] 208-480 VAC [M44] 380-480 VAC [M48]	208-240 VAC [M23] 380-415 VAC [P] [M48] 380-480 VAC [D] [M48] 600-690 VAC [M69]	208-240 VAC [M23] 380-480 VAC [M48]
<b>Output specifications</b>				
	1 x SPDT relay [C] 1 x DPDT relay [D]	1 x SPDT relay [C] 1 x DPDT relay [D]	1 x SPDT relay	1 x SPDT relay
Max. load AC1	8 A / 250 VAC	5 A / 250 VAC	8 A / 250 VAC	5 A / 250 VAC
Max. load DC12	5 A / 24 VDC	5 A / 24 VDC	5 A / 24 VDC	5 A / 24 VDC
Electrical life	>1 x 10 <sup>6</sup> operations	>1 x 10 <sup>6</sup> operations	>1 x 10 <sup>6</sup> operations	>1 x 10 <sup>6</sup> operations
<b>General specifications</b>				
Power supply	208-240 VAC [M23] 208-415 VAC [P] [M44] 208-480 VAC [D] [M44] 380-415 VAC [P] [M48] 380-480 VAC [D] [M48] 380-600 VAC [M60] 380-690 VAC [M69]	208-240 VAC [M23] 208-480 VAC [M44] 380-480 VAC [M48]	208-240 VAC [M23] 380-415 VAC [P] [M48] 380-480 VAC [D] [M48] 600-690 VAC [M69]	208-240 VAC [M23] 380-480 VAC [M48]
Approvals/Marks	CE - UL - CSA	CE - UL - CSA	CE - UL - CSA	CE - UL - CSA
<b>References</b>				
	DPA01D M23	DPA51C M44	DPA03C M23	DPA53C M23
	PPA01D M23	DPA71D M23	PPA03C M23	DPA53C M48
	DPA01C M44	DPA71D M48	DPA03C M48	
	PPA01C M44		PPA03C M48	
	DPA01D M48		DPA03C M69	
	PPA01D M48			
	DPA01C M60			
	DPA01C M69			



# Monitoring relays

## 3-phase voltage relays

Types	DPA 55	DPB 01 PPB 01	DPB 51
			
Dimensions (mm) HxWxD DIN RAIL housing Plug-in housing	81 x 17.5 x 67.2 [Mini-D]	80 x 22.5 x 99.5 [D] 80 x 36 x 94 [P]	90 x 17.5 x 67.2 [Mini-D]
Function	Over and under voltage, phase sequence, total and partial phase loss monitoring relay. 3-phase (measures its own power supply) AC TRMS. Two tolerance voltage windows.	Over and under voltage monitoring relay with phase loss and phase sequence. 3-phase +N (measures its own power supply) AC TRMS. N versions without phase sequence detection. W4 versions supplied between L and N. 2 setpoints separately adjustable. Delay time adjustable.	Over and under voltage monitoring relay with phase loss and phase sequence. 3-phase +N (measures its own power supply) AC TRMS. 2 setpoints separately adjustable. Delay time adjustable.
<b>Input specifications</b>			
Measuring range	208-480 VAC	208-240 VAC [M23] 380-415 VAC [P] [M48] 380-480 VAC [D] [M48]	208-480 VAC
<b>Output specifications</b>			
	1 x SPDT relay	1 x SPDT relay	1 x SPDT relay
Max. load AC1	5 A / 250 VAC	8 A / 250 VAC	5 A / 250 VAC
Max. load DC12	5 A / 24 VDC	5 A / 24 VDC	5 A / 24 VDC
Electrical life	>1 x 10 <sup>6</sup> operations	>1 x 10 <sup>6</sup> operations	>1 x 10 <sup>6</sup> operations
<b>General specifications</b>			
Power supply	208-480 VAC	208-240 VAC [M23] 380-415 VAC [P] [M48] 380-480 VAC [D] [M48] [W]	208-480 VAC
Approvals/Marks	CE - UL - CSA	CE - UL - CSA	CE - UL - CSA
<b>References</b>			
	<b>DPA55C M44</b>	<b>DPB01C M23</b>	<b>DPB51C M44</b>
		<b>PPB01C M23</b>	
		<b>DPB01C M23 N</b>	
		<b>PPB01C M23 N</b>	
		<b>DPB01C M48</b>	
		<b>PPB01C M48</b>	
		<b>DPB01C M48 W4</b>	
		<b>PPB01C M48 W4</b>	
		<b>DPB01C M48 N</b>	
		<b>PPB01C M48 N</b>	
		<b>DPB01C M48 N W4</b>	
		<b>PPB01C M48 N W4</b>	

# Monitoring relays

## 3-phase voltage relays

Types	DPB 71	DPB 02 PPB 02	DPC 01 PPC 01
			
Dimensions (mm) HxWxD DIN RAIL housing Plug-in housing	81 x 35.5 x 67.2 [Mini-D]	80 x 22.5 x 99.5 [D] 80 x 36 x 94 [P]	80 x 45 x 99.5 [D] 80 x 36 x 94 [P]
Function	Over and under voltage monitoring relay with phase loss and phase sequence. 3-phase +N (measures its own power supply) AC TRMS. 2 setpoints separately adjustable. Delay time adjustable.	Asymmetry monitoring relay with phase sequence/phase loss. 3-phase +N (measures its own power supply) AC TRMS. Adjustable asymmetry. Delay time adjustable.	Over and under voltage monitoring relay with phase loss/phase sequence, asymmetry and tolerance. 3-phase +N (measures its own power supply) AC TRMS. Setpoint separately adjustable by function.

### Input specifications

Measuring range	208-240 VAC [M23] 380-480 VAC [M48]	208-240 VAC [M23] 380-415 VAC [P] [M48] 380-480 VAC [D] [M48]	208-240 VAC [M23] 380-415 VAC [P] [M48] 380-480 VAC [D] [M48] 600-690 VAC [M69] Frequency 50-60 Hz 100-115 VAC [M11 400Hz] 208-240 VAC [M23 400Hz] 380-415 VAC [M48 400Hz] 440-480 VAC [M49 400Hz] 600-690 VAC [M69 400Hz] Frequency 50-400 Hz
-----------------	--	---	--

### Output specifications

	1 x SPDT relay	1 x SPDT relay	2 x SPDT relay
Max. load AC1	5 A / 250 VAC	8 A / 250 VAC	8 A / 250 VAC
Max. load DC12	5 A / 24 VDC	5 A / 24 VDC	5 A / 24 VDC
Electrical life	>1 x 10 <sup>5</sup> operations	>1 x 10 <sup>5</sup> operations	>1 x 10 <sup>5</sup> operations

### General specifications



Power supply	208-240 VAC [M23] 380-480 VAC [M48]	208-240 VAC [M23] 380-415 VAC [P] [M48] 380-480 VAC [D] [M48]	100-115 VAC [M11] 208-240 VAC [M23] 380-415 VAC [P] [M48] 380-480 VAC [D] [M48] 440-480 VAC [M49] 600-690 VAC [M69]
Approvals/Marks	CE - UL - CSA	CE - UL - CSA	CE - UL - CSA

### References

	DPB71C M23	DPB02C M23	DPC01D M23
	DPB71C M48	PPB02C M23	PPC01D M23
		DPB02C M48	DPC01D M48
		PPB02C M48	PPC01D M48
			DPC01D M69
			DPC01D M11 400HZ
			DPC01D M23 400HZ
			DPC01D M48 400HZ
			DPC01D M49 400HZ
			DPC01D M69 400HZ

# Monitoring relays

## 3-phase multifunction voltage relays

Types	DPC 71 PPC 71	DPC 02	DPC 72
			
Dimensions (mm) HxWxD	81 x 35.5 x 67.2 [D]	80 x 45 x 99.5 [D]	90 x 71.6 x 66.3 [D]
DIN RAIL housing	81.2 x 35.5 x 75 [P]		
Plug-in housing			
Function	Over and under voltage monitoring relay with phase loss/phase sequence, asymmetry and tolerance. 3-phase +N (measures its own power supply) AC TRMS. Setpoints separately adjustable by function.	Over and under voltage/over and under frequency with phase loss and phase sequence monitoring relay. 3-phase+N (measures its own power supply) AC TRMS. Setpoints separately adjustable. Separately adjustable delay times. Adjustable frequency range.	Digital interface protection relay with over and under voltage/over and under frequency, phase loss and phase sequence controls. Frequency derivative monitoring [B001, B003], voltage quality [B002], RS485 port, event counter, data-stamping and auto-test function. 3-phase (measures its own power supply) AC TRMS. Setpoints separately adjustable. Separately adjustable delay times. Programmable via PC (DpcSoft free configuration software).

### Input specifications

Measuring range	208-240 VAC [M23] 380-415 VAC [P] [M48] 380-480 VAC [D] [M48]	Voltage: 208-240 VAC [M23] 380-415 VAC [M48] 440-480 VAC [M49] 600-690 VAC [M69] Frequency: 50/60 Hz	Voltage: 380-415 VAC [M48] Frequency: 45-65 Hz
-----------------	---	--	---

### Output specifications

	2 x SPDT relays	2 x SPDT relays	1 x DPDT relays
Max. load AC1	5 A / 250 VAC	8 A / 250 VAC	8 A / 250 VAC
Max. load DC12	5 A / 24 VDC	5 A / 24 VDC	5 A / 24 VDC
Electrical life	>1 x 10 <sup>5</sup> operations	>1 x 10 <sup>5</sup> operations	>1 x 10 <sup>5</sup> operations

### General specifications

Power supply	208-240 VAC [M23] 380-415 VAC [P] [M48] 380-480 VAC [D] [M48]	208-240 VAC [M23] 308-415 VAC [M48] 440-480 VAC [M49] 600-690 VAC [M69]	308-415 VAC [M48]
Approvals/Marks	CE - UL - CSA	CE - UL - CSA - ENEL DK 5950 [B003]	CE - VDE 0126-1-1 [B002] - ENEL DK 5940 [B003]

### References

DPC71D M23	DPC02D M23	DPC72D M48 B001
PPC71D M23	DPC02D M48	DPC72D M48 B002
DPC71D M48	DPC02D M49	DPC72D M48 B003
PPC71D M48	DPC02D M69	
	DPC02D M23 B003	
	DPC02D M48 B003	

# Monitoring relays

## Frequency relays

## Cosφ relays

### Types

**DFB 01**  
**PFB 01**

**DFC 01**

**DWA 01**  
**PWA 01**

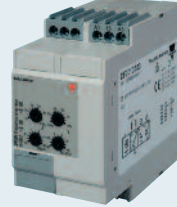

Dimensions (mm) HxWxD  
DIN RAIL housing  
Plug-in housing

80 x 22.5 x 99.5 [D]  
80 x 36 x 94 [P]

80 x 45 x 99.5 [D]

80 x 22.5 x 99.5 [D]  
80 x 36 x 94 [P]

Function

Frequency monitoring relay.  
1-phase AC (measures its own  
power supply).  
2 setpoints separately adjustable.  
Delay time adjustable.

Frequency monitoring relay.  
1-phase AC (measures its own  
power supply).  
2 setpoints separately adjustable.  
2 separately adjustable delay times.  
2 separate relay outputs.

Cosφ monitoring relay.  
1- or 3-phase AC (measures its  
own power supply).  
Direct input or through external CT.  
Power ON delay adjustable.

### Input specifications

Measuring range                      50 / 60 Hz                                      50 / 60 Hz                                      cosφ : 0.1-0.99

### Output specifications

	1 x SPDT relay	2 x SPDT relay	1 x SPDT relay
Max. load AC1	8 A / 250 VAC	8 A / 250 VAC	8 A / 250 VAC
Max. load DC12	5 A / 24 VDC	5 A / 24 VDC	5 A / 24 VDC
Electrical life	>1 x 10 <sup>5</sup> operations	>1 x 10 <sup>5</sup> operations	>1 x 10 <sup>5</sup> operations

### General specifications

Power supply	24-240 VAC	24-48 VAC [B48] 115-230 VAC [B23]	208-240 VAC [M23] 380-415 VAC [P] [M48] 380-480 VAC [D] [M48]
Approvals/Marks	CE - UL - CSA	CE - UL - CSA	CE - UL - CSA



### References

<b>DFB01C M24</b>	<b>DFC01D B48</b>	<b>DWA01C M23 5A</b>
<b>PFB01C M24</b>	<b>DFC01D B23</b>	<b>PWA01C M23 5A</b>
		<b>DWA01C M48 5A</b>
		<b>PWA01C M48 5A</b>



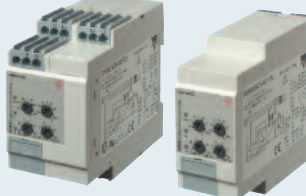

# Monitoring relays

## Power and power factor relays

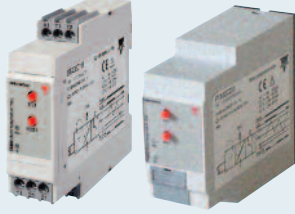

Types	DWB 01 PWB 01	DWB 02 PWB 02	DWB 03 PWB 03
			
Dimensions (mm) HxWxD			
DIN RAIL housing	80 x 45 x 99.5 [D]	80 x 45 x 99.5 [D]	80 x 45 x 99.5 [D]
Plug-in housing	80 x 36 x 94 [P]	80 x 36 x 94 [P]	80 x 36 x 94 [P]
Function	Power factor monitoring relay. 1- or 3-phase (measures its own power supply) AC TRMS. Direct input or through external CT. 2 separately adjustable setpoints. Delay time adjustable. Power ON delay adjustable.	Active power monitoring relay. 1- or 3-phase (measures its own power supply) AC TRMS. Direct input or through external CT. 2 separately adjustable setpoints. Delay time adjustable. Power ON delay adjustable.	Active power monitoring relay. 1- or 3-phase AC TRMS power direction (measures its own power supply). Direct input or through external CT. 2 separately adjustable setpoints. Delay time adjustable. Power ON delay adjustable.
<b>Input specifications</b>			
Measuring range	cosφ : 0.1-0.99	208-690 VAC 0.5-5 AAC 1-10 AAC 0.4 - 4 Vp	208-690 VAC 0.5-5 AAC 1-10 AAC 0.4 - 4 Vp
<b>Output specifications</b>			
Max. load AC1	1 x SPDT relays 8 A / 250 VAC	1 x SPDT relays 8 A / 250 VAC	1 x SPDT relays 8 A / 250 VAC
Max. load DC12	5 A / 24 VDC	5 A / 24 VDC	5 A / 24 VDC
Electrical life	>1 x 10 <sup>6</sup> operations	>1 x 10 <sup>6</sup> operations	>1 x 10 <sup>6</sup> operations
<b>General specifications</b>			
Power supply	208-240 VAC [M23] 380-415 VAC [P] [M48] 380-480 VAC [D] [M48] 600-690 VAC [M69]	208-240 VAC [M23] 380-415 VAC [P] [M48] 380-480 VAC [D] [M48] 600-690 VAC [M69]	208-240 VAC [M23] 380-415 VAC [P] [M48] 380-480 VAC [D] [M48] 600-690 VAC [M69]
Approvals/Marks	CE - UL - CSA	CE - UL - CSA	CE - UL - CSA
<b>References</b>			
	DWB01C M23 10A	DWB02C M23 10A	DWB03C M23 10A
	PWB01C M23 10A	PWB02C M23 10A	PWB03C M23 10A
	DWB01C M48 10A	DWB02C M48 10A	DWB03C M48 10A
	PWB01C M48 10A	PWB02C M48 10A	PWB03C M48 10A
	DWB01C M69 10A	DWB02C M69 10A	DWB03C M69 10A

# Monitoring relays, timers

	Temperature relays	Pump alternating relays	Timers, Delay on operate
<b>Types</b>	<b>DTA 01 PTA 01 DTA 02 PTA 02</b>	<b>DLA 71 DLA 73</b>	<b>DAA 01 PAA 01</b>
			
Dimensions (mm) HxWxD	80 x 22.5 x 99.5 [D] 80 x 36 x 94 [P]	81 x 35.5 x 67.2 [Mini-D]	80 x 22.5 x 99.5 [D] 80 x 36 x 94 [P]
DIN RAIL housing			
Plug-in housing			
Function	Motor temperature monitoring relays. PTC insulated input. Automatic set-point. Short circuit detection. Latch, test and reset function (DTA02, PTA02).	Pump alternating relay. For 2 or 3 pumps. Differential or sequential mode. Automatic rotation of the pumps. Output relay managed by one independent input contact (DLA73).	Delay on operate (manual start).
<b>Input specifications</b>			
Time range			0.1 s - 1 s / 1 s - 10 s 6 s - 60 s / 60 s - 600 s 0.1 h - 1 h / 1 h - 10 h 10 h - 100 h
<b>Output specifications</b>			
	1 x SPDT relay 1 x SPST relay [DTA01]	2 x SPST relay [DLA71] [2P] 3 x SPST relay [DLA71] [3P] 3 x SPST relay [DLA73]	1 x SPDT relay [C] 2 x SPDT relays [D]
Max. load AC1	8 A / 250 VAC	5 A / 250 VAC	8 A / 250 VAC
Max. load DC12	5 A / 24 VDC	5 A / 24 VDC	5 A / 24 VDC
Electrical life	>1 x 10 <sup>5</sup> operations	>1 x 10 <sup>5</sup> operations	>1 x 10 <sup>5</sup> operations
<b>General specifications</b>			
Power supply	24-48 VAC/DC [D48] 115 VAC [115] 230 VAC [230]	24/48 VAC [B48] 115/230 VAC [B23]	24 VDC / 24-240 VAC [C] 24-240 VAC/DC [D]
Approvals/Marks	CE - UL - CSA	CE - UL - CSA	CE - UL - CSA
<b>References</b>			
	<b>DTA01C D48</b>	<b>DLA71D B48 2P</b>	<b>DAA01C M24</b>
	<b>PTA01C D48</b>	<b>DLA71T B48 3P</b>	<b>PAA01C M24</b>
	<b>DTA01C 115</b>	<b>DLA71D B23 2P</b>	<b>DAA01D M24</b>
	<b>PTA01C 115</b>	<b>DLA71T B23 3P</b>	<b>PAA01D M24</b>
	<b>DTA01C 230</b>	<b>DLA73T B23 2P</b>	
	<b>PTA01C 230</b>	<b>DLA73T B48 2P</b>	
	<b>DTA02C D48</b>		
	<b>PTA02C D48</b>		
	<b>DTA02C 115</b>		
	<b>PTA02C 115</b>		
	<b>DTA02C 230</b>		
	<b>PTA02C 230</b>		

# Timers

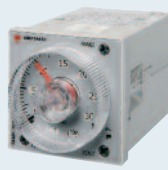
## Delay on operate

Types	DAA 51 DAA 71	FAA 01 FAA 08	HAA 08 HAA 14
			
Dimensions (mm) HxWxD DIN RAIL housing	81 x 17.5 x 67.2 [Mini-D] 81 x 35.5 x 67.2 [Mini-D]		
Plug-in housing		48 x 48 x 83.4	28 x 21.5 x 64
Function	Delay on operate (automatic start).	Delay on operate. Symmetrical recycler. Interval. One shot.	Delay on operate. Symmetrical recycler with ON or OFF first. Interval.

### Input specifications

Time range	0.1 s - 1 s 1 s - 10 s 6 s - 60 s 60 s - 600 s 0.1 h - 1 h 1 h - 10 h 10 h - 100 h	Full scale 12 0.02 - 1.2 s 0.2 - 12 s 2 - 120 s 0.2 - 12 m 2 - 120 m 0.2 - 12 h 2 - 120 h	Full scale 30 0.05 - 3 s 0.5 - 30 s 5 - 300 s 0.5 - 30 m 5 - 300 m 0.5 - 30 h 5 - 300 h	0.1 s - 1 s 1 s - 10 s 6 s - 60 s 60 s - 600 s 0.1 h - 1 h 1 h - 10 h 10 h - 100 h
------------	--	--	--	--

### Output specifications

	1 x SPDT relay [C] 1 x DPDT relay [D]	1 x DPDT relay 11-pin [01] 8-pin [08]	1 x 4PDT relay [Q] 1 x DPDT relay [D] 14-pin [14] 8-pin [08]
Max. load AC1	5 A / 250 VAC	5 A / 250 VAC	5 A / 250 VAC
Max. load DC12	5 A / 24 VDC	5 A / 24 VDC	5 A / 24 VDC
Electrical life	>1 x 10 <sup>6</sup> operations	>1 x 10 <sup>6</sup> operations	>1 x 10 <sup>6</sup> operations

### General specifications

Power supply	24 VDC / 24-240 VAC [CM24] 24-240 VAC/DC [DM24] 12-240 VAC/DC [DW24]	12-240 VAC/DC	24-240 VAC/DC
Approvals/Marks	CE - UL - CSA - RINA	CE - UL - CSA	CE - UL - CSA



### References

	DAA51C M24	FAA01D W24	HAA14Q M24
	DAA71D M24	FAA08D W24	HAA08D M24
	DAA71D W24		

# Timers

## Delay on release

## True delay on release

Types	DBA 02 PBA 02	DBA 52	D/PBB 01 D/PBB 02
			
Dimensions (mm) HxWxD			
DIN RAIL housing	80 x 22.5 x 99.5 [D]	81 x 17.5 x 67.2 [mini-D]	80 x 22.5 x 99.5 [D]
Plug-in housing	80 x 36 x 94 [P]		80 x 36 x 94 [P]
Function	Delay on release.	Delay on release.	True delay on release.

## Input specifications

Time range	0.1 s - 1 s / 1 s - 10 s 6 s - 60 s / 60 s - 600 s 0.1 h - 1 h / 1 h - 10 h 10 h - 100 h	0.1 s - 1 s / 1 s - 10 s 6 s - 60 s / 60 s - 600 s 0.1 h - 1 h / 1 h - 10 h 10 h - 100 h	D/PBB01: 0.1 s - 1 s / 1 s - 10 s 6 s - 60 s / 60 s - 600 s D/PBB02: 60 s - 600 s / 0.1 h - 1 h 1 h - 10 h
------------	---	---	---

## Output specifications

	1 x SPDT relay	1 x SPDT relay	1 x SPDT relay [C] 1 x DPDT relay [D]
Max. load AC1	8 A / 250 VAC	5 A / 250 VAC	8 A / 250 VAC
Max. load DC12	5 A / 24 VDC	5 A / 24 VDC	5 A / 24 VDC
Electrical life	>1 x 10 <sup>5</sup> operations	>1 x 10 <sup>5</sup> operations	>1 x 10 <sup>5</sup> operations

## General specifications

Power supply	24 VDC / 24-240 VAC	24 VDC / 24-240 VAC	24-240 VAC/DC [M24] 12-24 VDC [724]
Approvals/Marks	CE - UL - CSA	CE - UL - CSA	CE - UL - CSA

## References

	<b>DBA02C M24</b>	<b>DBA52C M24</b>	<b>DBB01C M24</b>
	<b>PBA02C M24</b>		<b>PBB01C M24</b>
			<b>DBB01D M24</b>
			<b>PBB01D M24</b>
			<b>DBB01C 724</b>
			<b>PBB01C 724</b>
			<b>DBB01D 724</b>
			<b>PBB01D 724</b>
			<b>DBB02C M24</b>
			<b>PBB02C M24</b>
			<b>DBB02D M24</b>
			<b>PBB02D M24</b>

# Timers

## True delay on release

## Recycler

Types	DBB 51	DCB 01 PCB 01	DCB 51
			

Dimensions (mm) HxWxD DIN RAIL housing Plug-in housing	81 x 17.5 x 67.2 [mini-D]	80 x 22.5 x 99.5 [D] 80 x 36 x 94 [P]	81 x 17.5 x 67.2 [Mini-D]
--	---------------------------	--	---------------------------

Function	True delay on release.	Asymmetrical recycler with ON and OFF time first. One shot. Two state delay on operate.	Asymmetrical recycler with ON or OFF first.
----------	------------------------	---	---

### Input specifications

Time range	1 s - 10 s [10S] 6 s - 60 s [1M] 60 s - 600 s [10M]	0.1 - 1 s / 1 - 10 s 6 - 60 s / 60 s - 600 s 0.1 h 1 h / 1 h - 10 h 10 h - 100 h	0.1 - 1 s / 1 - 10 s 6 - 60 s / 60 s - 600 s 0.1 h 1 h / 1 h - 10 h 10 h - 100 h
------------	---	---	---

### Output specifications

	1 x SPDT relay	1 x SPDT relay [C] 2 x SPDT relays [D]	1 x SPDT relay
Max. load AC1	5 A / 250 VAC	8 A / 250 VAC	5 A / 250 VAC
Max. load DC12	5 A / 24 VDC	5 A / 24 VDC	5 A / 24 VDC
Electrical life	>1 x 10 <sup>6</sup> operations	>1 x 10 <sup>6</sup> operations	>1 x 10 <sup>6</sup> operations

### General specifications





Power supply	24 VDC / 24-240 VAC	24 VDC / 24-240 VAC [C] 24-240 VAC/DC [D]	24 VDC / 24-240 VAC
Approvals/Marks	CE - UL - CSA	CE - UL - CSA	CE - UL - CSA

### References

	<b>DBB51C M24 10S</b>	<b>DCB01C M24</b>	<b>DCB51C M24</b>
	<b>DBB51C M24 1M</b>	<b>PCB01C M24</b>	
	<b>DBB51C M24 10M</b>	<b>DCB01D M24</b>	
		<b>PCB01D M24</b>	

# Timers

## Multifunction

Types	DMB 01 PMB 01	DMB 51 PMB 71	FMB 01	DMC 01 PMC 01
				
Dimensions (mm) HxWxD DIN RAIL housing	80 x 22.5 x 99.5 [D]	81 x 17.5 x 67.2 [Mini-D] [C] 81 x 35.5 x 67.2 [Mini-D] [D]	48 x 48 x 83.4	80 x 22.5 x 99.5 [D] 80 x 45 x 99.5 [D] 80 x 36 x 94 [P]
Plug-in housing	80 x 36 x 94 [P]			
Function	Multifunction: • Delay on operate - manual start • Delay on release • Interval - manual start • Symmetrical recycler • Double interval • Interval on trigger open	Multifunction: • Delay on operate - manual start • Delay on release • Interval - manual start • Symmetrical recycler • Double interval • Interval on trigger open	Multifunction: (Trigger, Gate and Reset inputs) • Delay on operate - manual start • Delay on release • Interval - manual start • Symmetrical recycler • Double interval • Interval on trigger open	Multifunction: • Delay on operate - manual start • Delay on operate - automatic and manual start • Delay on release • Interval - manual start • Interval - automatic and manual start • Interval - manual start with no time reset • Interval - automatic and manual start with no time reset

## Input specifications

Time range	0.1 s - 1 s / 1 s - 10 s 6 s - 60 s / 60 s - 600 s 0.1 h - 1 h / 1 h - 10 h 10 h - 100 h	0.1 s - 1 s / 1 s - 10 s 6 s - 60 s / 60 s - 600 s 0.1 h - 1 h / 1 h - 10 h 10 h - 100 h	Full scale: 12 0.02 - 1.2 s / 0.2 - 12 s 2 - 120 s / 0.2 - 12 m 2 - 120 m / 0.2 - 12 h 2 - 120 h Full scale: 30 0.05 - 3 s / 0.5 - 30 s 5 - 300 s / 0.5 - 30 m 5 - 300 m / 0.5 - 30 h 5 - 300 h	0.1 s - 1 s / 1 s - 10 s 6 s - 60 s / 60 s - 600 s 0.1 h - 1 h / 1 h - 10 h 10 h - 100 h
------------	---	---	--	---

## Output specifications

	1 x SPDT relay [C] 1 x DPDT relay [D]	1 x SPDT relay [C] 1 x DPDT relay [D]	1 x DPDT relay	1 x SPDT relay [C] 2 x SPDT relay [D]
Max. load AC1	8 A / 250 VAC	5 A / 250 VAC	5 A / 250 VAC	8 A / 250 VAC
Max. load DC12	5 A / 24 VDC	5 A / 24 VDC	5 A / 24 VDC	5 A / 24 VDC
Electrical life	>1 x 10 <sup>5</sup> operations	>1 x 10 <sup>5</sup> operations	>1 x 10 <sup>5</sup> operations	>1 x 10 <sup>5</sup> operations



## General specifications

Power supply	24 VDC & 24-240 VAC [C] 24-240 VAC/DC [D]	24 VDC & 24-240 VAC [M24] 12-240 VAC/DC [W24]	12-240 VAC/DC	24 VDC [724] 24/48 VAC [B48] 115/230 VAC [B23] 24 VAC [024] 115 VAC [115] 230 VAC [230]
Approvals/Marks	CE - UL - CSA - RINA	CE - UL - CSA - RINA	CE - UL - CSA	CE - UL - CSA

## References





	DMB01C M24	DMB51C M24	FMB01D W24	DMC01C xxx
	PMB01C M24	DMB51C W24		PMC01C yyy
	DMB01D M24	DMB71D M24		DMC01D xxx
	PMB01D M24	DMB71D W24		PMC01D yyy
				xxx= 724, B23, B48 yyy= 724, 024, 115, 230

# Timers

	Mini-E timers	Star delta	
Types	EAS EBS ECS	DAC 01 PAC 01	DAC 51
			
Dimensions (mm) HxWxD DIN RAIL housing	56 x 22.5 x 49 [Mini-E] 56 x 22.5 x 44 [Mini-E] [F]	80 x 22.5 x 99.5 [D]	81 x 17.5 x 67.2 [Mini-D]
Plug-in housing		80 x 36 x 94 [P]	
Function	EAS - Delay on operate (automatic start). EBS - Interval (automatic start). ECS - Symmetrical recycler (ON/OFF automatic start) thyristor output. Screw or fast-ON connection. DIN-rail or chassis mounting.	Star delta.	Star delta.
<b>Input specifications</b>			
Time range	[10S] : 0.5 s - 10 s [1M] : 0.1 m - 1 m [10M] : 1 m - 10 m	0.1 s - 1 s / 1 s - 10 s 6 s - 60 s / 60 s - 600 s	0.1 s - 1 s / 1 s - 10 s 6 s - 60 s / 60 s - 600 s
Star to delta relay (neutral centre position)		50 - 130 ms between star to delta position	50 - 130 ms between star to delta position
<b>Output specifications</b>			
	Static output 500 mA, 700 mA [F]	1 x SPDT relay (with neutral centre position)	1 x SPDT relay (with neutral centre position)
Max. load AC1		8 A / 250 VAC	5 A / 250 VAC
Max. load DC12		5 A / 24 VDC	5 A / 24 VDC
Electrical life		>1 x 10 <sup>5</sup> operations	>1 x 10 <sup>5</sup> operations
<b>General specifications</b>			
Power supply	24-230 VAC/DC [EAS] 24-230 VAC [EBS], [ECS]	24-240 VAC/DC [M24] 380-415 VAC [M40]	24-240 VAC/DC
Approvals/Marks	CE - UL - CSA	CE - UL - CSA	CE - UL - CSA
<b>References</b>			
	EAS S M23 . . .	DAC01C M24	DAC51C M24
	EAS S M23 . . . F	PAC01C M24	
	EBS S M23 . . .	DAC01C M40	
	EBS S M23 . . . F	PAC01C M40	
	ECS S M23 A . . .		
	ECS S M23 B . . .		
	ECS S M23 A . . . F		
	ECS S M23 B . . . F		
	. . . = insert code for Time Range.		

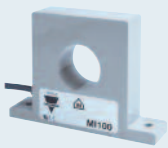
# Current transformers

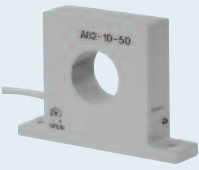
## Current transformers for monitoring relays

Types	MI	MP	A 82	E 83
				
Dimensions (mm) HxWxD	45 x 52 x 16 [5/20] 67.5 x 95 x 20 [100/500]	45 x 120 x 16 [5/20] 114 x 150 x 23 [100/500]	67.5 x 95 x 20	56 x 22.5 x 49
Function	1-phase AC. Output voltage. Cable hole.	3-phase AC. Output voltage. Cable hole.	1-phase AC. Output 0/4-20 mA DC, 0-10 VDC (A82-30). Cable hole. Led indication.	1-phase AC. Output 4-20 mA DC. Cable hole. DIN-rail mounting.

### Input specifications

Input current	0.5 - 5 AAC [5] 2 - 20 AAC [20] 10 - 100 AAC [100] 50 - 500 AAC [500]	0.5 - 5 AAC [5] 2 - 20 AAC [20] 10 - 100 AAC [100] 50 - 500 AAC [500]	0 - 25 AAC [25] 0 - 50 AAC [50] 0 - 100 AAC [100] 0 - 250 AAC [250] 0 - 500 AAC [500]	0 - 5 AAC 0 - 10 AAC 0 - 15 AAC 0 - 20 AAC 0 - 25 AAC 0 - 30 AAC 0 - 50 AAC
Max. current continuously	20 AAC [5] 50 AAC [20] 250 AAC [100] 750 AAC [500]	20 AAC [5] 50 AAC [20] 250 AAC [100] 750 AAC [500]	600 AAC	100 AAC
Dielectric voltage	6 kV ACrms	6 kV ACrms	6 kV ACrms	

### Output specifications

Output value	0.4 - 4 Vp The output voltage is proportional to the input current.	0.4 - 4 Vp The output voltage is proportional to the highest current value in the 3 conductors which are drawn through the holes of the current metering transformer.	A82 - 10: 0-20 mA DC A82 - 20: 4-20 mA DC A82 - 30: 0-10 VDC The output current (A82-10, A82-20) and voltage (A82-30) are proportional to the input current.	4 - 20 mA DC The output current is proportional to the input current.
Output tolerance	± 5% @ I <sub>n</sub>	± 5% @ I <sub>n</sub>	± 2% @ 50 Hz	± 2% @ 50 Hz
Rated insulation voltage (cable)	250 VACrms	250 VACrms	250 VACrms	

### General specifications

Cable hole diameter	10.5 mm [5/20] 27 mm [100/500]	3 x 12 mm [5/20] 3 x 27 mm [100/500]	27 mm	12 mm
Connection cable	2 m PVC 2 x 0.5 mm <sup>2</sup>	2 m PVC 2 x 0.5 mm <sup>2</sup>	A82-10, A82-30: 2m, 3x0.25 m <sup>2</sup> A82-20: 2m, 2x0.25 m <sup>2</sup>	Screw terminal 2 x 1.5 mm <sup>2</sup>
Operating temperature	-20°C to +60°C	-20°C to +60°C	-20°C to +50°C	-20°C to +50°C

### References



<b>MI 5</b>	<b>MP 3005</b>	<b>A 82-XX 25</b>	<b>E 83-20 50</b>
<b>MI 20</b>	<b>MP 3020</b>	<b>A 82-XX 50</b>	
<b>MI 100</b>	<b>MP 3100</b>	<b>A 82-XX 100</b>	
<b>MI 500</b>	<b>MP 3500</b>	<b>A 82-XX 250</b>	
		<b>A 82-XX 500</b>	

XX = 10: 0-20 mA DC  
= 20: 4-20 mA DC  
= 30: 0-10 VDC



# Current transformers

## Current Transformers

Types	TADK	TADK2	CTD 1
			

Dimensions (mm) HxWxD	115.5 x 75 x 44	115.5 x 75 x 44	86 x 56 x 42
-----------------------	-----------------	-----------------	--------------

### Input specifications

	Current transformer 1-phase AC	Current transformer 1-phase AC	Current transformer 1-phase AC
Operating frequency	48 to 62 Hz	48 to 62 Hz	48 to 62 Hz
Max. system voltage	0.72 kV	0.72 kV	0.72 kV
Rated insulation level	3 kV/1 min @ 50 Hz	3 kV/1 min @ 50 Hz	3 kV/1 min @ 50 Hz
Security factor	≤ 5	≤ 5	≤ 5

### Output specifications

Secondary current	5 A standard (1 A on request)	5 A standard (1 A on request)	5 A 1 A
-------------------	----------------------------------	----------------------------------	------------

### General specifications

Class	0.5	0.5	0.5 / 1 / 3
Bus-bar size (mm)	no (wounded primary)	25 x 5 (fixed bar)	20 x 5
Standards	IEC 60185	IEC 60185	EN 60044-1

### Primary current

	Burden (VA)				Burden (VA)				Burden (VA)			
	Class	0.5	1	3	Class	0.5	1	3	Class	0.50	1	3
Accuracy class depending on the burden output I2 nominal 1 A / 5 A	1 A	10			1 A	10			50 A		1	1.25
	5 A	10			5 A	10			60 A		1	1.25
	10 A	10			10 A	10			70 A		1.5	1.75
	15 A	10			15 A	10			75 A	1	1.25	1.75
	25 A	10			25 A	10			80 A	1.25	1.5	2
	40 A	10			40 A	10			100 A	1.5	1.75	2.25
					50 A	10			120 A	1.75	2	2.5
					60 A	10			125 A	2	2.25	2.75
					80 A	10			150 A	2.25	2.5	3
					100 A	10			160 A	2.5	2.75	3.25
					150 A	10			200 A	3	3.25	3.75
					200 A	10			250 A	4.5	4.75	5.25
					250 A	10			300 A	5	5.5	6

### References

For ordering key details, please refer to [www.productselection.net](http://www.productselection.net)

# Current transformers

## Current transformers

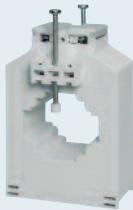
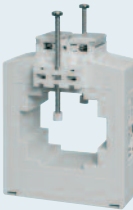
Types	CTD 2	CTD 3	CTD 4
			

Dimensions (mm) HxWxD	86 x 56 x 42	109 x 77 x 42	113 x 90 x 42
-----------------------	--------------	---------------	---------------

### Input specifications

	Current transformer 1-phase AC	Current transformer 1-phase AC	Current transformer 1-phase AC
Operating frequency	48 to 62 Hz	48 to 62 Hz	48 to 62 Hz
Max. system voltage	0.72 kV	0.72 kV	0.72 kV
Rated insulation level	3 kV/1 min @ 50 Hz	3 kV/1 min @ 50 Hz	3 kV/1 min @ 50 Hz
Security factor	≤ 5	≤ 5	≤ 5

### Output specifications

Secondary current	5 A 1 A	5 A 1 A	5 A 1 A
-------------------	------------	------------	------------

### General specifications

Class	0.5 / 1 / 3	0.5 / 1 / 3	0.5 / 1 / 3 / 5P5
Bus-bar size (mm)	32 x 5 x 30 x 10	51 x 15	64 x 20
Standards	EN 60044-1	EN 60044-1	EN 60044-1

### Primary current

	Burden (VA)			Burden (VA)			Burden (VA)					
	Class	0.5	1	3	Class	0.5	1	3	Class	0.50	1	5P5
Accuracy class depending on the burden output I2 nominal 1 A / 5 A	40 A			1.25	50 A			1.75	150 A		2.5	CI3 5
	50 A			1.5	60 A			2	200 A		3.25	CI3 6
	60 A			2	70 A			2.5	250 A	2.5	4.5	2
	70 A			2.5	75 A			3	300 A	3	4	3
	75 A		1.75	2.5	80 A			3	400 A	6	9	3
	80 A		2	2.75	100 A		2	3.5	500 A	10	12.5	4
	100 A		2.5	3	120 A		2.25	4	600 A	11	13.5	4
	120 A		2.75	3.75	125 A		2.5	4.5	700 A	12.5	15	5
	125 A	2	2.75	3.75	150 A	2.25	3	6	750 A	13	15.5	5
	150 A	3	4	5	160 A	2.5	3.5	6.5	800 A	14	16.5	5
	160 A	3	4	5	200 A	3	4.5	8.5	1000 A	17.5	20	6
	200 A	4	5	6.5	250 A	3.5	6.5	10.5	1200 A	20	22.5	6
	250 A	5.5	7	8	300 A	7	10	13	1250 A	20	22.5	6
	300 A	7	8.5	9.5	400 A	9	14	17	1500 A	27.5	30	8
	400 A	12	13.5	14.5	500 A	14	18	21	1600 A	27.5	30	8
	500 A	14	15.5	16.5	600 A	17	21	24				
600 A	17.5	19	20	700 A	22	26	29					
				750 A	24	28	31					
				800 A	25	29	32					

### References

For ordering key details, please refer to [www.productselection.net](http://www.productselection.net)

# Current transformers

## Current transformers

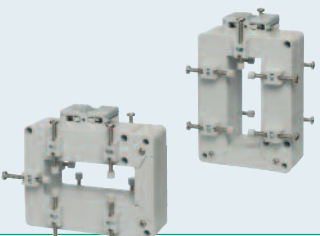
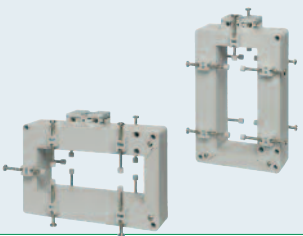
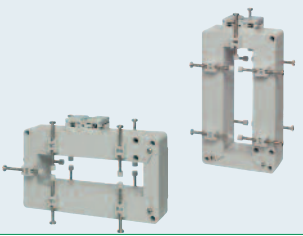
Types	CTD 8V CTD 8H	CTD 9V CTD 9H	CTD 10V CTD 10H
			
Dimensions (mm) HxWxD	132.9 x 87 x 60	177.9 x 91.7 x 60	177.9 x 106.7 x 60

### Input specifications

	Current transformer 1-phase AC	Current transformer 1-phase AC	Current transformer 1-phase AC
Operating frequency	48 to 62 Hz	48 to 62 Hz	48 to 62 Hz
Max. system voltage	0.72 kV	0.72 kV	0.72 kV
Rated insulation level	3 kV/1 min @ 50 Hz	3 kV/1 min @ 50 Hz	3 kV/1 min @ 50 Hz
Security factor	≤ 5	≤ 5	≤ 5

### Output specifications

Secondary current	5 A 1 A	5 A 1 A	5 A 1 A
-------------------	------------	------------	------------

### General specifications

Class	0.5 / 1 / 3	0.5 / 1 / 3	0.5 / 1 / 3
Bus-bar size (mm)	81 x 31	125 x 36	126 x 51
Standards	EN 60044-1	EN 60044-1	EN 60044-1

### Primary current

Accuracy class depending on the burden output I <sub>2</sub> nominal 1 A / 5 A	Burden (VA)			Burden (VA)			Burden (VA)											
	Class	0.5	1	3	Class	0.5	1	3	Class	0.50	1	3						
150 A				2	400 A			3	6	400 A			1	7	10			
200 A				4	500 A			2	4	8	500 A			3	10	14		
250 A				5	600 A			4	6	10	600 A			5	12	17		
300 A				2	6	700 A			4	8	10	700 A			8	15	20	
400 A				3	5	8	750 A			4	8	10	750 A			10	15	20
500 A				5	7	10	800 A			4	8	10	800 A			10	15	20
600 A				6	10	12	1000 A			6	10	13	1000 A			12	20	25
700 A				6	10	12	1200 A			8	12	15	1200 A			15	25	30
750 A				8	12	15	1250 A			8	12	15	1250 A			15	25	30
800 A				8	12	15	1500 A			10	15	18	1500 A			20	30	40
1000 A				10	15	20	1600 A			10	15	18	1600 A			20	30	40
1200 A				12	15	20	2000 A			15	20	24	2000 A			25	40	50
1250 A				12	15	20	2500 A			20	25	30	2500 A			30	50	60
1500 A				15	20	25	3000 A			25	30	35	3000 A			30	50	60
1600 A				15	20	25	3200 A			25	30	35	3200 A			30	50	60
2000 A				20	25	30												
2500 A				25	30	40												

### References

For ordering key details, please refer to [www.productselection.net](http://www.productselection.net)

# Current transformers

## Split core current transformers

### Types

#### CTD 5S

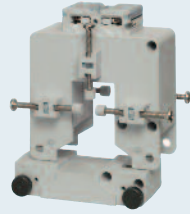

#### CTD 6S

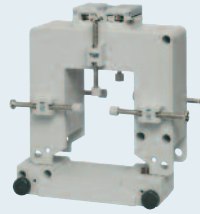

#### CTD 8S

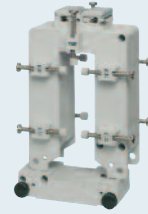

Dimensions (mm) HxWxD

93.9 x 83 x 60

113.9 x 107 x 60

132.9 x 87 x 60

### Input specifications

	Split core current transformer 1-phase AC	Split core current transformer 1-phase AC	Split core current transformer 1-phase AC
Operating frequency	58 to 62 Hz	58 to 62 Hz	58 to 62 Hz
Max. system voltage	0.72 kV	0.72 kV	0.72 kV
Rated insulation level	3 kV <sub>RMS</sub> , 50 Hz, 1min	3 kV <sub>RMS</sub> , 50 Hz, 1min	3 kV <sub>RMS</sub> , 50 Hz, 1min
Security factor	≤ 5	≤ 5	≤ 5

### Output specifications

Secondary current	5 A 1 A	5 A 1 A	5 A 1 A
-------------------	------------	------------	------------

### General specifications

Class	1	1	1
Bus-bar size (mm)	27 x 32	52 x 51	81 x 31
Standards	EN 60044-1	EN 60044-1	EN 60044-1

### Primary current



Class	Burden (VA)		Class	Burden (VA)		Class	Burden (VA)	
	1	3		1	3		1	3
100 A		1.5	150 A		1.5	150 A		1.5
125 A	1.5	1.5	200 A	1.5	2	200 A		1.5
150 A	1.5	2.5	250 A	1.5	3.75	250 A		2
200 A	1.5	5	300 A	1.5	5	300 A		2
250 A	1.5	5	400 A	2.5	5	400 A	3	5
300 A	2.5	7.5	500 A	5	10	500 A	5	7
400 A	5	10	600 A	7.5	15	600 A	6	10
			700 A	7.5	15	700 A	6	10
			750 A	7.5	15	750 A	8	12
			800 A	10	15	800 A	8	12
			1000 A	10	15	1000 A	10	15
						1200 A	12	15
						1250 A	12	15
						1500 A	15	20
						1600 A	15	20
						2000 A	20	25
						2500 A	25	30

### References

For ordering key details, please refer to [www.productselection.net](http://www.productselection.net)

# Current transformers

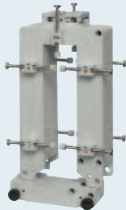
## Split core current transformers

Types	CTD 9S	CTD 10S	SCT 166/205
			

Dimensions (mm) HxWxD	177.9 x 91.7 x 60	177.9 x 106.7 x 60	328 x 50 x 166
-----------------------	-------------------	--------------------	----------------

### Input specifications

	Split core current transformer 1-phase AC	Split core current transformer 1-phase AC	Split core current transformer 1-phase AC
Operating frequency	58 to 62 Hz	58 to 62 Hz	50 to 60 Hz
Max. system voltage	0.72 kV	0.72 kV	0.72 kV
Rated insulation level	3 kV <sub>RMS</sub> , 50 Hz, 1min	3 kV <sub>RMS</sub> , 50 Hz, 1min	4 kV <sub>RMS</sub> , 50 Hz, 1min
Security factor	≤ 5	≤ 5	5, 10

### Output specifications

Secondary current	5 A 1 A	5 A 1 A	5 A standard (1 A on request)
-------------------	------------	------------	----------------------------------

### General specifications

Class	1	1	1/ 3/ 0.5 (on request)
Bus-bar size (mm)	126 x 36	126 x 51	62 x 205
Standards	EN 60044-1	EN 60044-1	BS3938, EN60044-1, DIN42600

### Primary current

	Burden (VA)			Burden (VA)			Burden (VA)			
	Class	1	3	Class	1	3	Class	0.5	1	3
400 A			3	400 A	1	7	1000 A	-	5	7.5
500 A	2	4		500 A	3	10	1200 A	1.5	5/7.5	10
600 A	4	6		600 A	5	12	1250 A	1.5	1.5/2.5/10	5/15
700 A	4	8		700 A	8	15	1500 A	2.5	5/10	15
750 A	4	8		750 A	10	15	2000 A	5	5/10/15	20
800 A	4	8		800 A	10	15	2500 A	5	5/10/15	20
1000 A	6	10		1000 A	12	20	3000 A	5/10/15	5/10/15/20	30
1200 A	8	12		1200 A	15	25	4000 A	5/10/15	5/10/15/20	30
1250 A	8	12		1250 A	15	25	5000 A	5/10/15/30	5/10/15/30	
1500 A	10	15		1500 A	20	30	6000 A	5/10/15/30	5/10/15/30	
1600 A	10	15		1600 A	20	30				
2000 A	15	20		2000 A	25	40				
2500 A	20	25		2500 A	30	50				
3000 A	25	30		3000 A	30	50				
3200 A	25	30		3200 A	30	50				

E.g.: 5/10 5= standard 10= on request



### References

For ordering key details, please refer to [www.productselection.net](http://www.productselection.net)

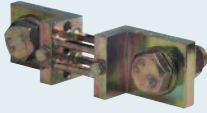
# Current sensor and shunt



	Active current sensor	Shunt
<b>Types</b>	<b>ROG 400</b>	<b>DER</b>
		
Dimensions (mm) HxWxD	54 x 29 x 17	
<b>Input specifications</b>		
	Split core AC current sensor 1-phase AC	Shunt for DC current
Operating frequency	45 to 65 Hz	Continuous current
Rated insulation level	6 kV <sub>RMS</sub> , 1min	
<b>Output specifications</b>		
Secondary current	4 to 20 mA DC	
<b>General specifications</b>		
Class		0.5
Bus-bar size (mm)	40	
Standards		DIN 43703
<b>Primary current</b>		
Accuracy class depending on the burden output I <sub>2</sub> nominal 1 A / 5 A	400 AAC	Measuring range for current 1 to 10000 A Secondary: 60 mV (150 mV or other on request)
<b>References</b>		
	<b>ROG 400</b>	For ordering key details, please refer to <a href="http://www.productselection.net">www.productselection.net</a>

# Accessories and transducer

	Serial converter		Ethernet gateway
Types	SIU-PC2	SIU-PC3	SIU-TCP2
			
Dimensions (mm) HxWxD	Front: 100 x 67	Front: 60 x 37.5	Front: 78 x 65
Function	RS422/RS485 to RS232 converter	RS422/RS485 to USB converter	Ethernet to RS232/485 Gateway
<b>Port 1</b>			
Port Connections	RS232 9-pole, female	USB type A	Ethernet, 10/100Mbps RJ45
Baud rate	Max 230400 Baud	Max 961.6 kBaud	Max 230400 Baud
<b>Port 2</b>			
Port Connections	RS422, RS485 2-wire and 4-wire communication	RS232, RS485 2-wire communication	RS232, RS485 2-wire and 4-wire communication
<b>General specifications</b>			
Power supply	12 to 30 VDC Suggested adapter: SPD12-101 (120 to 240VAC/DC)	Self supplied by USB port	9 to 30 VDC AD5V1A: AC/DC power supply adapter (on request)
Approvals/Marks	CE - FCC	CE - FCC	CE
<b>References</b>			
	SIU PC2	SIU PC3	SIU TCP2
	SIU PC2I (2kV insulated)		



# Digital panel meters

## Ammeters, voltmeters and frequency meters

Types	DI3 DIN	DI3 72	LDI 3
			
Dimensions (mm) HxWxD	89 x 52.5 x 58.5	72 x 72 x 75.5	48 x 96 x 83
Function	3-digit meter. 1-phase AC, DC. Voltmeter, ammeter frequency meter.	Microprocessor based indicator. AC/DC Ammeter, Voltmeter. Freq. meter 3-digit display red LED. Height: 14.2 mm.	Microprocessor based indicator. AC/DC Ammeter, Voltmeter. Freq. meter 3-digit display.
<b>Input specifications</b>			
Range code	1 A/100 VAC [AV1] 5 A/500 VAC [AV5] 1 A/60 mV/100 V /500 VDC [AV6] 1 Hz to 1000 Hz [F1K]	[AV1]: 1 AAC / 100 VAC [AV5]: 5 AAC / 500 VAC [AV6]: 1 ADC / 60 mV / 100 V / 500 VDC	[AV1]: 1 AAC/100 VAC [AV5]: 5 AAC/500 VAC [AV6]: 1 ADC/60 mV /100 V/500 VDC [F1K]: 1 to 1000Hz
Accuracy	0.5% FS (0.1% FS frequency meter)	±0.5% FS	±0.5% FS (±0.3% FS frequency meter)
Indication	Max. 999 [AV1/AV5], 000 [AV1/AV5] Min. -99 [AV6]	999 [AV1/AV5], 000 [AV1/AV5] -99 [AV6]	999 [AV1/AV5]: 000, [AV6]: -99
Range selection/decimal point pos.	Selectable by DIP-switch	Selectable by DIP-switch	Selectable by DIP-switch
Display refresh time	1 time/s	1 time/s	1 time/s
<b>General specifications</b>			
Power supply	24 VAC [A] 48 VAC [B] 115 VAC [C] 230 VAC [D]	24 VAC [A], 48 VAC [B], 115 VAC [C], 230 VAC [D]	230 VAC [D], 24 [A], 48 [B], 115 [C] VAC
Option			IP65[IX], tropicalization [XT]
Safety Standards	EN 61010-1, IEC 61010-1, VDE0411	EN 61010-1, IEC 61010-1, VDE0411	EN 61010-1, IEC 61010-1, VDE0411
Approvals/Marks	CE	CE - c CSA us	CE - c CSA us
<b>References</b>			
For ordering key details, please refer to <a href="http://www.productselection.net">www.productselection.net</a>			





# Digital panel meters

	Ammeters and voltmeters		Thermometer and ohmmeter
Types	LDI 35 AV0	LDI 35 AV2	LDI 35 CF
			
Dimensions (mm) HxWxD	48 x 96 x 83	48 x 96 x 83	48 x 96 x 83
Function	Microprocessor based indicator/controller, AC/DC ammeter, voltmeter, 3½-digit or 3-digit + dummy zero display	Microprocessor based indicator/controller, AC/DC ammeter, voltmeter, 3½-digit or 3-digit + dummy zero display	Microprocessor based indicator/controller, Temperature resistance Measur. in C° or F° 3½-digit or 3-digit + dummy zero display
<b>Input specifications</b>			
Range code	Current: 2 mA DC, 20 mA DC Voltage: 200 mV DC, 20 VDC, 200 VDC [AV0]	Current: 2 A AC/DC, 5 A AC/DC, Voltage: 200 V AC/DC, 500 V AC/DC [AV2]	Pt100, Ni100 [CFX]; Pt1000[CFP]; TC-J-LK-S-T [CFX/CFP]; 200.0Ω [CFX]; 2000Ω [CFP]
Accuracy	±0.3% FS	DC: ±0.3% FS, AC: ±0.5% FS	TC, PT100/1000, resistance ±0.3% FS Ni 100 ±0.5% FS
Indication	Max. 3½-dgt: 1999, 3+0-dgt: 9990, Min. 3½-dgt: -1999, 3+0-dgt: -1990,	3½-dgt: 1999, 3+0-dgt: 9990, 3½-dgt: -1999 (DC), 0 (AC), 3+0-dgt: -1990 (DC), 0 (AC)	Depending on range and type of the temperature probe
Resistance			0 to 200 Ω (2000 Ω)
Range election/decimal point pos.	Programmable	Programmable	Programmable
Display refresh time	4 times/s	4 times/s	4 times/s
<b>Functions</b>			
	Password protection. Scaling factor. Diagnostics. Digital filter programm. Max. data hold.	Password protection. Scaling factor. Diagnostics. Digital filter programm. Max. data hold.	Password protection. Scaling factor. Diagnostics. Digital filter programm. Max. data hold.
<b>Output specifications</b>			
Setpoints	1 optional alarm [1] 5 A / 250 VAC/DC. Excit. output 40 mA / 15 VDC [AX]	1 optional alarm [1] 5 A / 250 VAC/DC. Excit. output 40 mA / 15 VDC [AX]	1 optional alarm [1] 5 A / 250 VAC/DC. Excit. output 40 mA / 15 VDC [AX]
<b>General specifications</b>			
Power supply	120 [E], 230 [D], 240[F], 24 [A], 48 [B], 115 [C] VAC, 9-32 [3] VDC, 40-150 [6] VDC	120 [E], 230 [D], 240[F], 24 [A], 48 [B], 115 [C] VAC, 9-32 [3] VDC, 40-150 [6] VDC,	120 [E], 230 [D], 240[F], 24 [A], 48 [B], 115 [C] VAC, 9-32 [3] VDC, 40-150 [6] VDC,
Option	IP65[IX], excit. out [AX], tropicalization [XT]	IP65[IX], excit. out [AX], tropicalization [XT]	IP65[IX], excit. out [AX], tropicalization [XT]
Safety Standards	EN 61010-1, IEC 61010-1, VDE0411	EN 61010-1, IEC 61010-1, VDE0411	EN 61010-1, IEC 61010-1, VDE0411
Approvals/Marks	CE - c CSA us	CE - c CSA us	CE - c CSA us
<b>References</b>			
For ordering key details, please refer to <a href="http://www.productselection.net">www.productselection.net</a>			



# Digital panel meters

## Ammeters and voltmeters



Types	LDM 30	LDM 35 H	LDM 40
			
Dimensions (mm) HxWxD	48 x 96 x 83	48 x 96 x 83	48 x 96 x 83
Function	3-digit + dummy 0 $\mu$ P-based indicator, red LED display.	3 1/2-digit $\mu$ P-based indicator and controller, 3 1/2-DGT or 3-DGT + dummy 0 red LED display.	4-digit $\mu$ P-based indicator and controller
<b>Input specifications</b>			
Range code	1A/100VAC [AV1]; 5A/500VAC [AV5]	(0.2-2-20 mA, 0.2-2-20 V) [LSE]; (0.2- 2-5 A, 20-200-500 V) [HSX]; DC and AC TRMS	(0.2-2-20 mA, 0.2-2-20 V) [LSE]; (0.2- 2-5 A, 20-200-500 V) [HSX]; DC and AC TRMS
Accuracy	$\pm 0.5\%$ FS, $\pm 1$ DGT	DC: $\pm(0.3\%$ RDG + 3DGT) AC: $\pm(0.5\%$ RDG + 3DGT)	DC: $\pm(0.1\%$ RDG + 2DGT) AC: $\pm(0.3\%$ RDG + 2DGT)
Indication	Max. 9990 Min. 000		9999, 0 (AC) -9999 (DC) 4-digit LED red
Range election/decimal point pos.	Selectable by dipswitch	Programmable	Programmable
Display refresh time	2 times/s	5 times/s	5 times/s
<b>Functions</b>			
		Signal/display scaling. Digital filter. Peak and valley.	Signal/display scaling. Digital filter. Peak and valley.
<b>Output specifications</b>			
		Up to 2 Alarm relay, [1-2]	Up to 2 Alarm relay, [1-2], Analogue 0 to 20mA, 0 to 10V [AV], RS485
<b>General specifications</b>			
Power supply	24/48V AC [B], 115/230V AC [D]	90 to 260V AC/DC [H], 18 to 60V AC/DC [L]	90 to 260V AC/DC [H], 18 to 60V AC/DC [L]
Option	Tropicalization [XT], IP65 [IX]	Tropicalization [TX]	Tropicalization [TX]
Safety Standards	EN61010-1 IEC61010-1		EN61010-1 IEC61010-1
Approvals/Marks	CE - c UR us - c CSA us	CE - c UR us - c CSA us	CE - c UR us - c CSA us pending
<b>References</b>			
For ordering key details, please refer to <a href="http://www.productselection.net">www.productselection.net</a>			

# Digital panel meters



## Modular meter and conditioner

Types	UDM 35	UDM40/USC	UDM 60
			
Dimensions (mm) HxWxD	48 x 96 x 105	44 x 113 x 107 (USC) 48 x 96 x 105 (UDM40)	48 x 96 x 105
Function	MODULAR Microprocessor-based indicator/controller AC/DC Ammeter/Voltmeter/resistance/ temperature measurement	MODULAR Microprocessor-based indicator/controller AC/DC Ammeter/Voltmeter/resistance/ temperature measurement	MODULAR 6-DGT $\mu$ P-based controller
<b>Input specifications</b>			
Range code	0.2-2-20mA DC/AC 0.2-2-20V DC/AC [LSX] + AUX 13VDC [LSE] or 25VDC [LSF]; 0.2-2-5A DC/AC; 20-200-500V DC/AC [HSX]; TC: J-K-S-T-E, Pt100-250-500- 1000 [TRX]; 0.02-0.2-2-20 k $\Omega$ [TRX]	0.2-2-20mA DC/AC 0.2-2-20V DC/AC [LSX] + AUX 13VDC [LSE] or 25VDC [LSF]; 0.2-2-5A DC/AC; 20-200-500V DC/AC [HSX]; TC: J-K-S-T-E, Pt100-250-500- 1000 [TRX]; 0.02-0.2-2-20 k $\Omega$ [TRX]	Speed, frequency, rate, period, totalizer 0.001Hz to 50Hz for DC signal [TF1] 0.001Hz to 50Hz for AC signal [TF2]
Accuracy	0.1% RDG	0.1% RDG	$\pm(0.001\%RDG + 3DGT)$
Indication	Max. 1999, Min. 0 (AC) -1999 (DC) 3 1/2-digit LED red	Max. 9999, Min. 0 (AC) -9999 (DC) 4-digit LED. Colours: red, green, orange	Max. 9 999 999 Min. 0 6-DGT, LCD backlighted display
Range election/decimal	Programmable	Programmable	Programmable
Display refresh time	5 times/s	5 times/s	
<b>Functions</b>			
	Password protection. Scaling factor. Min Max data storage. Programmable digital filter. Range selection. Programmable via PC.	Password protection. Scaling factor. Min Max data storage. 16 linearization points. Programm. digital filter. Range selection. Programmable via PC.	Signal/display scaling. Analogue output scaling. Digital filter. Peak and valley. Linearization. Combination of the inputs according to predefined functions. Pulse metering and totalizing.
<b>Output specifications</b>			
Setpoints	Analogue 0 to 20mA, 0 to 10V [AV], Serial RS485 [SX], Serial RS232 [SY], Single relay output [R1], Dual relay output [R2], Dual relay + dual open coll. output [R4], Four relay output [RS]	Analogue 0 to 20mA, 0 to 10V [AV], Serial RS485 [SX], Serial RS232 [SY], Single relay output [R1], Dual relay output [R2], Dual relay + dual open coll. output [R4], Four relay output [RS]	Analogue 0 to 20 mA, 0 to 10V [AV] Serial RS485 [SX], Serial RS232 [SY], Single relay output [R1], Dual relay output [R2], Dual relay + dual open coll. output [R4], Four relay output [RS]
<b>General Specifications</b>			
Power supply	90 to 260 VAC/DC [H], 18 to 60 VAC/DC [L]	90 to 260 VAC/DC [H], 18 to 60 VAC/DC [L]	90 to 260 AC/DC [H], 18 to 60 VAC/DC [L]
Option	Tropicalization [TX]	Tropicalization [TX]	Tropicalization [TX]
Safety Standards	EN 61010-1, IEC 61010-1	EN 61010-1, IEC 61010-1	EN 61010-1, IEC 61010-1
Approvals/Marks	CE - c UR us - c CSA us	CE - c UR us - c CSA us	CE - c UR us - c CSA us pending
<b>References</b>			
For ordering key details, please refer to <a href="http://www.productselection.net">www.productselection.net</a>			



# Energy management

	Energy meter	Energy analyzer	Energy meter
Types	EM10 DIN	EM11 DIN	EM21 72D
			
Dimensions (mm) HxWxD	90 x 18 x 67	90 x 18 x 67	72 x 72 x 65
Description	1-DIN module	1-DIN module	
Function	1-phase energy meter kWh	1-phase energy analyzer $V_{LN}$ , A, Hz, W, $W_{dmd}$ , var, PF, kWh, kvarh. TRMS method	3-phase energy analyzer with double mounting capability, panel and DIN rail, W, var, PF, Phase-sequence, VLL, VLN, A TRMS method
<b>Input specifications</b>			
Range code	120 VAC [AV7] 230 VAC [AV8] Ib: 5 A, I <sub>max</sub> : 32 AAC; 1-phase	120 VAC [AV7] 230 VAC [AV8] Ib: 5 A, I <sub>max</sub> : 32 AAC; 1-phase	120/230 VAC, 400 VAC In: 5 A; I <sub>max</sub> : 6 A 3-phase
Accuracy		±0.5% RDG (V, A)	
Active energy	Class 1 (EN62053-21) +	Class 1 (EN62053-21) +	Class 1 (EN62053-21) +
Reactive energy	Class B (EN50470-3)	Class B (EN50470-3) Class 2 (EN62053-23)	Class B (EN50470-3) Class 2 (EN62053-23)
Display	5+1 DGT (energy), LCD	4 DGT (inst. variables) 5+1 DGT (energies), LCD	3 DGT (inst. variables) 6+1 DGT (energies), LCD
<b>Output specifications</b>			
Out 1 (Pulse)	1-open collector	1-open collector	1 static opto-mosfet
Out 1 (Alarm)		1-relay	None
Out 2 (Serial communication)			None
Inputs			RS485 (2-wire, Modbus) M-BUS by means of VMU-B
<b>General specifications</b>			
Power supply	Self power supply [X]	Self power supply [X]	Self power supply
Approvals/Marks	CE - MID certification	CE - MID certification	CE
<b>References</b>			
For ordering key details, please refer to <a href="http://www.productselection.net">www.productselection.net</a>			

# Energy management

	Multifunction meter	Energy meter	Energy analyzer
Types	WM10 DIN	EM23 DIN	EM24 DIN
			
Dimensions (mm) HxWxD	90 x 71 x 64.5	90 x 71 x 64.5	90 x 71 x 65
Description			4 DIN modules
Function	3-phase multifunction meter W, var, PF, Hz, A, VLN, VLL TRMS method	3-phase energy analyzer W, var, A, kWh, kvarh TRMS method	3-phase energy analyzer Sys: VLL, VLN, , var, VA, Wdmd, W, VA dmd, Hz, kWh, kvarh, hour counter, gas and water Max: Admd, Wdmd, VA dmd. Single-phase: VLL, VLN, A, W, var, VA, PF, Admd, kWh, kvarh. TRMS method
<b>Input specifications</b>			
Range code	400 VLLAC Ib: 10 A; I <sub>max</sub> 65 A 3-phase	400 VLLAC Ib: 10 A; I <sub>max</sub> 65 A 3-phase	120/208VL-L [AV6]; 400VL-L [AV5] In: 1/5A, I <sub>max</sub> : 10AAC; 120/208VL-L [AV0]; 230VL-L [AV2] 400VL-L [AV9] Ib: 10A, I <sub>max</sub> : 64AAC; 3-phase
Accuracy			±0.5% RDG (V, A)
Active energy	Class 1 (EN62053-21) +	Class 1 (EN62053-21) +	Class 1 (EN62053-21) +
Reactive energy	Class B (EN50470-3) Class 2 (EN62053-23)	Class B (EN50470-3) Class 2 (EN62053-23)	Class B (EN50470-3) Class 2 (EN62053-23)
Display	3 x 3 DGT (inst. variables)	3 x 3 DGT (inst. variables) 6+1 DGT (energies) LCD	3x4 DGT (inst. variables) 8 DGT (energies), LCD
<b>Output specifications</b>			
Out 1 (Pulse)	None	1-open collector	2-open collector/relay
Out 1 (Alarm)	None	None	2-relay/open collector
Out 2 (Serial communication)	None	None	RS485 (2-wire) M-BUS by means of VMU-B
Inputs	None	None	3 digital input
<b>General specifications</b>			
Power supply	Self power supply	Self power supply	Self power supply [X]. Auxiliary power supply: 18 to 60VAC/DC [L], 115/230VAC [D], according to the model
Approvals/Marks	CE	CE - MID certification	CE - MID certification
<b>References</b>			
For ordering key details, please refer to <a href="http://www.productselection.net">www.productselection.net</a>			

# Energy management

	Energy meters		Power analyzer
Types	EM3-DIN	EM4-DIN	WM22 DIN
			
Dimensions (mm) HxWxD	90 x 162.5 x 63	90 x 162.5 x 63	90 x 162.5 x 63
Description	MODULAR	MODULAR	MODULAR
Function	2-phase, 3-phase unbalanced 3 or 4 wires energy meter. Direct connection up to 100 A. 6+1 digits electromechanical display.	3-phase energy meter. Direct connection up to 100 A. Back-lighted LCD display. 31/2 digits instantaneous variables read out, 8+ 7½ dgt energy read out. Measurement of system and phase variables, energy by timeperiods, m3 H2O and m3 GAS.	3-phase power analyzer. Direct connection up to 100 A. Back-lighted LCD display. 4 x 31/2 digits instantaneous variables read out, 7½ digits energy read out. Measurement of system and phase variables. Measurement of THD.
<b>Input specifications</b>			
Range code	208 V <sub>L-L</sub> [AV8], 220 V <sub>L-L</sub> [AV2], 400 V <sub>L-L</sub> [AV9], 660 V <sub>L-L</sub> [AV3] / 20(00) AAC. 3-phase unbalanced load [3]	100 V <sub>L-L</sub> [AV6], 208 V <sub>L-L</sub> [AV4], 400 V <sub>L-L</sub> [AV5], 660 V <sub>L-L</sub> [AV7] 5(10) AAC; 208 V <sub>L-L</sub> [AV0] [AV8 self p.s.], 220 V <sub>L-L</sub> [AV2], 400 V <sub>L-L</sub> [AV1] [AV9 self p.s.], 660 V <sub>L-L</sub> [AV3] 20(100) AAC;	100 V <sub>L-L</sub> [AV6], 208 V <sub>L-L</sub> [AV4], 400 V <sub>L-L</sub> [AV5], 660 V <sub>L-L</sub> [AV7] 5(10) AAC; 208 V <sub>L-L</sub> [AV0], 400 V <sub>L-L</sub> [AV1], 220 V <sub>L-L</sub> [AV2] 660 V <sub>L-L</sub> [AV3] 20(100) AAC
Accuracy			±0.5% RDG (A,V)
Active energy	Class 2: (EN61036)	Class 1: (EN61036)	Class 1: (EN61036)
Reactive energy	Class 3: (EN61268)	Class 2: (EN61268)	Class 2: (EN61268)
Display	6+1 digits (electromechanical)	3½-digit backlighted LCD (8-digit for energy)	1000 samples /s @ 50Hz
<b>Output specifications</b>			
Out 1 (Pulse)	Dual pulse outputs (NPN transistor) [O]	Dual pulse output module (NPN trans.) [O]	Dual pulse output module (NPN trans.) [O]
Out 1 (Alarm)		1 alarm output module [O] (NPN trans.) 30 VDC/100 mA Max.	1 alarm + 1 pulse output module [O] (NPN tr) 30 VDC/100 mA Max.
Out 2 (Serial communication)		RS422/485 serial port [SO]	1 analogue output : 0 to 20 mADC [A1], or 0 to 10 VDC [V1]
Inputs		2 digital inputs module [D]	RS422/485 serial port [SO]
<b>General specifications</b>			
Power supply	Self power supply [X]: 400 VAC, 208 VAC V <sub>L-L</sub> , Auxiliary power supply: 230 VAC [D], 115 VAC [C]	Self power supply: [X] 400 VAC, 208 VAC, 220 VAC V <sub>L-L</sub> , Auxiliary power supply: 230[D], 115[C], 48[B], 24 [A]VAC, 18 to 60 VDC [4], 77 to 143 VDC [5]	Self power supply: [X] 400 VAC 208 VAC V <sub>L-L</sub> , Auxiliary power supply: 230[D], 115[C], 48[B], 24 [A]VAC, 18 to 60 [4], 77 to 143 VDC [5]
Approvals/Marks	CE	CE	CE
<b>References</b>			
For ordering key details, please refer to <a href="http://www.productselection.net">www.productselection.net</a>			

# Energy management

## Multifunction meter

## Power analyzers

Types	WM12-DIN	WM14 DIN	WM14 Advanced
			

Dimensions (mm) HxWxD	90 x 107.8 x 64.5	90 x 107.8 x 64.5	90 x 107.8 x 64.5
Function	3-phase multifunction power indicator. System: $V_{LL}$ , $V_{LN}$ , An, VA, $VA_{dmd}$ , $W_{dmd}$ , W, var, PF, Hz. Max: A, $W_{dmd}$ . Single phase: $V_{LL}$ , $V_{LN}$ , A, VA, W, var, PF	3-phase power analyzer. System: $V_{LL}$ , An, PF, W, var, VA, $W_{dmd}$ , $VA_{dmd}$ , Hz, kWh, kvarh, hour meter; Max: A, $A_{dmd}$ , $W_{dmd}$ ; Single phase: $V_{LL}$ , $V_{LN}$ , A, $A_{dmd}$ , PF, W, var, VA.	3-phase power analyzer. System: $V_{LL}$ , $V_{LN}$ , An, PF, W, var, VA, $W_{dmd}$ , $VA_{dmd}$ , Hz, kWh, kvarh, hour meter; Max: $W_{dmd}$ , $VA_{dmd}$ . Single phase: $V_{LL}$ , $V_{LN}$ , A, $A_{dmd}$ , PF, W, var, VA, THD (A,V); Max: $V_{LN}$ , A, $A_{dmd}$ , W. Min: $V_{LN}$ , A, PF.

## Input specifications

Range code	400/660 $V_{L-L}/5(6)$ AAC [AV5] 100/208 $V_{L-L}/5(6)$ AAC [AV6]	400/660 $V_{L-L}/5(6)$ AAC [AV5] 100/208 $V_{L-L}/5(6)$ AAC [AV6]	400/660 $V_{L-L}/5(6)$ AAC [AV5], 100/208 $V_{L-L}/5(6)$ AAC [AV6]
Accuracy	$\pm 0.5\%$ FS (V, A)	0.5 FS (V, A), 1 (kWh), 2 (kvarh)	0.5 FS (V, A), 1 (kWh), 2 (kvarh)
Display	3x3-digit LED	3x3-digit, LED 8+1-digit (energies)	3x3-digit, LED 8+digit (energies)
Display refresh time	1.5 times/s	1.5 times/s	5 times/s (2 times/s FFT on)

## Output specifications

Serial communication output	RS485 port (on request) [S]	RS485 port (on request) [S]	RS485 port (on request) [S]
Alarm output			2 (relays) with PLC-type control function on 16 variables (AND/OR) [R]
Pulse output			2 (open collector) [O]

## General specifications

Power supply	24 VAC [A], 48 VAC [B], 115 VAC [C], 230 VAC [D], 18 to 60 VDC [3]	24 VAC [A] 48 VAC [B] 115 VAC [C] 230 VAC [D] 18 to 60 VDC [3]	18 to 60 VAC/DC [L], 90 to 260 VAC/DC [H]
Approvals/Marks	CE - cURus	CE - cURus - cCSAus	CE - cURus
Note			Advanced version [AX]

## References

For ordering key details, please refer to [www.productselection.net](http://www.productselection.net)

# Energy management

## Multifunction meter

## Power analyzers

### Types

### WM12 96

### WM14 96 Basic/Profibus

### WM14 96 Advanced



Dimensions (mm) HxWxD

96 x 96 x 46

96 x 96 x 46

96 x 96 x 46

Function

3-phase multifunction indicator.  
System:  $V_{LL}$ ,  $V_{LN}$ , A, An, VA,  $W_{dmd}$ , W,  $W_{dmd}$ , var, PF, Hz.  
Max: A,  $W_{dmd}$   
Single phase:  $V_{LL}$ ,  $V_{LN}$ , A, VA, W, var, PF

3-phase power analyzer.  
System:  $V_{LL}$ , An, PF, W, var, VA,  $W_{dmd}$ ,  $VA_{dmd}$ , Hz, kWh, kvarh, hour meter;  
Max: A,  $A_{dmd}$ ,  $W_{dmd}$ ;  
Single phase:  $V_{LL}$ ,  $V_{LN}$ , A,  $A_{dmd}$ , PF, W, var, VA.

3-phase power analyzer.  
System:  $V_{LL}$ ,  $V_{LN}$ , An, PF, W, var, VA,  $W_{dmd}$ ,  $VA_{dmd}$ , Hz, kWh, kvarh, hour meter;  
Max:  $W_{dmd}$ ,  $VA_{dmd}$ .  
Single phase:  $V_{LL}$ ,  $V_{LN}$ , A,  $A_{dmd}$ , PF, W, var, VA, THD (A,V);  
Max:  $V_{LN}$ , A,  $A_{dmd}$ , W.  
Min:  $V_{LN}$ , A, PF.

## Input specifications

Range code	400/660 $V_{L-L}$ / 5(6) AAC [AV5], 100/208 $V_{L-L}$ / 5(6) AAC [AV6]	400/660 $V_{L-L}$ / 5(6) AAC [AV5], 100/208 $V_{L-L}$ / 5(6) AAC [AV6]	400/660 $V_{L-L}$ / 5(6) AAC [AV5], 100/208 $V_{L-L}$ / 5(6) AAC [AV6]
Accuracy	0.5 FS (V, A)	0.5 FS (V, A) 1 (kWh) 2 (kvarh)	0.5 FS (V, A), 1 (kWh), 2 (kvarh)
Display	3x3-digit, LED	3x3-digit, LED 8+1-digit (energies)	3x3-digit, LED 8+1-digit (energies)
Display refresh time	1.5 times/s	1.5 times/s	5 times/s (2 times/ FFT on)

## Output specifications

Serial communication output	RS 485 port (on request) [S]	RS 485 port (on request) [S] Profibus DP port [DG] (on request) 	RS422/485 (on request) [S1]
Alarm output			2 (relays) with PLC-type control function on 16 variables (AND/OR) [R]
Pulse output			2 (open collector) [O]

## General specifications

Power supply	24 VAC [A], 48 VAC [B], 115 VAC [C], 230 VAC [D], 18 to 60 VDC [3]	24 VAC [A], 48 VAC [B], 115 VAC [C], 230 VAC [D], 18 to 60 VDC [3], 90 to 260 AC/DC [H] DG version only	18 to 60VAC/DC [L], 90 to 260VAC/DC [H]
Approvals/Marks	CE - cURus - cCSAus	CE - cURus (no DG version)	CE - cURus Advanced version [AX]

## References



For ordering key details, please refer to [www.productselection.net](http://www.productselection.net)



# Energy management

## Energy analyzer

## Modular power quality analyzers

Types	EM26 96	WM30 96	WM40 96
			
Dimensions (mm) HxWxD	96 x 96 x 61	96 x 96 x 50	96 x 96 x 50
Description		MODULAR	MODULAR
Function	<p>3-phase energy analyzer            Sys: <math>V_{LL}</math>, <math>V_{LN}</math>, An, var, VA, W, <math>W_{dmd}</math>, <math>VA_{dmd}</math>, VA, Hz, %THD-V, %THD-A, kWh, kvarh, hour counter, gas and water            Max: <math>A_{dmd}</math>, <math>W_{dmd}</math>, <math>VA_{dmd}</math>.            Single-phase: <math>V_{LL}</math>, <math>V_{LN}</math>, A, W, var, VA, PF, <math>A_{dmd}</math>. kWh, kvarh; TRMS method</p>	<p>3-phase power quality analyzer            System: <math>V_{LN}</math>, <math>V_L</math>, VA, W, var, PF, Hz, THD total/partial kWh and kvarh            Single phase: <math>V_{LN}</math>, <math>V_{LL}</math>, VA, AL, An, W, var, PF, THD;            Phase-sequence-asymmetryloss</p>	<p>3-phase power quality analyzer System:  <math>V_{LN}</math>, <math>V_L</math>, VA, W, var, PF, Hz, THD.            Total/partial kWh and kvarh (multi-tariff), K-factor Single phase: <math>V_{LN}</math>, <math>V_L</math>, VA, AL An (calculated or measured), W, var, PF, THD, TDD; Phasesequence-asymmetry-loss            Load profile, event stamping, data logger, utility and hour counters</p>
<b>Input specifications</b>			
Range code	120/208 $V_{L-L}$ [AV6], 400/660 $V_{L-L}$ [AV5] In: 1/5A, I <sub>max</sub> : 10AAC 3-phase unbal. load	400/690 $V_{LL}$ AC1(2)A [AV4] 400/690 $V_{LL}$ AC5(6)A [AV5] 100/208 $V_{LL}$ AC5(6)A [AV6] 100/208 $V_{LL}$ AC1(2)A [AV7]	400/690 $V_{LL}$ AC1(2)A [AV4] 400/690 $V_{LL}$ AC5(6)A [AV5] 100/208 $V_{LL}$ AC5(6)A [AV6] 100/208 $V_{LL}$ AC1(2)A [AV7]
Accuracy	±0.5% RDG (V, A) 1 (kWh), 2 (kvarh)	±0.2% RDG (V, A) C (kWh), 2 (kvarh)	±0.2% RDG (V, A) Class C (kWh), EN50470-3 Class 2 (kvarh), EN62053-23
Display	3x4-digit (inst. variables) 8-digit (energies) LCD	4x4-digit backligh. LCD 9+1-digit (energies).	4x4-digit backligh. LCD 9+1-digit (energies).
Display refresh time	1.5 times/s	≤ 100 ms	≤ 100 ms
<b>Output specifications</b>			
Serial communication output	RS485 (2-wire) [S1]	RS485 port/ RS232 port + RTC [S1]	RS 485 port/ RS232 port + RTC [S1]. Optical port (ANSI type 2)
Internet/Ethernet port		Ethernet port [E2], BACNet-IP [BI]	Ethernet port [E2], BACNet-IP [BI]
Alarm output	2-relay [R2]/ open collector [O3]	Up to 4 freely configuration virtual alarms	Up to 16 freely configuration virtual alarms
Pulse output	3-open collector [O3]/relay [B2]	Up to 2 digital output modules	Up to 8 digital outputs
Digital input	3 digital inputs [I3]		Up to 6 digital inputs
Analogue output		Up to 2 analogue output modules	Up to 4 analogue outputs
<b>General specifications</b>			
Power supply	18 to 60VAC/DC [L] 90 to 260VAC/DC [H]	18 to 60 VAC/DC [L] 90 to 260 VAC/DC [H]	18 to 60 VAC/DC [L] 90 to 260 VAC/DC [H]
Approvals/Marks	CE - cULus (only H),	CE - cULus "Listed"	CE - cULus "Listed"
<b>References</b>			
For ordering key details, please refer to <a href="http://www.productselection.net">www.productselection.net</a>			

# Energy management

## Modular power quality analyzer

## Modular power quality analyzer/transducers

### Types

### WM3 96

### WM5 96/PQT H

### PQT 90



Dimensions (mm) HxWxD	96 x 96 x 124	96 x 96 x 124 (WM5-96) 90 x 90 x 140 (PQT-H)	90 x 90 x 140
Description	MODULAR	MODULAR	MODULAR
Function	3-phase power quality analyzer System: $V_{LN}$ , $V_{LL}$ , An, VA, $VA_{dmd}$ , W, $W_{dmd}$ , var, PF, Hz, THD, total/partial kWh, kvarh (4 tariff) Single phase: $V_{LN}$ , $V_{LL}$ , A, W, var, PF, THD	Smart power quality analyzer (WM5-96), transducer (PQT-H). Sys: $V_{LN}$ , $V_{LL}$ , An, W, var, VA, PF, Hz, kWh, kvarh, Single-phase: $V_{LN}$ , $V_{LL}$ , A, W, var, VA, PF, THD-V, THD-A. THD and single H up to the 63rd H (V, A).	3-phase power quality transducer. 32 bit $\mu$ P based. Alarm outputs, SMS messages. Measurement of all instantaneous variables. Energy, water and gas metering. 2MB memory+Real time clock (on request).

### Input specifications

Range code	433 VAC-1/5 AAC [AV5] 690 VAC-1/5 AAC [AV7]	120/208VL-L [AV6], 400/690VL-L [AV5] In: 1/5A, I <sub>max</sub> : 10AAC	240/415 VAC-1/5 AAC [AV5], 400/690 VAC-1/5 AAC [AV7]
Accuracy	$\pm 0.5\%$ RDG (V, A)	$\pm 0.2\%$ RDG (V, A)	Class 0.5 (A, V)
Active energy	1 (kWh)	Class 0.5 (EN62053-22)	Class 1 (EN61036)
Reactive energy	2 (kvarh)	Class 2 (EN62053-23)	Class 2 (EN61260)
Display	4x4-digit backligh. LCD 4x9-digit (energies).	WM5: 4x4-digit backlighted LCD WM5: 4x9-digit (energy)	
Sampling Rate	10 times /s	10 times/s	10 times/s

### Output specifications

Serial communication output	RS 422/485 port RS232 port + RTC	RS422/485, RS232+RTC modules. Optical port (ANSI C12.18/Modbus)	RS 422/485 port, RS232 port + RTC+2MB data module
Internet/Ethernet port		Internet/Ethernet comm. with WEB server capability [E2]	Internet/Ethernet comm. with WEB server capability [E1]
Alarm output	Up to 2 single/dual open collector or relay modules	Up to 16, by: single/dual or quadruple open collector or relay modules	Up to 2 single/dual open collector or relay modules
Pulse output	Up to 2 single/dual open collector or relay modules	Up to 16, by: single dual or quadruple open collector or relay modules	Up to 2 single/dual open collector or relay modules
Digital input	Up to 3 digital inputs	Up to 12 ( $W_{dmd}$ , $VA_{dmd}$ sync.; tariff, contact status reading)	Up to 6 digital inputs
Analogue output	Up to 2 single/dual analogue output modules	Up to 8, by single/dual (mA/V) output modules	Up to 2 single/dual analogue output modules



### General specifications

Power supply	18 to 60 VAC/DC [L] 90 to 260 VAC/DC [H]	18 to 60 VAC/DC [L], 90 to 260 VAC/DC [H]	18 to 60 VAC/DC [L], 90 to 260 VAC/DC [H]
Approvals/Marks	CE - cURus - CSA	CE - cURus - CSA	CE - cURus - CSA

### References



For ordering key details, please refer to [www.productselection.net](http://www.productselection.net)

# Energy management

		Compact power transducers		Transducer
Types	CPT DIN	CPT DIN Advanced	CVT DIN	
				
Dimensions (mm) HxWxD	45 x 83.5 x 98.5	45 x 83.5 x 98.5	89 x 71.5 x 58.5	
Description	3-phase compact power transducer.	3-phase compact power transducer.	Single phase transducer	
Function	4-digit data format instantaneous variable, 8+1-digit format energy variables, 5+2-digit data format hours. TRMS method. Sys: $V_{LL}$ , An, PF, W, var, VA, $W_{dmd}$ , $VA_{dmd}$ , Hz, kWh, kvarh, hour meter; Max: $W_{dmd}$ ; Single-ph: $V_{LL}$ , $V_{LN}$ , A, $A_{dmd}$ , PF, W, var, VA.	4-digit data format instantaneous variable, 8+1-digit format energies, 5+2-digit format hours. TRMS method. Sys: $V_{LL}$ , $V_{LN}$ , An, PF, W, var, VA, $W_{dmd}$ , $VA_{dmd}$ , Hz, kWh, kvarh, hour; Max: $W_{dmd}$ , $VA_{dmd}$ . Sing. ph: $V_{LL}$ , $V_{LN}$ , A, $A_{dmd}$ , PF, W, var, VA, THD, (A,V); Max: $V_{LN}$ , A, $A_{dmd}$ , W. Min: $V_{LN}$ , A, PF.	1-phase AC, DC. Measurements V, A, Hz.	
<b>Input specifications</b>				
Range code	120/208VAC [AV6], 400/690VAC [AV5], 1AAC and 5AAC	120/208VAC [AV6], 400/690VAC [AV5], 1AAC and 5AAC	1 A/100 VAC [AV1], 60 mVDC/ 10 VDC [AV2], 5 A/100 VAC [AV4], 5 A/500 VAC [AV5], 200VDC/ 1ADC [AV6], 45 to 55Hz [F1], 55 to 65Hz [F2], 350 to 450Hz [F3]	
Accuracy	±0.5% RDG (A,V)	±0.5% RDG (A,V)	0.5% FS	
Active energy	kWh: class 1	kWh: class 1 (EN62053-21)		
Reactive energy	kvarh: class 2	kvarh: class 2 (EN62053-23)		
Sampling Rate	1.5 times/s	1.5 times/s		
<b>Output specifications</b>				
Serial communication	RS422/485 [S1], RS232 [S2]	RS422/485 [S1], RS232 [S2]		
Alarm output		2 (relays) with PLC-type control function on 16 variables (AND/OR) [R2]		
Pulse output		2 (open collector) [O2]		
Analogue output		Up to 3: 20mA [A1-3], 10VDC [V1-3]	0 to 20 mA [1], 4 to 20 mA [2], 0 to 10 V [3], 0 to ±1 V [4]	
<b>General specifications</b>				
Power supply	18 to 60VAC/DC [L], 90 to 260VAC/DC [H]	18 to 60VAC/DC [L], 90 to 260VAC/DC [H]	24 VAC [A], 48 VAC [B], 115 VAC [C], 230 VAC [D]	
Approvals/Marks	CE - cURus - CSA	CE - cURus - CSA	CE	
Note	Basic version [BX]	Advanced version [AX]		
<b>References</b>				
For ordering key details, please refer to <a href="http://www.productselection.net">www.productselection.net</a>				

# Energy management

## DC energy analyzers

Types	VMU-E	VMU-X
		
Dimensions (mm) HxWxD	1-DIN module	1-DIN module
Description	DC energy analyzer: V, A, W, kWh	Power supply module for VMU-E unit
<b>Input specifications</b>		
Range code	400 VDC 20 A [AV00] (up 1000 A with external shunt)	
Accuracy	±0.5% RDG (V, A)	
Energy	Class 1	
Display	6 DGT, LCD, h 7mm	
<b>Output specifications</b>		
Out 1 (Pulse)	1 opto-mosfet	
Out 1 (Alarm)	1 opto-mosfet	
Serial communication	RS485	
<b>General specifications</b>		
Power supply	Self power supply through VMU-X unit [X]	38 to 265 VAC/DC [X]
Approvals/Marks	CE	CE
<b>References</b>		
For ordering key details, please refer to <a href="http://www.productselection.net">www.productselection.net</a>		

# Counters

## Types

### Electromechanical counters

#### EMCT46/EMCT47

#### E2CT4

#### E1CT4

#### ECH4



Version	Micro	Mini	Standard	Combination time and energy meter
Dimensions (mm) HxWxD	13.8x25x35.2 20x30x36.2	24x48x53.8	24x48x49	48x48x38

### Technical data

Number of digit	6/7	5	6	7/8
Reset	no	yes	no	no
Digit height, visible (mm)	4 x 1.7 / 4 x 1.2	4 x 1.7	4 x 1.7	4 x 1.7
Panel cut-out (mm)	e.g. 27x 14	45 x 22 / 31 x 20	45 x 22 / 31 x 20	46 x 46 X Ø50.5
Mounting type	Panel / PCB	Panel / base mount / PCB	Panel / base mount / PCB	Panel / DIN-rail
Max. protection	up to IP 65	IP 41	IP 41	IP 52 front side
Pulse voltage min./max.	1.5 to 24VDC	24 to 230VAC 12 to 24VDC	24 to 230VAC 12 to 24VDC	0 to 260VAC 0 to 260VDC
Max. count frequency	10 Hz	10 Hz	10 Hz	10 Hz
Min. power consumption	70 mW	130 mW	50 mW	1 W / 3 V

### References

EMCT46xxxxxx  
EMCT47xxxxxx

E2CT4xxxxxx

E1CT4xxxxxx

ECH4

### Electronic counters

## Type

#### FKA

#### DCT86

#### DMF861

#### DMF862



Version	LCD-Panel mount	LCD-Panel mount	LCD-Panel mount	LCD-Panel mount
Dimensions (mm) HxWxD	DIN 48 X 24	DIN 48 X 24	DIN 48 X 24	DIN 48 X 24

### Function

Totaliser	yes			
Pulse counter		yes	yes	2 pulse counters, Pulse counter and timer,
Position display for encoders			yes	Pulse and frequency meter or 2 timers
Frequency meter/Tachometer			yes	
Timer			yes	

### Technical data

Number of digit	8	6	6	6
Time range	manual/electric	manual/electric	manual/electric	manual/electric
Digit height, visible (mm)	8	8	8	8
Panel cut-out(mm)	45 x 22	45 x 22	45 x 22	45 x 22
Max. protection	IP 65 front side	IP 65 front side	IP 65 front side	IP 65 front side
Min. power consumption (W/VA)	12000	60000	60000	60000
Power supply	Lithium battery	10 to 30 VDC	10 to 30 VDC	10 to 30 VDC
Count inputs	NPN/PNP 10 to 260 VAC/DC	NPN/PNP	NPN/PNP	NPN/PNP

### References

FKAxxxxxx

NI-DCT86xxxxxx

NI-DMF861xxxxxx

NI-DMF862xxxxxx

# Counters

## Types

## Digital multifunction

### DMF1461

### DMF1462



Version	LED - Panel mount	LED - Panel mount
Dimensions (mm) HxWxD	DIN 96 x 48	DIN 96 x 48

## Function

Pulse counter	Yes	2 pulse counters, Pulse counter and timer, Pulse and frequency meter or 2 timers
Position display for encoders	Yes	
Frequency meter/Tachometer	Yes	
Timer	Yes	

## Technical data

Number of digit	6	6
Reset	manual / electric	manual / electric
Preset	-	-
Digit height, visible (mm)	14	14
Panel cut-out (mm)	92x45	92x45
Max. protection	IP65 front side	IP65 front side
Max. count frequency (Hz)	60000	60000
Supply voltage	90...260 Vac / 10...30 Vdc	90...260 Vac / 10...30 Vdc
Count inputs	Schmitt-Trigger	Schmitt-Trigger

## References

### DMF1461xx0

### DMF1462xx0

## Hour meter electromechanical

## Type

### E1HM4

### E2HM4

### E2HM35

### E1HM35



Version	Panel mount	Panel mount	Panel mount	DIN rail
Dimensions (mm) HxWxD	DIN 48x24 - DIN 25x53	DIN 48x48	Ø71.1x37.3	90x36x66

## Technical data

Number of digit	7/8	7/8	6	7
Time range	0.01~99999.99h	0.01~99999.99h	0.01~99999.99h	0.01~99999.99h
Digit height, visible (mm)	4	4	3.5	3.5
Panel cut-out(mm)	45x22 / 50x25	46x46	Ø56.7	-
Max. protection	IP65 front side	IP65 front side	IP65 front side	IP65 front side
Min. power consumption (W/VA)	0.5 / 1.2	0.5 / 1.2	0.8 / 0.4	1 / 2.5
Voltage range	20...264 Vac 10...130Vdc / 24 Vdc	20...264 Vac - 100...130Vac 10...30 Vdc	115...230 Vac 10...80Vdc	230 Vac 10...27Vdc

## References





### E1HM4xxxxxx

### E2HM4xxxxxx

### E2HM35xxxxxx

### E1HM35xxxxxx

# Counters

Types	Hour meter electronic LCD		Electronic time preset counters	
	FSA01	FSA02	FKC01	DMF61 / DMF62
				
Version	LCD panel mount	LCD panel mount	LCD panel mount	LCD panel mount
Dimensions (mm) HxWxD	DIN 24 x 48	DIN 24 x 48	DIN 48 x 48	DIN 48 x 48
<b>Technical data</b>				
Number of digit	7	8	6 x 2 lines	2 x 6
Time range	0.01h; h.min	0.01h; h.min		
Max. Count frequency (Hz)			10.000	s. min. h or hh.mm.ss
Preset			1	61: 1 / 62: 2
Reset	manual	manual	electronic	electronic
Digit height, visible (mm)	8	8		
Panel cut-out (mm)	45 x 22	45 x 22	45 x 45	45 x 45
Mounting type	Panel mount	Panel mount	Panel mount	Panel mount
Max. protection	IP 65 front side	IP 65 front side	IP 65 front side	IP 65 front side
Power supply	Lithium battery (>8years)	Lithium battery (>8years)	90 to 260 VAC 11 to 30 VDC	90 to 260 VAC 11 to 30 VDC
Output			Relay or Optocoupler	Relay or Optocoupler
Input			2 count inputs, gate, reset and key lock input	2 count inputs, gate, reset, lock, MPI, 4 optional inputs
<b>References</b>				
	FSA01xxxxxx	FSA02xxxxxx	FKC0101xxxx	DMF6101xxxx0 DMF6201xxxx0

# PID controllers

## PID controller – PDI series

Types	PDI 380	PDI 390	PDI 408	PDI 409
				

Dimensions (mm) HxWxD	75 x 33 x 64	75 x 33 x 64	48 x 48 x 98	48 x 48 x 98
Function	Single display digital controller. Up to 4 configurable set points. Configurable multi input. ON/OFF, single/double action PID or Neutral Zone control. Fast Autotuning and Selftuning. Up to 2 configurable outputs (relay, SSR). Soft Start and LbA functions. Led shift index. Multi-level parameters programming, password protected. Programming KEY	Dual display digital controller. Up to 4 configurable set points. Configurable multi input. ON/OFF, single/double action PID or Neutral Zone control. Fast Autotuning and Selftuning. Up to 2 configurable outputs (relay, SSR). Soft Start and LbA functions. Multi-level parameters programming, password protected. Programming KEY.	Single display digital controller. Up to 4 configurable set points. Configurable multi input. ON/OFF, single/double action PID or Neutral Zone control. Fast Autotuning and Selftuning. Up to 3 configurable outputs (relay, SSR). Soft Start and LbA functions. Led shift index. Multilevel parameters programming, password protected. Programming KEY.	Dual display digital controller. Up to 4 configurable set points. Configurable multi input. ON/OFF, single/double action PID or Neutral Zone control. Fast Autotuning and Selftuning. Up to 3 configurable outputs (relay, SSR). Soft Start and LbA functions. Multi-level parameters programming, password protected. Programming KEY.

### Input specifications

Overall accuracy	±0.5% f.s., ±1% TC-S	±0.5% f.s., ±1% TC-S	±0.5% f.s., ±1% TC-S	±0.5% f.s., ±1% TC-S
Input signal	TC (J, K, S, I R), Pt100, mV [C] TC (J, K, S, I R), PTC, NTC, mV [E] 0/4-20 mA [I] 0/1-5 0/2-10 VDC [V]	TC (J, K, S, I R), Pt100, mV [C] TC (J, K, S, I R), PTC, NTC, mV [E] 0/4-20 mA [I] 0/1-5 0/2-10 VDC [V]	TC (J, K, S, IR), PTC, NTC, mV [E] TC (J, K, S, IR), PT100, mV [C] 0/4-20 mA [I] 0-1V, 0/1-5V, 0/2-10V [V]	TC (J, K, S, I R), PTC, NTC, mV [E] TC (J, K, S, I R), PT100, mV [C] 0/4-20 mA [I] 0-1V, 0/1-5V, 0/2-10V [V]
Sampling rate	8 per second	8 per second	8 per second	8 per second
Display	4 digit 7-segment LED, h 12mm	4+4 digit 7-segment LED, h 7mm	4 digit 7-segment LED, h 12mm	4+4 digit 7-segment LED, h 7mm

### Output specifications

Output 1	Relay [R], 8mA/8VDC for SSR [O] No [X]	Relay [R], 8mA/8VDC for SSR [O] No [X]	Relay [R], 8mA/8VDC for SSR [O] No [X]	Relay [R], 8mA/8VDC for SSR [O] No [X]
Output 2	Relay [R], 8mA/8VDC for SSR [O]	Relay [R], 8mA/8VDC for SSR [O]	Relay [R], 8mA/8VDC for SSR [O] No [X]	Relay [R], 8mA/8VDC for SSR [O]
Output 3			Relay [R], 8mA/8VDC for SSR [O]	Relay [R], 8mA/8VDC for SSR [O]

### Others

Power supply	12VAC / DC [F] 24VAC / DC [L] 100-240VAC [H]	12VAC / DC [F] 24VAC / DC [L] 100-240VAC [H]	24VAC / DC [L] 100-240VAC [H]	24VAC / DC [L] 100-240VAC [H]
Approvals	CE - cURus	CE - cURus	CE - cURus	CE - cURus

### References

For ordering key details, please refer to [www.productselection.net](http://www.productselection.net)



# PID controllers

## PID controller – PDI series

Types	PDI 420	PDI 430	PDI 720
			

Dimensions (mm) HxWxD	48 x 48 x 98	48 x 48 x 98	72 x 72 x 97
Function	Dual display digital controller. Up to 4 configurable set points. Universal input. ON/OFF, single/ double action PID or Neutral Zone control. Fast Autotuning and Selftuning. Up to 4 configurable outputs (relay, SSR). Soft Start and LbA functions. RS485 communication. CT input for HB alarm. Multi-level parameters programming, password protected. Programming KEY.	Dual display digital controller. Up to 4 configurable set points. Universal input. ON/OFF, single/double action PID or Neutral Zone control. Fast Autotuning and Selftuning. Up to 4 configurable outputs (relay, SSR or 2 normalized analogue signal outputs). Input signal retransmission. Motorized actuators control. Soft Start and LbA functions. RS485 communication. CT input for HB alarm. Additional dig. in. Multi-level parameters programming, password protected. Programming KEY.	Single display digital controller. Up to 4 configurable set points. Configurable multi input. ON/OFF, single/double action PID or Neutral Zone control. Fast Autotuning and Selftuning. Up to 3 configurable outputs (relay, SSR). Soft Start and LbA functions. Led shift index. RS485 communication. Additional digital input. Multi-level parameters programming, password protected. Programming KEY.

### Input specifications

Overall accuracy	±0.15% f.s.	±0.15% f.s.	±0.5% f.s., ±1% TC-S
Input signal	Pt100, TC (J, K, S, IR), PTC, NTC, mv, V, mA	Pt100, TC (J, K, S, B, C, E, L, N, R, T, IR), PTC, NTC, mv, V, mA (1 Programmable digital input)	Pt100, TC (J, K, S, IR), mV [C] PTC, NTC, mV, TC (J, K, S, IR) [E] 0/4-20 mA [I], 0/1-5V, 0/2-10V [V]
Sampling rate	8 x per second	8 x per second	8 x per second
Display	4+4 digit 7-segment LED, h 7 mm	4+4 digit 7-segment LED, h 7mm	4 digit 7-segment LED, h 14 mm

### Output specifications

Output 1	Relay [R], 7mA/14VDC for SSR [O]	Relay [R], 7mA/14VDC for SSR [O] 0/4-20mA [C], 0/2-10V [V]	Relay [R], 8mA/8VDC for SSR [O]
Output 2	No [X] Relay [R], 7mA/14VDC for SSR [O]	No [X] Relay [R], 7mA/14VDC for SSR [O] 0/4-20mA [C], 0/2-10V [V]	No [X] Relay [R], 8mA/8VDC for SSR [O]
Output 3	No [X] Relay [R], 7mA/14VDC for SSR [O]	No [X] Relay [R], 7mA/14VDC for SSR [O]	No [X] Relay [R], 8mA/8VDC for SSR [O]
Output 4	No [X] Relay [R], 7mA/14VDC for SSR [O]	No [X] Relay [R], 7mA/14VDC for SSR [O]	

### Options

Serial Communication	No [X] RS485 [S]		No [X] RS485 [S]
Serial Communication and/or digital input		No [X] RS485 [S] RS485 + DI [I]	No [X] DI [I]
Heater Break Alarm	No [X] CT input [H]	No [X] CT input [H]	

### Others

Power supply	24 VAC / DC [L] 100-240 VAC [H]	24 VAC / DC [L] 100-240 VAC [H]	24 VAC / DC [L] 100-240 VAC [H]
Approvals	CE - cURus	CE - cURus	CE - cURus

### References

For ordering key details, please refer to [www.productselection.net](http://www.productselection.net)

# Switching power supplies

## Single phase switching power supplies

Types	5 / 10 / 18W	30 / 60W	90 / 100W
			

Dimensions (mm) HxWxD	90 x 22.5 x 115	90 x 40.5 x 115	90 x 54 x 114
-----------------------	-----------------	-----------------	---------------

### Output specifications

Voltage	5 VDC 15 VDC 12 VDC 24 VDC	12 VDC 24 VDC 48 VDC	12 VDC 24 VDC 48 VDC
Current SPD 5W	1 A 340 mA 420 mA 210 mA		
Current SPD 10W	2 A 670 mA 840 mA 420 mA		
Current SPD 18W	3 A 1.2 A 1.5 A 750 mA		
Current SPD 30W		2.5 A 1.25 A 625 mA	
Current SPD 60W		5 A 2.5 A 1.25 A	
Current SPD 90W			3.8 A
Current SPD 100W			8.4 A 4.2 A 2.1 A
Line regulation	±1%	±2%	±0.5%
Load regulation	±2%	±2%	±1%
Efficiency	75% 77% 77% 77%	86% 89% 89%	85%

### Input specifications

Voltage range	Multi voltage: 90 to 265 VAC or 120 to 370 VDC	Multi voltage: 90 to 265VAC or 120 to 370 VDC	Multi voltage: 90 to 264 VAC or 120 to 375 VDC
Frequency range	47 to 63 Hz	47 to 63 Hz	47 to 63 Hz
PFC			0.7

### General specifications

Ambient temperature	-25°C to +71°C	-25°C to +71°C	-25°C to +71°C
Storage	-25°C to +85°C	-25°C to +85°C	-25°C to +85°C
Derating (>60°C)	3 % /°C	2.5 % /°C	2.5 % /°C
Approvals/Marks	UL - cUL - TÜV - CE - Class I DIV2	UL - cUL - TÜV - CE - Class I DIV2	UL - cUL - TÜV - CE - Class I DIV2
Installation	DIN Rail	DIN Rail	DIN Rail
Connection	Screw terminals/Spring terminals (B)	Screw terminals/Spring terminals (B)	Screw terminals/Spring terminals (B)

### Main features

	Adjustable output voltage Internal noise filter Short circuit protection Overload protection (110-135%)	Adjustable output voltage Internal noise filter Short circuit protection Overload protection (110-135 %) Output "Power ready" signal VDC (only model 24 VDC)	Adjustable output voltage Internal noise filter Short circuit protection Overload protection (102-108%), PFC. Overvoltage protection (102-106%). Output "Power ready" signal VDC.
LED indicator for "power on"	Yes	Yes	Yes
LED indicator for DC "too low"	Yes	No - SPD24 with transistor output	Yes with relay output

### References

5 VDC			
Screw terminals	SPD05051 / SPD05101 SPD05181		
Spring terminals	SPD05051B / SPD05101B SPD05181B		
12 VDC			
Screw terminals	SPD12051 / SPD12101 SPD12181	SPD12301 SPD12601	SPD121001
Spring terminals	SPD12051B / SPD12101B SPD12181B	SPD12301B SPD12601B	
24 VDC			
Screw terminals	SPD24051 / SPD24101 SPD24181	SPD24301 SPD24601	SPD24901L SPD241001
Spring terminals	SPD24051B / SPD24101B SPD24181B	SPD24301B SPD24601B	
48 VDC			
Screw terminals		SPD48301 SPD48601	SPD481001
Spring terminals		SPD48301B SPD48601B	

# Switching power supplies

## Single phase switching power supplies

Types	120W - 120W(N)	240 W	300 W	480 W
				

Dimensions (mm) HxWxD	125 x 63.5 x 126	125 x 83 x 126	125 x 83 x 126	125 x 175 x 123
-----------------------	------------------	----------------	----------------	-----------------

### Output specifications

Voltage	12 VDC 24 VDC 48 VDC	24 VDC 48 VDC	24 VDC 48 VDC	24 VDC 48 VDC
Current	10 A 5 A 2.5 A	10 A 5 A	12.5A 6.25A	20A 10A
Line regulation	±1%	±1%	±0.5%	±0.5%
Load regulation	±1%	±1%	±1%	±0.5%
Efficiency	84% 86% 87%	89% 90%	89% 90%	89% 90%

### Input specifications

Voltage range	By switch: 93 to 132 VAC (autoselect on "N" model), 186 to 264 VAC 210 to 370 VDC	Autoselect: 93 to 132VAC, 186 to 264VAC, 210 to 370VDC	Autoselect: 90 to 264 VAC, 210 to 375 VDC	Autoselect: 93 to 132 VAC, 186 to 264 VAC, 210 to 370 VDC
Frequency range	47 to 63 Hz	47 to 63 Hz	47 to 63 Hz	47 to 63 Hz
PFC	0.7	0.7	0.75	0.99

### General specifications

Ambient temperature	-25°C to +71°C	-25°C to +71°C	-25°C to +71°C	-25°C to +71°C
Storage	-25°C to +85°C	-25°C to +85°C	-25°C to +85°C	-25°C to +85°C
Derating (>60°C)	2.5 % /°C	2.5 % /°C	2.5 % /°C	2.5 % /°C > 56°C
Approvals/Marks	UL - cUL - TÜV - CE - ClassI DIV2	UL - cUL - TÜV - CE - ClassI DIV2	UL - cUL - TÜV - CE - ClassI DIV2	UL - cUL - TÜV - CE - ClassI DIV2
Installation	DIN Rail	DIN Rail	DIN Rail	DIN Rail
Connection	Screw terminals/ Spring terminals (B)	Screw terminals/ Spring terminals (B)	Screw terminals/ Spring terminals (B)	Screw terminals/ Spring terminals (B)

### Main features

	Adjustable output voltage. Internal noise filter. Short circuit protection. Overload protection (110-145%). Parallel connection up to 3 supplies and PFC function on (N) model only.	Adjustable output voltage. Internal noise filter. Short circuit protection. Overload protection (110-145%) Parallel connection up to 3 supplies standard. PFC function integrated.	Parallel function, PFC and Output ready	Adjustable output voltage. Internal noise filter. Short circuit protection. Overload protection (120-140%) Parallel connection up to 3 supplies standard. PFC function integrated.
LED indicator for "power on"	Yes	Yes	Yes, 24V with output ready	Yes
LED indicator for DC "too low"	Yes - with relay output (SPD24 only)	Yes - with relay output (SPD24 only)	Yes	Yes - with relay output (SPD24 only)

### References

#### 12 VDC

Screw terminals	SPD121201 SPD121201N			
Detach. screw terminals	SPD121201B SPD121201BN			

#### 24 VDC





Screw terminals	SPD241201 SPD241201N	SPD242401	SPD243001	SPD244801
Detach. screw terminals	SPD241201B SPD241201BN	SPD242401B	SPD243001B	SPD244801B

#### 48 VDC



Screw terminals	SPD481201 SPD481201N	SPD482401	SPD483001	SPD484801
Detach. screw terminals	SPD481201B SPD481201BN	SPD482401B	SPD483001B	SPD484801B

# Switching power supplies

## Three phase switching power supplies





Types	SPD 120 W 3ph	SPD 240 W 3ph	SPD 480 W 3ph	SPD 960 W 3ph
				
Dimensions (mm) HxWxD	123.6 x 74.3 x 112	123.6 x 89.0 x 110.7	125 x 175 x 125	125.9 x 275.8 x 118.2
<b>Output specifications</b>				
Voltage	12 VDC 24 VDC	24 VDC 48 VDC	24 VDC 48 VDC	24 VDC 48 VDC
Current	10 A 5 A	10 A 5 A	20 A 10 A	40 A 20 A
Line regulation	±1%	±1%	±0.5%	±1%
Load regulation	±1%	±1%	±0.5%	±1%
Efficiency	88% 89%	90% 91%	90% 91%	92% 93%
<b>Input specifications</b>				
Voltage range	340 to 575 VAC 480 to 820 VDC	340 to 575 VAC 480 to 820 VDC	340 to 575 VAC 480 to 820 VDC	340 to 575 VAC 480 to 820 VDC
Frequency range	47 to 63Hz	47 to 63Hz	47 to 63Hz	47 to 63Hz
PFC	0.6	0.6	0.7	0.7
<b>General specifications</b>				
Ambient temperature	-25°C to +71°C	-25°C to +71°C	-25°C to +71°C	-25°C to +71°C
Storage	-25°C to +85°C	-25°C to +85°C	-25°C to +85°C	-25°C to +85°C
Derating (>60°C)	2.5 % /°C	2.5 % /°C	2.5 % /°C > 56°C	2.5 % /°C > 56°C
Approvals/Marks	UL - cUL - TÜV - CE	UL - cUL - TÜV - CE	UL - cUL - TÜV - CE	UL - cUL - TÜV - CE
Installation	DIN Rail	DIN Rail	DIN Rail	DIN Rail
Connection	Screw terminals	Screw terminals	Screw terminals / Detach conn.	Screw terminals
<b>Main features</b>				
	Can be used as Bi or Three phase, Parallel function and PFC.	Can be used as Bi or Three phase, Parallel function and PFC.	Can be used as Bi or Three phase, Parallel function and PFC.	Can be used as Bi or Three phase. Active parallel function and PFC.
LED indicator for "power on"	Yes, 24 V with output ready	Yes, 24 V with output ready	Yes, 24 V with output ready	Yes, 24 V with output ready
LED indicator for DC "too low"	Yes	Yes	Yes	Yes
<b>References</b>				
<b>12 VDC</b>				
Screw terminals	<b>SPD121203</b>			
<b>24 VDC</b>				
Screw terminals	<b>SPD241203</b>	<b>SPD242403</b>	<b>SPD244803</b> <b>SPD244803B</b>	<b>SPD249603</b> <b>SPD249603L</b> (without parallel function and output ready)
<b>48 VDC</b>				
Screw terminals		<b>SPD482403</b>	<b>SPD484803</b> <b>SPD484803B</b>	<b>SPD489603</b>

# Switching power supplies, redundant modules

	Bi-phase switching power supplies			Redundant modules	
Types	100 W			SPD Redundant Module	SPM Redundant Module
					
Dimensions (mm) HxWxD	90 x 54 x 114			90 x 54 x 114	91 x 35 x 56
<b>Output specifications</b>					
Voltage	12 VDC	24 VDC	48 VDC	24 VDC	Input Voltage
Current	8.4 A	4.2 A	2.1 A	20 A	10 A
Line regulation	±1%				
Load regulation	±1%				
Efficiency	86%	87%	89%		
<b>Input specifications</b>					
Voltage range	340 to 575 VAC, 480 to 820 VAC,			21 to 28VDC	5 to 48 VDC
Frequency range	47 to 63Hz				
PFC	0.55				
<b>General specifications</b>					
Ambient temperature	-25°C to +71°C			-25°C to +71°C	-25°C to +71°C
Storage	-25°C to +85°C			-25°C to +85°C	-25°C to +85°C
Derating (>60°C)	2.5% /°C				
Approvals/Marks	UL - cUL - TÜV - CE - Class I DIV2			UL - cUL - TÜV - CE	
Installation	DIN Rail			DIN Rail	DIN Rail
Connection	Screw terminals			Screw terminals	Screw terminals
<b>Main features</b>					
	Parallel function, PFC and Output ready			2 Relay outputs for remote monitoring	
LED indicator for "power on"	Yes - with relay output (SPD24 only)			Yes - with relay output (SPD24 only)	
LED indicator for DC "too low"	Yes				
<b>References</b>					
12 VDC					
Screw terminals	SPD121002				
24 VDC					
Screw terminals	SPD241002			SPD24RM20	SPM2RM2410
48 VDC					
Screw terminals	SPD481002				



# Modular switching power supplies

## Low profile DIN rail mounting

Types	SPM 1	SPM 3	SPM 4	SPM 5
				
Dimensions (mm) HxWxD	91 x 18 x 55.5	91 x 52 x 55.5	91 x 71 x 55.5	91 x 90 x 55.5
<b>Output specifications</b>				
Voltage	5VDC, 12VDC, 15VDC, 24VDC	5VDC, 12VDC, 15VDC, 24VDC	5VDC, 12VDC, 15VDC, 24VDC	5VDC, 12VDC, 15VDC, 24VDC, 24VDC (S ver.)
Current	1.5 A - 0.83 A 0.67 A - 0.42 A	3.0A - 2.1A 2.0A - 1.3A	7.0A - 4.5A 4.0A - 2.5A	12A - 6A - 5A 4.2A - 3.8A
Line regulation	±1%	±1%	±1%	±1%
Load regulation	±1%	±1%	±1%	±1%
<b>Input specifications</b>				
Voltage range	Autoselec.: 90 to 264 VAC, 120 to 370 VDC	Autoselec.: 10 to 264 VAC, 120 to 370 VDC	Autoselec.: 90 to 264 VAC, 120 to 370 VDC	Autoselec.: 90 to 264 VAC, 120 to 370 VDC
Frequency range	47 to 63Hz	47 to 63Hz	47 to 63Hz	47 to 63Hz
<b>General specifications</b>				
Ambient temperature	-25°C to +71°C	-25°C to +71°C	-25°C to +71°C	-25°C to +71°C
Storage	-25°C to +85°C	-25°C to +85°C	-25°C to +85°C	-25°C to +85°C
Derating (>60°C)	2.5 % /°C	2.5 % /°C	2.5 % /°C	2.5 % /°C
Approvals/Marks	UL - cUL - TÜV - CE - Class1 DIV2	UL - cUL - TÜV - CE - Class1 DIV2	UL - cUL - TÜV - CE - Class1 DIV2	UL - cUL - TÜV - CE - Class1 DIV2
Installation	DIN Rail	DIN Rail	DIN Rail	DIN Rail
Connection	Screw terminals	Screw terminals	Screw terminals	Screw terminals
<b>Main features</b>				
		Adjustable output voltage	Adjustable output voltage	Adjustable output voltage
LED indicator for "power on"	Yes	Yes	Yes	Yes
LED indicator for DC "too low"	Yes	Yes	Yes	Yes
<b>References</b>				
<b>5 VDC</b>	<b>SPM1-051</b>	<b>SPM3-051</b>	<b>SPM4-051</b>	<b>SPM5-051</b>
<b>12 VDC</b>	<b>SPM1-121</b>	<b>SPM3-121</b>	<b>SPM4-121</b>	<b>SPM5-121</b>
<b>15 VDC</b>	<b>SPM1-151</b>	<b>SPM3-151</b>	<b>SPM4-151</b>	<b>SPM5-151</b>
<b>24 VDC</b>	<b>SPM1-241</b>	<b>SPM3-241</b>	<b>SPM4-241</b>	<b>SPM5-241</b>
<b>24 VDC (class 2 UL)</b>				<b>SPM5-241S</b>





# Switching power supplies

## Enclosed switching power supplies

Types	20 W				35 W				60 W			
												
Dimensions (mm) HxWxD	92 x 54 x 30				78 x 51 x 28				98 x 82 x 35			
<b>Output specifications</b>												
Voltage	5 VDC	12 VDC	15 VDC	24 VDC	5 VDC	12 VDC	15 VDC	24 VDC	5 VDC	12 VDC	15 VDC	24 VDC
Current	4 A	1.7 A	1.4 A	0.9 A	6 A	3 A	2.4 A	1.5 A	9 A	5 A	4 A	2.5 A
Line regulation	± 0.5%				± 0.5%				± 0.5%			
Load regulation	± 1%				± 1%				± 1%			
Efficiency (typ)	up to 87%				up to 87%				up to 89%			
<b>Input specifications</b>												
Voltage range	88 - 264 VAC 120 - 375 VDC				88 - 264 VAC 120 - 375 VDC				88 - 264 VAC 120 - 375 VDC			
Frequency range	47- 63 Hz				47- 63 Hz				47- 63 Hz			
<b>General specifications</b>												
Ambient temperature	-40°C to +71°C				-40°C to +71°C				-40°C to +71°C			
Storage	-40°C to +85°C				-40°C to +85°C				-40°C to +85°C			
Derating (>60°C)	2.5%/°C				2.5%/°C				2.5%/°C			
Approvals/Marks	CE - TÜV - cURus				CE - TÜV - cURus				CE - TÜV - cURus			
Installation	Screw terminal				Screw terminal				Screw terminal			
<b>Main features</b>												
LED indicator for "power on"	yes				yes				yes			
Mounting	Horizontal and Vertical				Horizontal and Vertical				Horizontal and Vertical			
<b>References</b>												
5 VDC	SPP1-05201				SPP1-05351				SPP1-05601			
12 VDC	SPP1-12201				SPP1-12351				SPP1-12601			
15 VDC	SPP1-15201				SPP1-15351				SPP1-15601			
24 VDC	SPP1-24201				SPP1-24351				SPP1-24601			

# Safety modules

## Emergency stop and safety gates

Types	NES02D	NES13D	NDS12B	NA13CT
				
Dimensions (mm) HxWxD	99 x 22.5 x 114	99 x 22.5 x 114	99 x 22.5 x 114	99 x 22.5 x 114
Safety category	Up to category 4 (EN ISO 13849-1:2008)	Up to category 4 (EN ISO 13849-1:2008)	Up to category 2 (EN 13849-1: 2007)	3 (EN 954-1)
Performance level	e	e		
Function	Category 0 emergency stop module safety gates (mech. switches)	Category 0 emergency stop module safety gates (mech. switches)	Category 1 emergency stop module	Category 1 emergency stop module

### Output specifications

	2 x NO safety relay	3 x NO safety relay + 1 NC relay	1 x NO safety relay instant. 1 x NO safety relay delayed 1 x NO auxiliary relay instant.	3 x NO safety relay + 1 NC relay
Max. load AC1	6 A @ 230 VAC	6 A @ 230 VAC	5 A @ 230 VAC	6 A @ 230 VAC
Max. load DC12	6 A @ 24 VDC	6 A @ 24 VDC	5 A @ 24 VDC	
Electrical life	> 10 <sup>5</sup> operations	> 10 <sup>5</sup> operations	> 10 <sup>5</sup> operations	> 10 <sup>5</sup> operations

### Input specifications

Type	2 x NO, voltage free	2 x NO, voltage free	2 x NO, voltage free	
------	----------------------	----------------------	----------------------	--

### General specifications



Power supply	24 VAC/DC -15% +10%	24 VAC/DC -15% +10%	24 VAC/DC ±10%	18 VAC ±10% 24 VDC ±10%
Screw Terminals	Fixed [SA, SC] Detachable [DA, DC]	Fixed [SA, SC] Detachable [DA, DC]	Fixed [SA] Detachable [DA]	Fixed
Start	Automatic / Manual [SA, DA] Monitored manual [SC, DC]	Automatic / Manual [SA, DA] Monitored manual [SC, DC]	Automatic / Manual	Automatic / Manual
Approvals/Marks	CE - UL - TÜV	CE - UL - TÜV	CE	CE - UL

### References

	<b>NES02DB24SA</b>	<b>NES13DB24SA</b>	<b>NDS12BB24SA</b>	<b>NA13CT</b>
	<b>NES02DB24SC</b>	<b>NES13DB24SC</b>	<b>NDS12BB24DA</b>	
	<b>NES02DB24DA</b>	<b>NES13DB24DA</b>		
	<b>NES02DB24DC</b>	<b>NES13DB24DC</b>		







# Safety modules





	Two hand device	Safety mat & edge	
Types	ND12D	NSE02C	NST02C
			
Dimensions (mm) HxWxD	99 x 22.5 x 114	80 x 22.5 x 99.5	80 x 22.5 x 99.5
Safety category	4 (EN 954-1)	3 (EN 13849-1: 2007)	3 (EN 13849-1: 2007)
Performance level		b (EN ISO 13849-1:2008)	b (EN ISO 13849-1:2008)
Function	Two hand device	Safety mat & edge module	Safety mat module
<b>Output specifications</b>			
	2 x NO safety relay	2 x NO safety relay	2 x NO safety relay
Max. load AC1	8 A @ 230 VAC	5 A @ 230 VAC	5 A @ 230 VAC
Max. load DC12		5 A @ 24 VDC	5 A @ 24 VDC
Electrical life	> 10 <sup>5</sup> operations	> 10 <sup>5</sup> operations	> 10 <sup>5</sup> operations
<b>Input specifications</b>			
Type	2 x NO, 2 x NC, voltage free	2-wire mats or safety edges	4-wire mats (SM...)
<b>General specifications</b>			
Power supply	24 VAC/DC -15% +10% 110 VAC -15% +10% [110CG] 230 VAC -15% +10% [230CG]	24 VAC/DC ±15%	24 VAC/DC ±15%
Screw Terminals	Fixed	Fixed	Fixed
Start	Automatic	Automatic / Manual [SA, DA] Monitored manual [SC, DC]	Automatic / Manual [SA, DA] Monitored manual [SC, DC]
Approvals/Marks	CE - UL - TÜV	CE - TÜV	CE - TÜV
<b>References</b>			
	<b>ND12D</b>	<b>NSE02CB24SA</b>	<b>NST02CB24SA</b>
	<b>ND12D110CG</b>	<b>NSE02CB24SC</b>	<b>NST02CB24SC</b>
	<b>ND12D230CG</b>		

# Safety modules

## Safety gates (magnetic sensors)

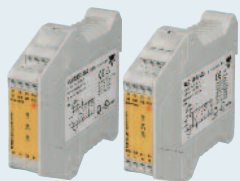
Types	NSO02	NSO13	NSC02	NSC13
				
Dimensions (mm) HxWxD	99 x 22.5 x 114	99 x 22.5 x 114	99 x 22.5 x 114	99 x 22.5 x 114
Safety category	Up to category 4 (EN ISO 13849-1:2008)	Up to category 4 (EN ISO 13849-1:2008)	Up to category 4 (EN ISO 13849-1:2008)	Up to category 4 (EN ISO 13849-1:2008)
Performance level				
Function	Safety gates module	Safety gates module	Safety gates module	Safety gates module
<b>Output specifications</b>				
	2 x NO safety relay	3 x NO safety relay + 1 NC relay	2 x NO safety relay	3 x NO safety relay + 1 NC relay
Max. load AC1	6 A @ 230 VAC	6 A @ 230 VAC	6 A @ 230 VAC	6 A @ 230 VAC
Max. load DC12	6 A @ 24 VDC	6 A @ 24 VDC	6 A @ 24 VDC	6 A @ 24 VDC
Electrical life	> 10 <sup>5</sup> operations	> 10 <sup>5</sup> operations	> 10 <sup>5</sup> operations	> 10 <sup>5</sup> operations
<b>Input specifications</b>				
Type	2 x NO, SMS or mechanical	2 x NO, SMS or mechanical	1 x NO, 1 x NC, SMS or mechanical	1 x NO, 1 x NC, SMS or mechanical
<b>General specifications</b>				
Power supply	24 VAC/DC -15% +10%	24 VAC/DC -15% +10%	24 VAC/DC -15% +10%	24 VAC/DC -15% +10%
Screw Terminals	Fixed [SA, SC] Detachable [DA, DC]	Fixed [SA, SC] Detachable [DA, DC]	Fixed [SA, SC] Detachable [DA, DC]	Fixed [SA, SC] Detachable [DA, DC]
Start	Automatic / Manual [SA, DA] Monitored manual [SC, DC]	Automatic / Manual [SA, DA] Monitored manual [SC, DC]	Automatic / Manual [SA, DA] Monitored manual [SC, DC]	Automatic / Manual [SA, DA] Monitored manual [SC, DC]
Approvals/Marks	CE - UL - TÜV	CE - UL - TÜV	CE - UL - TÜV	CE - UL - TÜV
<b>References</b>				
	<b>NSO02DB24SA</b>	<b>NSO13DB24SA</b>	<b>NSC02DB24SA</b>	<b>NSC13DB24SA</b>
	<b>NSO02DB24SC</b>	<b>NSO13DB24SC</b>	<b>NSC02DB24SC</b>	<b>NSC13DB24SC</b>
	<b>NSO02DB24DA</b>	<b>NSO13DB24DA</b>	<b>NSC02DB24DA</b>	<b>NSC13DB24DA</b>
	<b>NSO02DB24DC</b>	<b>NSO13DB24DC</b>	<b>NSC02DB24DC</b>	<b>NSC13DB24DC</b>

# Safety modules

	Safety light curtains	Lift levelling	Standstill monitor	Exstensions
Types	NLG02D NLG13D	NA12DLIFT	MF1C	NE14D
				
Dimensions (mm) HxWxD	99 x 22.5 x 114	99 x 22.5 x 114	80 x 45 x 99.5	99 x 22.5 x 114
Safety category	Up to category 4 (EN 954-1)		3 (EN 954-1)	Up to category 4
Performance level	e (EN ISO 13849-1:2008)			e (EN ISO 13849-1:2008)
Function	Light curtains safety modules	Lift levelling module (EN 81-1, 81-2, EN 12015, EN 12016)	Standstill monitor safety module 1-phase or 3-phase	Exstension safety module

## Output specifications

	2 x NO safety relay [NLG02] 3 x NO safety relay + 1 NC relay [NLG13]	2 x NO safety relay	2 x NO safety relay	4 x NO safety relay + 1NC (feedback)
Max. load AC1	6 A @ 230 VAC	6 A @ 230 VAC	8 A @ 230 VAC	8 A @ 230 VAC
Max. load DC12	6 A @ 24 VDC			
Electrical life	> 10 <sup>5</sup> operations	> 10 <sup>5</sup> operations	> 10 <sup>5</sup> operations	> 10 <sup>5</sup> operations

## Input specifications

Type	2 x NO min 10 mA / 17 V max 60 mA / 38 V [NLG02] max 30 mA / 38 V	2 x NO	Up to 500 VAC	2 x NO, voltage free
------	---	--------	---------------	----------------------

## General specifications

Power supply	24 VDC - 15% +10%	24 VAC/DC ±15%	24 VAC/DC ±15%	24 VAC/DC -15% +10% 110 VAC -15% +10% [110CG] 230 VAC -15% +10% [230CG]
Screw Terminals	Fixed [SA, SC] Detachable [DA, DC]	Fixed	Fixed	Fixed
Start	Automatic / Manual [SA, DA] Monitored manual [SC, DC]			
Approvals/Marks	CE - UL - TÜV	CE - TÜV	CE - UL - TÜV	CE - UL - TÜV

## References

NLG02D724SA	NA2DLIFT	MF1C	NE14D
NLG02D724SC			NE14D110CG
NLG02D724DA			NE14D230CG
NLG02D724DC			
NLG13D724SA			
NLG13D724SC			
NLG13D724DA			
NLG13D724DC			



# Fieldbus

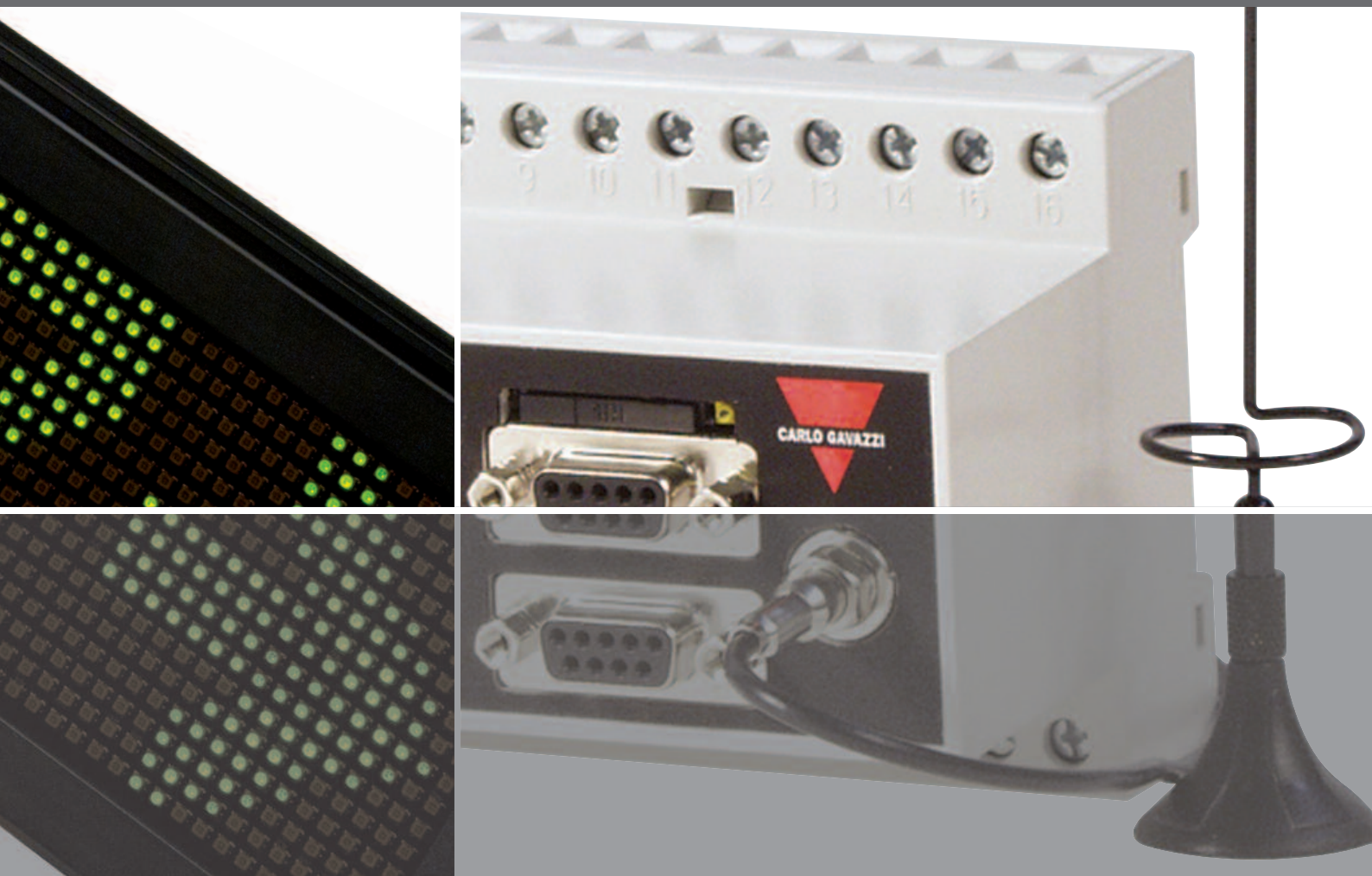

General purpose	198
DuplineSafe	212
Parking guidance system	214
Irrigation	217
Elevator	218

# Dupline® Fieldbus: general purpose

## Channel generators/interfaces

Types	G3490	G3496	G3800
			

Dimensions (mm)	77 x 72 x 70	77 x 72 x 70	77 x 144 x 70
Functions	Standard channel generator.	Plug & Play RS232/RS485 Interface with built-in protocols for specific PLC brands and Modbus.	Controller and Modbus Interface with built-in GSM Modem (option) or external Radio Modem Logger (option).
Housing type	DIN-Rail, H4	DIN-Rail, H4	DIN-Rail, H8

### Electrical specifications

Number of channels	Selectable	Selectable	Selectable
Features/Signal types		Possibility for 3-wire operation with DC-power on the 3'rd wire.	4 x Contact/PNP input +4 x PNP 10-30 VDC output 2 x RS232+1 x RS485. Possibility for alarms, monitoring and control via SMS messages.
Power Supply	024 = 24 VAC 115 = 115 VAC 230 = 230 VAC 824 = 15-30 VDC	700 = 20-30 VDC	800 = 10-30 VDC 230 = 115-230 VAC





### General specifications

Degree of protection	IP 20	IP 20	IP 20
Operating temperature	-20°C to +50°C	0°C to +50°C	0°C to +50°C
Storage temperature	-50°C to +85°C	-50°C to +85°C	-20°C to +85°C
Remarks		Built-in protocol for specific PLC brands for easy interfacing.	Up to 32 controllers can be networked together via RS485 or Ethernet via converter module.

### References

Channel Generator	<b>G3490 0000</b>	
Optolink		<b>G3496 0000</b>
LG		<b>G3496 0001</b>
GE-Fanuc		<b>G3496 0002</b>
Mitsubishi		<b>G3496 0003</b>
Omron		<b>G3496 0004</b>
Modbus		<b>G3496 0005</b>
Allen-Bradley		<b>G3496 0006</b>
Schneider		<b>G3496 0007</b>
Koyo		<b>G3496 0008</b>
Matsushita		<b>G3496 0009</b>
Siemens		<b>G3496 0010</b>
Toshiba		<b>G3496 0011</b>
IDEC		<b>G3496 0012</b>
-GSM Modem, -RS485		<b>G3496 0015</b>
+GSM Modem, -RS485		<b>G3496 1015</b>
-GSM Modem, +RS485		<b>G3496 0016</b>
+GSM Modem, +RS485		<b>G3496 1016</b>
-GSM Modem, +RS485,+Logging		<b>G3496 0036</b>
+GSM Modem, +RS485,+Logging		<b>G3496 1036</b>

# Dupline® Fieldbus: general purpose

	Channel generators/interfaces		Digital input modules	
Types	G3891	GTI50	G3410 5501	G3420
				
Dimensions (mm)	77 x 144 x 70	55 x 70 x 15 mm	77 x 72 x 70	77 x 72 x 70
Functions	Gateways to Fieldbus systems (Profibus-DP, DeviceNet etc.).	Dupline® Modbus RTU Interface module for Text Displays and Touch screens.	Dupline® powered transmitter with 8 monostable volt-free contacts.	Input module for external supply with optoisolated inputs.
Housing type	DIN-Rail, H8	Closed plastic housing with 25p male sub-D	DIN-Rail, H4	DIN-Rail, H4
<b>Electrical specifications</b>				
Number of channels	Selectable		8	8
Features/Signal types		Supports Modbus RTU function code 3 and code 16.	Volt-free input contacts.	Contact/NPN Voltage (6-265 VAC/DC).
Power Supply	230 = 115/230 VAC	Powered by RS485 port.	Powered by Dupline®.	024 = 24 VAC 115 = 115 VAC 230 = 230 VAC 800 = 10-30 VDC
<b>General specifications</b>				
Degree of protection	IP 20	IP 20	IP 20	IP 20
Operating temperature	0°C to +50°C	-20°C to +60°C	-20°C to +50°C	-20°C to +50°C
Storage temperature	-20°C to +85°C	-50°C to +85°C	-50°C to +85°C	-50°C to +85°C
Remarks			Low power consumption.	
<b>References</b>				
	<b>GTI50</b>			
Profibus-DP with C. G.	<b>G3891 0020</b>			
Profibus-DP analogue output multiplex	<b>G3891 0021</b>			
DeviceNet	<b>G3891 0050</b>			
Lonworks	<b>G3891 0051</b>			
Modbus / TCP	<b>G3891 0052</b>			
Profibus-DP passive	<b>G3891 0120</b>			
8 channel	<b>G3410 5501</b>			
Contact/NPN	<b>G3420 5501</b>			
Voltage	<b>G3420 5502</b>			

# Dupline® Fieldbus: general purpose

## Digital input modules

Types	G4420 7401	G5010	G6391 0240	G8810 2201
				

Dimensions (mm)	36 x 85 x 58	49 x 22.5 x 56	34.2 x 37.5 x 36.8	28 x 14 x 10
Functions	Input module for counting of pulses from energy meters, item detectors etc.	Dupline powered single input Module.	Plug-in module to EM4 or WM22 with 2 S0 input contacts for measuring water, gas etc.	Small-sized 2-channel monostable transmitter
Housing type	DIN-Rail, H2	DIN-Rail, Mini-E	Plug-in	Plug-in

### Electrical specifications

Number of channels	4	1	2	2
Features/Signal types	Contact input (DIN 43 864). Max. count frequency: 14 Hz.	Contact input.	Reads actual internal value of total energy and/or reactive energy from EM4/WM22 and transmits to Dupline®. 2 x S0 contact input.	2 contact inputs for push buttons.
Power Supply	230 = 230 VAC 724 = 15-30 VDC	Powered through the Dupline® network.	Powered through the Dupline® network and EM4/WM22.	Supplied by Dupline®

### General specifications





Degree of protection	IP 40	IP 20	IP 20	IP 65
Operating temperature	-20°C to +60°C	-20°C to +50°C	0°C to +50°C	-40°C to +70°C
Storage temperature	-20°C to +85°C	-50°C to +85°C	-20°C to +85°C	-40°C to +70°C
Remarks	Decentral counting. Counter values stored in non-volatile memory.			Address coding by GAP 1605.

### References





4 channel Counter	<b>G4420 7401</b>			
1 channel		<b>G5010 1106</b>		
2 channels		<b>G5010 2206</b>		<b>G8810 2201</b>
2 channel plug-in module			<b>G6391 0240</b>	



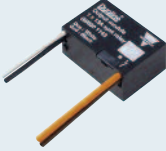

# Dupline® Fieldbus: general purpose

	Digital I/O modules		Digital output modules	
Types	G3440 4443	G3440 5543	G3430 / G3830	G34305545
				
Dimensions (mm)	77 x 72 x 70	77 x 72 x 70	77 x 72 x 70 77 x 144 x 70 (H8)	77 x 72 x 70
Functions	Combined I/O module for external supply with optoisolated inputs and relay outputs.	I/O module for digital signals.	Output modules for external supply with isolated outputs.	Central relay module with 8 x SPST relays for resistive loads.
Housing type	DIN-Rail, H4	DIN-Rail, H4	DIN-Rail, H4 DIN-Rail, H8 (G3830 5543)	DIN-Rail, H4
<b>Electrical specifications</b>				
Number of channels	4	6	1, 2, 4, 8	8
Features/Signal types	2 x 6-265 VAC/DC inputs + 2 x SPST relay outputs.	4 opto isolated inputs and 2 SPST relay outputs.	5 A SPDT relay. 5 A SPST relay. 0.7 A NPN transistor. 0.7 A PNP transistor.	8 x 16 A/250 VAC relays Inrush current: <130 A.
Power Supply	024 = 24 VAC 115 = 115 VAC 230 = 230 VAC 824 = 15-30 VDC	230 = 230 VAC	024 = 24 VAC 115 = 115 VAC 230 = 230 VAC 800 = 10-30 VDC 824 = 15-30 VDC	024 = 24 VAC 115 = 115 VAC 230 = 230 VAC
<b>General specifications</b>				
Degree of protection	IP 20	IP 20	IP 20	IP 20
Operating temperature	-20°C to +50°C	-20°C to +50°C	-20°C to +50°C	-5°C to +50°C
Storage temperature	-50°C to +85°C	-50°C to +85°C	-50°C to +85°C	-50°C to +85°C
Remarks				Total module load maximum 32 A.
<b>References</b>				
2 input + 2 output SPST	<b>G3440 4443</b>			
4 input + 2 output SPST		<b>G3440 5543</b>		
1 x 5 A SPDT			<b>G3430 1149</b>	
2 x 5 A SPDT			<b>G3430 2249</b>	
4 x 5 A SPST			<b>G3430 4443</b>	
8 x 5 A SPST			<b>G3830 5543</b>	
8 x 0.7 A NPN			<b>G3430 5511</b>	
8 x 0.7 A PNP			<b>G3430 5521</b>	
8 x 16 A SPST (Max. 32 A)				<b>G3430 5545</b>

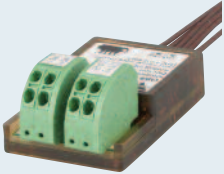
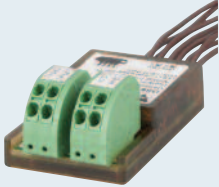

# Dupline® Fieldbus: general purpose

	Digital output modules		Analogue input modules	
Types	G8830 1143	G3429 6470	G3210 1161	G3210 1111
				
Dimensions (mm)	26 x 39 x 17	77 x 72 x 70	77 x 36 x 70	77 x 36 x 70
Functions	Decentral relay module with 1 x SPST relay for control of lights.	Universal analogue input module for external supply.	Analogue input module powered from Dupline® and input signal.	Dupline®-powered Analogue input module for Pt100 temperature sensor.
Housing type	Compact regular, with solid cables. For decentral installation.	DIN-Rail, H4	DIN-Rail, H2	DIN-Rail, H2
<b>Electrical specifications</b>				
Number of channels	1	Selectable	1	1
Features/Signal types	1 x 13 A/250 VAC relay Inrush current: <130 A.	4 x isolated analogue input. Input type individually configurable (0-20 mA, 4-20 mA, 0-10 VDC).	1 x 4-20 mA input.	1 x Pt100 3-wire input Ranges: (-50°C to +40°C) (+30°C to +120°C) (-10°C to +100°C)
Power Supply	Powered through the Dupline® network.	024 = 24 VAC 115 = 115 VAC 230 = 230 VAC 800 = 10-30 VDC	Powered through the Dupline® network and 4-20 mA input signal.	Powered through the Dupline® network.
<b>General specifications</b>				
Degree of protection	IP 20	IP 20	IP 20	IP 20
Operating temperature	0°C to +50°C	0°C to +50°C	0°C to +50°C	0°C to +50°C
Storage temperature	-50°C to +85°C	-20°C to +85°C	-50°C to +85°C	-50°C to +85°C
Remarks	Recommended minimum load 100 mA / 12 V.	Protocol freely selectable (Analink, Multiplexed BCD or 8-bit).	Uses Analink 8-bit protocol.	Uses Analink 8-bit protocol. Built-in cable compensation.
<b>References</b>				
Universal analogue output	<b>G3429 6470</b>			
Dupline powered analogue input	<b>G3210 1161</b>			
-50°C to +40°C	<b>G3210 1111</b>			
+30°C to +120°C	<b>G3210 1112</b>			
-10°C to +100°C	<b>G3210 1113</b>			
1 x 13 A SPST	<b>G8830 1143</b>			



# Dupline® Fieldbus: general purpose

	Analogue output modules		Decentral analogue input modules	
Types	G3439 6470	G8810 6265	G8810 6311	G8810 6312
				
Dimensions (mm)	77 x 72 x 70	50 X 30 X 18	50 X 30 X 18	50 X 30 X 18
Functions	Universal analogue output module for external supply.	Decentral analogue module with 3 x 0-10 VDC inputs designed for HVAC systems.	Decentral analogue module with 2 x 0-10 VDC, 1 x thermistor and 1 x variable resistor inputs designed for HVAC systems.	Decentral analogue module with 1 x thermistor and 1 x variable resistor inputs designed for HVAC systems.
Housing type	DIN-Rail, H4	Compact housing for de-central installation	Compact housing for de-central installation	Compact housing for de-central installation
<b>Electrical specifications</b>				
Number of channels	Selectable	3	4	2
Features/Signal types	4 x analogue outputs. Output type configurable for 0-20 mA, 4-20 mA or 0-10 VDC.	3 x 0-10 VDC input	2 x 0-10 VDC input 1 x thermistor 10k3 input 1 x variable resistor 1 - 11 K $\Omega$ input	1 x thermistor 10k3 input 1 x variable resistor 1 - 11 K $\Omega$ input
Power Supply	024 = 24 VAC 115 = 115 VAC 230 = 230 VAC 800 = 10-30 VDC	Powered from external 15 - 30 VDC	Powered from external 15 - 30 VDC	Dupline® powered
<b>General specifications</b>				
Degree of protection	IP 20	IP 20	IP 20	IP 20
Operating temperature	0°C to +50°C	0°C to +50°C	0°C to +50°C	0°C to +50°C
Storage temperature	-20°C to +85°C	-20°C to +85°C	-20°C to +85°C	-20°C to +85°C
Remarks	Protocol freely selectable (Analink, Multiplexed BCD or 8-bit).	Analink protocol 8 bit resolution	Analink protocol 8 bit resolution	Analink protocol 8 bit resolution
<b>References</b>				
Universal analogue output	<b>G3439 6470</b>			
Decentral 3 x input		<b>G8810 6265</b>		
Decentral 4 x input			<b>G8810 6311</b>	
Decentral 2 x input Bus powered				<b>G8810 6312</b>





# Dupline® Fieldbus: general purpose

	Digital sensors		Temp. Sensor
Types	G6110 1145	G8910 1101	G8911 1010
			
Dimensions (mm)	M18 x 55	Ø11 x 68	67 x 35 x 15
Functions	Dupline® powered inductive proximity switch.	Dupline® powered magnet proximity switch.	Temperature sensor for outdoor use. With built-in PT1000 transducer
Housing type	M18	Cylindrical	Flat pack sensor housing
<b>Electrical specifications</b>			
Number of channels	1	1	1
Features/Signal types	Detects proximity of metal objects.	Detects proximity of magnet.	1 x Analink Range: -30°C to +60°C.
Power Supply	Powered through the Dupline® network.	Powered through the Dupline® network.	Powered through the Dupline® network.
<b>General specifications</b>			
Degree of protection	IP 67	IP 67	IP 67
Operating temperature	-25°C to +70°C	-20°C to +50°C	-25°C to +70°C
Storage temperature	-30°C to +80°C	-20°C to +70°C	-55°C to +85°C
Remarks	Available with cable or M12 connector. Flush mounting.	Available in Ø 11 plastic housing or with M14 metal thread.	8-bit resolution.
<b>References</b>			
Cable	<b>G6110 1145</b>		
M12 plug	<b>G6110 1145-1</b>		<b>G8911 1010</b>
Ø11		<b>G8910 1101</b>	
M14		<b>G8910 1101-G</b>	

# Dupline® Fieldbus: general purpose





Types	Repeater		Optolink interface	
Housing	D3892 0000	G3491 0000	G3491 0090	
				
Dimensions (mm)	77 x 144 x 70	77 x 72 x 70	77 x 72 x 70	
Functions	Dupline® signal Repeater for extension of transmission distance.	Dupline® to fibre optic interface.	RS232 to fibre opto-link interface.	
Housing type	DIN-Rail, H8	DIN-Rail, H4	DIN-Rail, H4	
<b>Electrical specifications</b>				
Number of channels	Adjusts automatically.	Adjusts automatically.	Adjusts automatically.	
Features/Signal types	All Dupline® signal types. Regenerates the Dupline® signal carrier through channel-generator output.	Reads/controls up to 63 Dupline® systems which are networked through optolinks (G3491 0000)	Used as interface between computer or PLC with RS232 and a fibre optic Lan-ring	
Power Supply	024 = 24 VAC 115 = 115 VAC 230 = 230 VAC	024 = 24 VAC 115 = 115 VAC 230 = 230 VAC	024 = 24 VAC 115 = 115 VAC 230 = 230 VAC	
<b>General specifications</b>				
Degree of protection	IP 20	IP 20	IP 20	
Operating temperature	0°C to +50°C	0°C to +50°C	0°C to +50°C	
Storage temperature	-50°C to +85°C	-20°C to +85°C	-20°C to +85°C	
Remarks		Operates with G3491 0090.	Operates with G3491 0000.	
<b>References</b>				
Repeater (Booster)	<b>D3892 0000</b>			
Dupline® fibre interface		<b>G3491 0000</b>		
RS232 to optolink interface			<b>G3491 0090</b>	

## Dupline® Fieldbus: general purpose

	Converters		Display modules	Power supply
Types	G3491 0040	G3492 / G3493	G5460 6606	G3485 0000
				
Dimensions (mm)	77 x 72 x 70	77 x 72 x 70	96 x 96 x 78	77 x 72 x 70
Functions	Private line Modem for long distance transmission of Dupline® signals.	Optical repeater for converting Dupline® from electrical to optical transmission media.	LED status indicator for 16 Dupline® channels.	3-wire power supply, used when multiple Dupline® modules are supplied through a DC-bus.
Housing type	DIN-Rail, H4	DIN-Rail, H4	Panel mounting	DIN-Rail, H4
<b>Electrical specifications</b>				
Number of channels	Adjusts automatically	Adjusts automatically	16	Selectable
Features/Signal types	Digital, 8-bit analogue, non-multiplexed 3 1/2 digit BCD analogue.	All Dupline® signal types.	Each of the 16 LED's indicates the status of the digital channels assigned to it.	Supply current ≤ 4 A (up to 25°C) or ≥ 3 A (up to 50°C).
Power Supply	024 = 24 VAC 115 = 115 VAC 230 = 230 VAC	230 = 115/230 VAC	024 = 24 VAC 115 = 115 VAC 230 = 230 VAC	15-30 VDC
<b>General specifications</b>				
Degree of protection	IP 20	IP 20	IP 40	IP 20
Operating temperature	0°C to +50°C	0°C to +50°C	0°C to +50°C	-20°C to +50°C
Storage temperature	-20°C to +85°C	-20°C to +85°C	-20°C to +60°C	-50°C to +85°C
Remarks	Operates pair-wise.	Operates pair-wise. Runs on 50/125, 62.5/125 or 100/140 micro m with STN connectors.		Multiple units can be connected in parallel to increase length and size of a Dupline® system.
<b>References</b>				
Long distance modem	<b>G3491 0040</b>			
Optical/electrical converter	<b>G3492 0000</b>			
Electrical/optical converter	<b>G3493 0000</b>			
LED indicator for Dupline	<b>G5460 6606</b>			
3-wire power supply	<b>G3485 0000 700</b>			

# Dupline® Fieldbus: general purpose

## Software

Types	DUPDATAACC	DUP-SERV-ADD	DUP-SERV-SW	DUP-PGS-SWxx
				
Functions	Software package with DDE-driver and ActiveXdriver for G3800. Controller and interface unit.	A data logging, visualization and alarm handling software package to be installed in a windows based PC.	A data logging, visualization and alarm handling software package to be installed in a windows based PC.	A data logging, visualization and alarm handling software package to be installed in a windows based PC.

## Electrical specifications



Features/Signal types	All Dupline® signal types. Copy and paste of dynamic Dupline links into EXCEL spreadsheets.	Works only with G3800 xx36. Log and control energy consumption, analogue values and digital events and alarms.	Works only with G3800 xx36. Log and control energy consumption, analogue values and digital events and alarms.	Client/server program that is developed to the GP34960005 Carpark Master Module together with Moxa RS485/ethernet connectors.
-----------------------	---	--	--	---

## References

DDE-Server	<b>DUPDATAACC</b>			
Dupline-Online One License			<b>DUP-SERV-SW</b>	
ADD-License to Dupline-Online		<b>DUP-SERV-ADD</b>		
Dupline-Online two license			<b>DUP-SERV-SW2</b>	
Dupline Carpark 250 parking spaces				<b>DUP-PGS-SW250</b>
Dupline Carpark 500 parking spaces				<b>DUP-PGS-SW500</b>
Dupline Carpark 1000 parking spaces				<b>DUP-PGS-SW1000</b>
Dupline Carpark 2000 parking spaces				<b>DUP-PGS-SW2000</b>
Dupline Carpark 3000 parking spaces				<b>DUP-PGS-SW3000</b>
Dupline Carpark 4000 parking spaces				<b>DUP-PGS-SW4000</b>
Dupline Carpark 5000 parking spaces				<b>DUP-PGS-SW5000</b>
Dupline Carpark 6000 parking spaces				<b>DUP-PGS-SW6000</b>
Dupline Carpark 7000 parking spaces				<b>DUP-PGS-SW7000</b>
Dupline Carpark 8000 parking spaces				<b>DUP-PGS-SW8000</b>
Dupline Carpark 9000 parking spaces				<b>DUP-PGS-SW9000</b>
Dupline Carpark 10000 parking spaces				<b>DUP-PGS-SW10000</b>



# Dupline® Fieldbus: general purpose

## Accessories



Types	GAP1605	GTD50	GTU8
			
Dimensions (mm)	120 x 65 x 22	77 x 116 x 41	145 x 90 x 28
Functions	Dupline® coding device for assigning addresses to Dupline® I/O modules and sensors.	LCD Text Display with 2 rows x 20 characters.	Dupline® test unit for monitoring and control of Dupline® channels.
Housing type	Handheld.	Panel mounting.	Handheld.
<b>Electrical specifications</b>			
Number of channels	NA	Selectable.	Adjusts automatically.
Features/Signal types		Digital and Analink. User defined text messages linked to Dupline® channels. Read-out of Analink values. Dupline® control via front keys.	Digital, multiplexed BCD, 8-bit analogue signals and split I/O. Also prepared to calibrate sensors in Carpark system.
Power Supply	9 V battery	18-32 VDC	Powered through the Dupline® network.
<b>General specifications</b>			
Degree of protection	IP 40	IP 65 (front)	IP 40
Operating temperature	0°C to +50°C	0°C to +50°C	0°C to +50°C
Storage temperature	-20°C to +60°C	-20°C to +60°C	-20°C to +85°C
Remarks			Options for latching digital signals and for reading multiplexed BCD values.
<b>References</b>			
Programmer	<b>GAP1605</b>		
Display		<b>GTD50</b>	
Monitoring and control unit			<b>GTU8</b>



# Dupline® Fieldbus: general purpose



Accessories			
Types	G3282 2002 230	ADAPT 1605	ANT1
			
Dimensions (mm)	77 x 36 x 70	25 x 50 x 100	
Functions	Dupline® bus separator	Codings adaptor between GAP1605 and Dupline® modules without standard connection plug.	GSM antenna 900 MHz.
Housing type	H2 Housing	Handheld box	
Electrical specifications			
Number of channels	2		
Features/Signal types	Disconnect the secondary side of the Dupline® bus when a short-circuit is detected.	4 clip-on terminals for Dupline® modules. Includes a M12 plug for modules like G8911 1010.	
Power Supply	230 V		Powered by G3800 XXXX.
General specifications			
Degree of protection	IP 20	IP 20	IP 67
Operating temperature	0°C to +50°C	0°C to +50°C	-25°C to +60°C
Storage temperature	-20°C to +85°C	-20°C to +60°C	-20°C to +60°C
References			
Adaptor		<b>ADAPT 1605</b>	
Antenna			<b>ANT1</b>
Bus separator	<b>G3282 2002 230</b>		

# Dupline® Fieldbus: general purpose



Accessories			
Types	ANT2	D3212 4000	DT01
			
Dimensions (mm)	15 x 35 x 120	36 x 70 x 77	17.5 x 70 x 77
Functions	Active antenna used for radio controlled clock.	Synchronizer module for analogue modules.	Cable termination unit standard Dupline®.
Housing type	Glued plastic casing	H2 housing	H1 housing
<b>Electrical specifications</b>			
Features/Signal types	Input signal is 77.5 kHz.	Max. 112 analogue signals with up to 12 bit resolution.	Removes distortion caused by reflection.
Power Supply	Powered by G3800 XXXX.	Powered by Dupline®.	No power needed.
<b>General specifications</b>			
Degree of protection	IP 40	IP 40	IP 20
Operating temperature	0°C to +50°C	-20°C to +50°	-20°C to +50°C
Storage temperature	-20°C to +60°C	-50°C to +85°C	-50°C to +85°C
Remarks		Transmits always on A1-A4	
<b>References</b>			
Termination unit			<b>DT01</b>
Antenna	<b>ANT2</b>		
Synchronizer		<b>D3212 4000</b>	

# Dupline® Fieldbus: general purpose



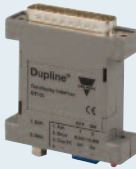

## Accessories

Types	DT02	ETHCONV 2	ETHCONV 3
			
Dimensions (mm)	17.5 x 70 x 77	22 x 75.2 x 80	22 x 90 x 100.4
Functions	Cable termination unit Hi-line.	Ethernet to RS232 converter.	Ethernet to RS232 converter.
Housing type	H1 housing	Metal housing	Metal housing
<b>Electrical specifications</b>			
Number of channels		1	2
Features/Signal types	Removes distortion caused by reflection.	1 port RJ45 10/100 Mbit TCP/IP based ethernet	2 port RJ45 10/100 Mbit TCP/IP based ethernet
Power Supply	No power needed.	12-48 VDC/130 mA	12-30 VDC/305 mA.
<b>General specifications</b>			
Degree of protection	IP 20	IP 20	IP 20
Operating temperature	-20°C to +50°C	0°C to +55°C	0°C to +55°C
Storage temperature	-50°C to +85°C	-40°C to +75°C	-40°C to +75°C
Remarks		Automatic dedicated installation tool available.	Automatic dedicated installation tool available.
<b>References</b>			
Termination unit	<b>DT02</b>		
1 Channel		<b>ETHCONV2</b>	
2 Channels			<b>ETHCONV3</b>





# Dupline® Fieldbus: DuplineSafe

	Optical fibre Converter	Output module	Gateway / interface	
Types	GS3492/GS3493	GS3830 0143	GS3891 0125	GSTI 50
				
Dimensions (mm)	77 x 72 x 70	144 x 77 x 70	144 x 77 x 70	55 x 70 x 15
Functions	Optical repeater for converting DuplineSafe from electrical to optical transmission media.	DuplineSafe relay output module. Monitors up to 63 DuplineSafe inputs.	Profibus-DP Gateway passive with Safety mapping.	Dupline® Modbus interface module with Safety mapping.
Housing type	DIN-Rail, H4	DIN-rail mounting H8	DIN-rail mounting H8.	Compact plastic housing
<b>Electrical specifications</b>				
Number of channels	Adjusts automatically	2		
Features/Signal types	All Dupline® signal types.	2 x NO Relays Force Guided contact.	Reads/controls up to 128 inputs/outputs through Profibus-DP, Communication speed up to 12 MBaud.	
Power Supply	230 = 115/230 VAC	230 VAC ± 15%	115 = 115 VAC 230 = 230 VAC	Powered by the RS485 com port.
<b>General specifications</b>				
Degree of protection	IP 20	IP 20	IP 20	IP 20
Pollution degree	0°C to +50°C	3 (IEC 60664)		
Operating temperature	-20°C to +85°C	-25°C to +50°C	0°C to +50°C	-20°C to +60°C
Storage temperature		-30°C to +70°C	-20°C to +85°C	-30°C to +85°C
Humidity (non condensing)		20 to 80%	20 to 80%	
Remarks	Operates pair-wise. Runs on 50/125, 62.5/125 or 100/140 micro m with STN connectors.	Approved according to IEC/EN 61508 and EN 954 Cat 4 by TÜV.	Certified by PNO.	Supports Modbus RTU function code 3 and code 16.
<b>References</b>				
Optical/electrical converter	<b>GS3492 0000</b>			
Electrical/optical converter	<b>GS3493 0000</b>			
Output relay		<b>GS3830 0143</b>		
Gateway / interface			<b>GS3891 0125</b>	<b>GSTI 50</b>





# Dupline® Fieldbus: DuplineSafe

	Input module	Repeater	Configuration tool	
<b>Types</b>	<b>GS7510 2101</b>	<b>GS3892 0000</b>	<b>GS7380 0080</b>	<b>GS7380 0081</b>
				
Dimensions (mm)	57.5 x 36.0 x 16.4	77 x 144 x 70	28 x 90 x 145	25 x 50 x 100
Functions	Bus-powered safety input module.	DuplineSafe signal repeater for extension of transmission distance.	Configuration and test unit for DuplineSafe.	USB Configuration unit for DuplineSafe.
Housing type		DIN-Rail H8	Handheld	Handheld
<b>Electrical specifications</b>				
Number of channels	2	Adjusts automatically		
Features/Signal types	1 x NC contact.	Regenerates the Dupline® signal carrier through channel generator output.		Windows based programming tool for safety output relay module and safety input modules.
Power Supply	Powered through the Dupline® network	024 = 024 VAC 115 = 115 VAC 230 = 230 VAC	9 V battery 6LR61	Supplied by the USB port
<b>General specifications</b>				
Degree of protection	IP 67	IP 40	IP 40	IP 40
Pollution Degree	3 (IEC 60664)			3 (IEC 60664)
Operating temperature	-40°C to +50°C	0°C to +50°C	-10°C to +45°C	0°C to +50°C
Storage temperature	-40°C to +70°C	-50°C to +85°C	-20°C to +70°C	-20°C to +60°C
Humidity (non condensing)	20 to 80%			
Remarks	Approved according to IEC/EN 61508 and EN 954 Cat 4 by TÜV.		Adapt 7380 is included.	
<b>References</b>				
		<b>GS3892 0000</b>	<b>GS7380 0080</b>	<b>GS7380 0081</b>
Cable connection	<b>GS7510 2101</b>			
Cable connection cULus approved	<b>GS7510 2192</b>			
Plug connector	<b>GS7510 2101-1</b>			
Plug connector cULus approved	<b>GS7510 2192-1</b>			



# Dupline® Fieldbus: parking guidance system

	Sensors	Carpark monitor	Passive indicators	Bus control indicators
<b>Types</b>	<b>GP6220../GP6240..</b>	<b>GP3482 9091</b>	<b>GP6289..</b>	<b>GP6265..</b>
				
Dimensions (mm)	Ø118 x 76	77 x 72 x 70	Ø118 x 76	Ø118 x 76
Functions	Ultrasonic sensors for detection of cars with or without LED indication.	Configurable device for monitoring of free parking bays in an carpark.	Passive indicator for sensor.	3 coloured bus controlled indicator.
Housing type	Direct mounting on ceiling.	Mounting on DIN rail.	Direct mounting on ceiling.	Direct mounting on ceiling.
<b>Electrical specifications</b>				
Number of channels	1 - 3	-	-	1 - 2
Features/Signal types	1 x signal for occupancy. 1 x signal for common calibration.	Programmable device with builtin RS485 for displays. 120 sensors can be connected to the Monitor module.	No programming. Only wire connected.	Colours can be controlled via the Dupline® bus.
Power Supply	3-wire system with Dupline® and sensor supply.	Dupline® 3-wire system with power for the L1 and L2 bus.		3-wire system with Dupline® and LED supply.
<b>General specifications</b>				
Degree of protection	IP 34	IP 20	IP 34	IP 34
Operating temperature	-40°C to +70°C	-40°C to +50°C	-40°C to +70°C	-40°C to +70°C
Storage temperature	-40°C to +85°C	-50°C to +85°C	-50°C to +85°C	-50°C to +85°C
<b>References</b>				
Red/Green LED	<b>GP6220 2201</b>		<b>GP6289 0101</b>	
Red/Blue LED	<b>GP6220 2202</b>		<b>GP6289 0102</b>	
Without LED	<b>GP6240 2224</b>			
Red/Green/Orange LED	<b>GP6220 3301</b>			<b>GP6265 2301</b>
Red/Green/Blue LED	<b>GP6220 3302</b>			<b>GP6265 2302</b>
Red/Blue/Orange LED	<b>GP6220 3303</b>			<b>GP6265 2303</b>
Red/Green LED US-version	<b>GP6220 2201-US</b>		<b>GP6289 0101-US</b>	
Red/Blue LED US-version	<b>GP6220 2202-US</b>		<b>GP6289 0102-US</b>	
Without LED US-version	<b>GP6240 2224-US</b>			
Red/Green/Orange LED US-version	<b>GP6220 3301-US</b>			<b>GP6265 2301-US</b>
Red/Green/Blue LED US-version	<b>GP6220 3302-US</b>			<b>GP6265 2302-US</b>
Red/Blue/Orange LED US-version	<b>GP6220 3303-US</b>			<b>GP6265 2303-US</b>
Dupline® Carpark monitor		<b>GP3482 9091 724</b>		

# Dupline® Fieldbus: parking guidance system



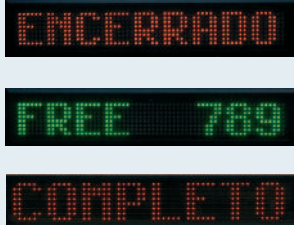

	Carpark interface		Displays	
Types	GP3496 0005	GP67630106	GP67630107-08	GP67630109-11
				
Dimensions (mm)	77 x 72 x 70	145 x 145 x 60	145 x 240 x 60	145 x 335 x 60
Functions	Interface for Modbus-RTU with the function of a slave.	Able to show green arrow, red cross or single digit	Able to show green arrow, red cross or single digit, together with disabled sign	3 character display with high flexibility to show digits, arrow, cross and disabled sign
Housing type	Mounting on DIN rail.	Aluminium box with plexiglass front	Aluminium box with plexiglass front	Aluminium box with plexiglass front
<b>Electrical specifications</b>				
Power Supply	20-30 VDC 3-wire system	18-24 VDC / 15-25 W	18-24 VDC / 30-50 W	18-24 VDC / 40-60 W
<b>Features</b>				
	RS232/RS422/RS485 port for making an interface to the control system. Multidropping of up to 16 devices on RS485.	Guides the driver by showing moving green arrow or red cross for a lane or area in the carpark	Guides the disabled driver by showing moving green arrow or red cross for a lane or area in the carpark	Guides the driver or disabled driver by showing moving green arrow or red cross as well as number of free spaces for a lane or area in the carpark
<b>General specifications</b>				
Degree of protection	IP 20	IP 55	IP 55	IP 55
Pollution degree	-	3 (IEC 60664)	3 (IEC 60664)	3 (IEC 60664)
Operating temperature	-40°C to +50°C	-15°C to +50°C	-15°C to +50°C	-15°C to +50°C
Storage temperature	-40°C to +85°C	-	-	-
Humidity	-	0 - 90% non condensing	0 - 90% non condensing	0 - 90% non condensing
<b>References</b>				
Dupline® Master Module	<b>GP3496 0005</b>			
1 segment display		<b>GP67630106</b>		
2 segment display			<b>GP67630107</b> <b>GP67630108</b>	
3 segment display				<b>GP67630109</b> <b>GP67630110</b> <b>GP67630111</b>

# Dupline® Fieldbus: parking guidance system



Displays			
Types	GP67630116	GP6763 0112 - 14	GP6763 0115
			
Dimensions (mm)	145 x 430 x 60	145 x 910 x 60 (113+114) 145 x 815 x 60 (112)	210 x 1170 x 60
Functions	4 character display with high flexibility to show digits, arrow and cross.	8 character display. 113+114 has also disabled, red cross or green arrow function.	9 character display. 113+114 has also disabled, red cross or green arrow function.
Housing type	Aluminium box with plexiglass front	Aluminium box with plexiglass front.	Aluminium box with plexiglass front.
<b>Electrical specifications</b>			
Power Supply	18-24 VDC / 60-100 W	18 - 24 VDC 35-50 W power consumption.	18 - 24 VDC Typical 35 W power consumption.
<b>Features</b>			
	Guides the driver by showing moving green arrow or red cross as well as number of free spaces for a lane or area in the carpark	Show a text on max. 8 character. The text is of costumers own choice. RS 485 communication.	Show a text on max. 9 character. The text is of costumers own choice. RS 485 communication.
<b>General specifications</b>			
Degree of protection	IP 55	IP 55	IP 55
Pollution degree	3(IEC 60664)	3(IEC 60664)	3(IEC 60664)
Operating temperature	-15°C to +50°C	-15°C to +50°C	-15°C to +50°C
Humidity	0 to 90% non condensing.	0 to 90% non condensing.	0 to 90% non condensing.
<b>References</b>			
4 segment display	<b>GP6763 0116</b>		
8 segment display		<b>GP6763 0112</b>	
		<b>GP6763 0113</b>	
		<b>GP6763 0114</b>	
9 segment display			<b>GP6763 0115</b>



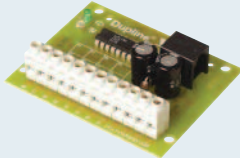

# Dupline® Fieldbus: irrigation

	Digital I/O modules		Converter	Tools
Types	GH3440 4412	GH6440 4412	GH3485 0000	GHTU8
				
Dimensions (mm)	77 x 72 x 70	80 x 77 x 50	77 x 72 x 70	145 x 90 x 28
Functions	I/O module for irrigation valve control.	I/O module for irrigation valve control.	Dupline® to Hi-Line converter.	Dupline test unit for monitoring and control of Dupline® channels. Used for Hi-line modules.
Housing type	DIN-Rail, H4	Fully molded housing for under ground installation.	DIN-Rail, H4	Handheld
<b>Electrical specifications</b>				
Number of channels	4	4	Adjusts automatically.	Adjusts automatically.
Features/Signal types	2 outputs for control of 3-wire 12 VDC latching valve, and 2 contact inputs.	2 outputs for control of 3-wire 12 VDC latching valve, and 2 contact inputs.	Converts the Dupline® signal to Hi-Line 28 VDC level for control of irrigation valves (see GH3440 4412 and GH6440 4412).	Digital, multiplexed BCD and 8-bit analogue signals.
Power Supply	Powered through Hi-Line signal (see GH34850000).	Powered through Hi-Line signal (see GH34850000).	724 = 20-30 VDC.	Powered through the Dupline® network.
<b>General specifications</b>				
Degree of protection	IP 20	IP 67	IP 20	IP 40
Operating temperature	0°C to +50°C	0°C to +50°C	0°C to +50°C	0°C to +50°C
Storage temperature	-50°C to +85°C	-50°C to +85°C	-50°C to +85°C	-20°C to +85°C
Remarks				Options for latching digital signals and for reading multiplexed BCD values.
<b>References</b>				
2 outputs and 2 inputs	<b>GH3440 4412</b>	<b>GH6440 4412</b>		
Converter			<b>GH3485 0000</b>	
Monitoring and control unit				<b>GHTU8</b>

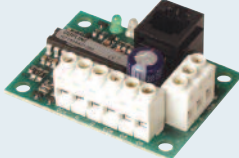
## Dupline® Fieldbus: elevator

	Input module	Output module	Input/output module
Types	G2120	G2130	G2140 4421
			
Dimensions (mm)	Open PCB 72.3 x 59	Open PCB 74 x 59	Open PCB 54 x 40
Functions	8 contact inputs for push buttons or transistors. LED indications for supply and carrier.	8 outputs for control of floor indicators and lamps. LED indications for supply and carrier.	2 push button inputs. 2 PNP-transistor outputs. LED indications for supply and carrier.
Housing type	Snap locks or DIN-rail (vertical or horizontal)	Snap locks or DIN-rail (vertical or horizontal)	Snap locks or DIN-rail (vertical or horizontal)
<b>Electrical specifications</b>			
Number of channels	8	8	8
Features/Signal types	3-wire operation with DC-power on wire 3.	3-wire operation with DC-power on wire 3.	3-wire operation with DC-power on wire 3.
Power Supply	700 = 10 - 30 VDC	700 = 10 - 30 VDC	700 = 10 - 30 VDC
<b>General specifications</b>			
Operating temperature	-20°C to +50°C	-20°C to +50°C	-20°C to +50°C
<b>References</b>			
NPN	G2120 5501 700	G2130 5511 700	
PNP	G2120 5502 700	G2130 5521 700	G2140 4421 700

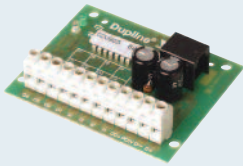
# Dupline® Fieldbus: elevator

	Input/output module	Master modules	
Types	G2140 55.0	G2196	G3496
			
Dimensions (mm)	Open PCB 74 x 59	Open PCB 86 x 54	77 x 72 x 70
Functions	4 push-button inputs 4 transistor outputs LED indications for supply and carrier.	128 signals RS 485/RS 232 interface to control system LED indications for supply, carrier and RS485Tx.	Plug & Play RS232/RS485 Interface with built-in protocols for specific PLC brands and Modbus.
Housing type	Snap locks or DIN-rail (vertical or horizontal)	Snap locks or DIN-rail (vertical or horizontal)	DIN-Rail, H4
<b>Electrical specifications</b>			
Number of channels	8	128 inputs and 128 outputs.	Selectable.
Features/Signal types	3-wire operation with DC-power on wire 3.	3-wire operation with DC-power on wire 3.	Possibility for 3-wire operation with DC-power on the 3'rd wire.
Power Supply	700 = 10 - 30 VDC	700 = 20 - 30 VDC	700 = 20 - 30 VDC
<b>General specifications</b>			
Degree of protection			IP 20
Operating temperature	-20°C to +50°C	-20°C to +60°C	0°C to +50°C
Storage temperature			-50°C to +85°C
Remarks			Built-in protocol for specific PLC brands for easy interfacing.
<b>References</b>			
NPN	<b>G2140 5510 700</b>		
PNP	<b>G2140 5520 700</b>		
Standard protocol		<b>G2196 0000 700</b>	<b>G3496 0000</b>
Lucky Goldstar K-series		<b>G2196 0001 700</b>	<b>G3496 0001</b>
GE-Fanuc 90-30 series		<b>G2196 0002 700</b>	<b>G3496 0002</b>
Mitsubishi FX & A-series		<b>G2196 0003 700</b>	<b>G3496 0003</b>
Omron		<b>G2196 0004 700</b>	<b>G3496 0004</b>
Modbus RTU Slave		<b>G2196 0005 700</b>	<b>G3496 0005</b>
Allen-Bradley			<b>G3496 0006</b>
Schneider			<b>G3496 0007</b>
Koyo			<b>G3496 0008</b>
Matsushita			<b>G3496 0009</b>
Siemens			<b>G3496 0010</b>
Toshiba			<b>G3496 0011</b>
IDEC			<b>G3496 0012</b>



**EcoEnergy**  
equipment



Solar inverters	222
Solar control solution	225
Digital energy production display	229

# Solar inverters

## Single-phase, grid tied PV inverters

Types	ISMG 1 45 PL3	ISMG 1 45	ISMG 1 50	ISMG 1 60
				

Dimensions (mm) HxWxD      580 x 422 x 182      580 x 422 x 182      580 x 422 x 182      580 x 422 x 182

Features      MPP Tracking controlled by exclusive smart MPPT technology with possibility of managing the different string independently or paralleled all or partially. Transformerless with Electronic RCMU circuit. 2 ports RS232/RS485 for remote monitoring. Anti-islanding circuit and Grid monitoring, integrated DC switch to ensure high safety level. IP 65, Outstanding operating temperature.

### DC input specifications

DC input Power	3.6 kW	4.0 kW	4.64 kW	5.38 kW
Min / Max Voltage	100 / 500 Vdc	100 / 500 Vdc	100 / 500 Vdc	100 / 500 Vdc
MPP Voltage range	100 to 450	100 to 450	100 to 450	100 to 450
Max Current per String	10 A	10 A	10 A	10 A
Number of strings	2	2	2	3
Number of Trackers	2 indep. (could work a Master Slave)	2 indep. (could work a Master Slave)	2 indep. (could work a Master Slave)	3 indep. (could work as 2+1)

### AC output specifications

Grid connection	Single phase, true sinewave	Single phase, true sinewave	Single phase, true sinewave	Single phase, true sinewave
Nominal AC Power	2.99 kW	3.3 kW	3.8 kW	4.6 kW
Maximum AC Power	2.99 kW	3.8 kW	4.4 kW	5.1 kW (DE version 5.0 kW)
Power factor	> 0.99	> 0.99	> 0.99	> 0.99
Distortion (THD)	< 3%	< 3%	< 3%	< 3%
AC Voltage	Rated 230 Vac	Rated 230 Vac	Rated 230 Vac	Rated 230 Vac
AC rated Current	13 A	14.34 A	16.52 A	20 A
Frequency	Rated 50 Hz	Rated 50 Hz	Rated 50 Hz	Rated 50 Hz

### General specifications

Operating Temperature	-10°C to +60°C (derating > +60°C, Shutdown @ +75°C)	-10°C to +60°C (derating > +60°C, Shutdown @ +75°C)	-10°C to +60°C (derating > +60°C, Shutdown @ +75°C)	-10°C to +60°C (derating > +60°C, Shutdown @ +75°C)
Humidity	0 to 95% RH	0 to 95% RH	0 to 95% RH	0 to 95% RH
Protection degree	IP 65	IP 65	IP 65	IP 65
Cooling	Forced Ventilation: electronically controlled fans	Forced Ventilation: electronically controlled fans	Forced Ventilation: electronically controlled fans	Forced Ventilation: electronically controlled fans
Max Efficiency	96.2%	96.2%	96.3%	96.3%
EU Efficiency	95.4%	95.4%	95.1%	95.4%
Noise level	< 40 dB	< 40 dB	< 40 dB	< 40 dB
Approvals	CE, VDEW, VDE0126-1-1, DK5940, RD1663 / RD661	CE, VDEW, VDE0126-1-1, DK5940, RD1663 / RD661	CE, VDEW, VDE0126-1-1, DK5940, RD1663 / RD661	CE, VDEW, VDE0126-1-1, DK5940, RD1663 / RD661

### References

Italy		<b>ISMG 1 45 IT</b>	<b>ISMG 1 50 IT</b>	<b>ISMG 1 60 IT</b>
Germany		<b>ISMG 1 45 DE</b>	<b>ISMG 1 50 DE</b>	<b>ISMG 1 60 DE</b>
Spain		<b>ISMG 1 45 ES</b>	<b>ISMG 1 50 ES</b>	<b>ISMG 1 60 ES</b>
France	<b>ISMG 1 45 FR PL3</b>	<b>ISMG 1 45 FR</b>	<b>ISMG 1 50 FR</b>	<b>ISMG 1 60 FR</b>
Greece		<b>ISMG 1 45 GR</b>	<b>ISMG 1 50 GR</b>	<b>ISMG 1 60 GR</b>
Others	<b>ISMG 1 45 EN PL3</b>	<b>ISMG 1 45 EN</b>	<b>ISMG 1 50 EN</b>	<b>ISMG 1 60 EN</b>

# Solar inverters

## HF transformer, grid tied PV inverters

Types	ISMGT 1 28	ISMGT 1 38	ISMGT 1 40	ISMGT 1 50
				

Dimensions (mm) HxWxD	768 x 454 x 175	768 x 454 x 175	768 x 454 x 210	768 x 454 x 210
-----------------------	-----------------	-----------------	-----------------	-----------------

**Features**  
 The ISMGT inverters are galvanically insulated between input and output thus suitable for all types of Modules: poly and single crystal, thin film with positive or negative grounding. The front switch interrupts both DC and AC sides. The positive or negative grounding of panels can be set by mean of internal dip switches. It is possible to connect up to 4 separate strings. The units are also equipped with Ground fault fuse in order to increase safety during operation, automatic internal fans reduce temperature when it is exceeding the set value in order to generate more energy also with high environmental temperatures.

### DC input specifications

DC input Power	3.1 kW	4.1 kW	4.3 kW	5.3 kW
Min / Max Voltage	150 / 600 Vdc	150 / 600 Vdc	150 / 600 Vdc	150 / 600 Vdc
MPP Voltage range	200 to 550	200 to 550	200 to 550	200 to 550
Max Current per String	15 A	15 A	15 A	15 A
Number of strings	3	4	4	4
Number of Trackers	1	1	1	1

### AC output specifications

Grid connection	Single phase, true sinewave	Single phase, true sinewave	Single phase, true sinewave	Single phase, true sinewave
Nominal AC Power	2.8 kW	3.8 kW	4.0 kW	5.0 kW
Maximum AC Power	2.8 kW	3.8 kW	4.0 kW	5.0 kW
Power factor	> 0.99	> 0.99	> 0.99	> 0.99
Distortion (THD)	< 3%	< 3%	< 3%	< 3%
AC Voltage	Rated 230 Vac	Rated 230 Vac	Rated 230 Vac	Rated 230 Vac
AC rated Current	12.2 A	16.6 A	17.4 A	21.8 A
Frequency	Rated 50 Hz	Rated 50 Hz	Rated 50 Hz	Rated 50 Hz

### General specifications

Operating Temperature	-25°C to + 58°C @ full power	-25°C to + 55°C @ full power	-25°C to + 58°C @ full power	-25°C to + 54°C @ full power
Humidity	0 to 95% RH	0 to 95% RH	0 to 95% RH	0 to 95% RH
Protection degree	IP 44	IP 44	IP 44	IP 44
Cooling	Air convection	Forced Ventilation: electronically controlled fans	Forced Ventilation: electronically controlled fans	Forced Ventilation: electronically controlled fans
Max Efficiency	96.4%	96.4%	96.5%	96.5%
EU Efficiency	95.4%	95.7%	95.8%	95.8%
Noise level	< 40 dB	< 40 dB	< 40 dB	< 40 dB
Approvals	CE, VDEW, VDE0126-1-1, DK5940, RD1663 / RD661, G83	CE, VDEW, VDE0126-1-1, DK5940, RD1663 / RD661, G59	CE, VDEW, VDE0126-1-1, DK5940, RD1663 / RD661, G59	CE, VDEW, VDE0126-1-1, DK5940, RD1663 / RD661, G59

### References

Italy	ISMGT 1 28D IT	ISMGT 1 38D IT	ISMGT 1 40D IT	ISMGT 1 50D IT
Germany	ISMGT 1 28D DE	ISMGT 1 38D DE	ISMGT 1 40D DE	ISMGT 1 50D DE
Spain	ISMGT 1 28D ES	ISMGT 1 38D ES	ISMGT 1 40D ES	ISMGT 1 50D ES
France	ISMGT 1 28D FR	ISMGT 1 38D FR	ISMGT 1 40D FR	ISMGT 1 50D FR
Greece	ISMGT 1 28D GR	ISMGT 1 38D GR	ISMGT 1 40D GR	ISMGT 1 50D GR
UK	ISMGT 1 28D UK	ISMGT 1 38D UK	ISMGT 1 40D UK	ISMGT 1 50D UK
Others	ISMGT 1 28D EN	ISMGT 1 38D EN	ISMGT 1 40D EN	ISMGT 1 50D EN

# Solar inverters

## Three-phase, grid tied PV inverters

### Types

#### ISMG 3 17

#### ISMG 3 22



Dimensions (mm) HxWxD

890.5 x 751 x 256

890.5 x 751 x 256

Features

2 different MPP Tracking circuits controlled by smart MPPT technology with possibility of managing the different string independently or parallel. Transformerless with Electronic RCMU circuit. Integrated Graphic display with 5 keys pad and minilogger, 2 ports RS232/RS485 for remote monitoring. Anti-islanding circuit and Grid monitoring, integrated DC switch to ensure high safety level. IP 55, wide operating temperature range.

### DC Input specifications

DC input Power	17.9 kW	23.1 kW (21 kW)*
Min / Max Voltage	300 / 850 Vdc	300 / 850 Vdc
MPP Voltage range	300 to 850 Vdc	300 to 850 Vdc
Max Current per String	21.6 A	28.9 A
Number of strings	2	2
Number of Trackers	2 indep.	2 indep.

### AC Output specifications

Grid connection	3 phase, balanced, true sinewave	3 phase, balanced, true sinewave
Nominal AC Power	17 kW	22 kW (19.99 kW)*
Maximum AC Power	17 kW	22 kW (19.99 kW)*
Power factor	> 0.99 @ rated power	> 0.99 @ rated power
Distortion (THD)	< 5%	< 5%
AC Voltage	Rated 3 x 400 Vac	Rated 3 x 400 Vac
AC rated Current	24.7 A	31.9 A (29.4 A)*
Frequency	Rated 50 Hz	Rated 50 Hz

### General specifications

Max Operating Temperature	+50°C @ full power	+45°C @ full power
Humidity	0 to 95% RH	0 to 95% RH
Protection degree	IP 65	IP 65
Cooling	Forced Ventilation: electronically controlled fans	Forced Ventilation: electronically controlled fans
Max Efficiency	97.4%	97.6%
EU Efficiency	97.0%	97.2%
Noise level	< 50 dB	< 55 dB
Approvals	CE, VDE0126-1-1, DK5940, RD1663 / RD661	CE, VDE0126-1-1, DK5940, RD1663 / RD661

### References





Italy	<b>ISMG 3 17 IT</b>	<b>ISMG 3 20 IT</b>
Germany	<b>ISMG 3 17 DE</b>	<b>ISMG 3 20 DE</b>
Spain	<b>ISMG 3 17 SP</b>	<b>ISMG 3 20 SP</b>
France	<b>ISMG 3 17 FR</b>	<b>ISMG 3 20 FR</b>
Greece	<b>ISMG 3 17 GR</b>	<b>ISMG 3 20 GR</b>
Others	<b>ISMG 3 17 EN</b>	<b>ISMG 3 20 EN</b>

\* Values for Italian version







# Solar control solution

## EOS-Array solar control solution

Types	VMU-M	VMU-S	VMU-P	VMU-O...AT
				
Dimensions (mm) HxWxD	1-DIN module	1-DIN module	1-DIN module	1-DIN module
Description	Master unit 6-DGT readout	String unit, with built-in protection fuseholder	Environment variable measurement unit	Inputs/outputs unit
Function	VMU-M performs the local bus management of VMU-S, VMU-P both measuring units and VMU-O I/O unit.	Variables measuring unit, DC current, voltage, power and energy metering. String control and efficiency measurement.	PV module temperature, air temperature, sun irradiation and wind speed metering.	VMU-O allows to add, for every single unit, available in the local bus two digital inputs and two relay outputs.
<b>Input specifications</b>				
Range code	2 Pt100 or Pt1000, 3-wire (-50.0 to +200.0°C) or one digital input and one pulse input. [T2]	Direct connections 16A/1000VDC [AV10]. Measurements: V, A, W, Wh.	2 Pt100 or Pt1000, 3-wire (PV and air temperature). 1 irradiation input (up to 120 mV). 1 wind speed input (0 to 1000 Hz max.) [2TIW].	2 digital inputs for "Protection trip detection or others" [I2].
Accuracy	±(0.5%RDG + 5DGT)	±(0.5%RDG + 2DGT)	±(0.2%RDG + 1DGT)	
<b>Output specifications</b>				
Alarm	Real and virtual alarm management of all variables coming from VMU-M, VMU-S, and VMU-P with event logging			2 digital outputs for alarm notification as string alarm or as a digital input status changing. SPST relay type. [R2]
Serial communication	Local bus: up to 15 mixed VMU-S, VMU-P and VMU-O units RS485 communication port (Modbus) [S1]	Local bus: up to 15 VMU-S units in the same bus [S]	Local bus: one VMU-P unit per bus [S]	Local bus: up to 7 VMU-O units
Others	Data logger (V, A, W, PV cell and air temperature, irradiation, wind speed) DC/AC efficiency.	Diagnostics functions: antitheft control, fuse blow detection, wrong PV panel connection. Front multicolor LED to show the status of the unit.	Front multicolour LED to show the status of the unit.	Front multicolor LED to show the status of the unit.
<b>General specifications</b>				
Power supply	12 to 28 VDC power supply [A].	Self-power supply from VMU-M unit [X].	Self-power supply from VMU-M unit [X].	Self-power supply from VMU-M unit [X].
Approvals/Marks	cULus approved.	cULus approved.	cULus approved.	cULus approved.
<b>References</b>				
For ordering key details, please refer to <a href="http://www.productselection.net">www.productselection.net</a>				

# Solar control solution

## EOS-Array Lite solar control solution

Types	VMU-ML	VMU-S0	VMU-P	VMU-O
				
Dimensions (mm) HxWxD	1-DIN module	1-DIN module	1-DIN module	1-DIN module
Description	Master unit 6-DGT readout	String unit, with built-in protection fuseholder	Environment variable measurement unit	Outputs unit
Function	VMU-ML performs the local bus management of VMU-S0, VMU-P both measuring units and VMU-O output unit.	Variables measuring unit, DC current and voltage.	PV module temperature, air temperature, sun irradiation.	VMU-O allows to add, for every single unit, available in the local bus, one relay outputs.
<b>Input specifications</b>				
Range code		Direct connections 16A/1000VDC [AV10]. Measurements: V, A.	1 Pt100 or Pt1000, 3-wire (PV and air temperature). 1 irradiation input (up to 120mV). [1TI].	
Accuracy		±(0.5%RDG + 2DGT)	±(0.2%RDG + 1DGT)	
<b>Output specifications</b>				
Alarm	Single real or virtual alarm management of all variables coming from VMU-ML, VMU-S0, and VMU-P with event logging			1 digital output for alarm notification as string alarm. SPST relay type. [R1]
Serial communication	Local bus: up to 15 mixed VMU-S0, VMU-P and VMU-O units RS485 communication port (Modbus) [S1]	Local bus: up to 15 VMU-S0 units in the same bus [S]	Local bus: one VMU-P unit per bus [S]	Local bus: up to 7 VMU-O units
Others	Front dual colour LED to show the status of the unit.	Diagnostics functions: wrong PV panel connection.	Front multicolor LED to show the status of the unit.	Front multicolor LED to show the status of the unit.
<b>General specifications</b>				
Power supply	12 to 28 VDC power supply [A].	Self-power supply from VMU-ML unit [X].	Self-power supply from VMU-ML unit [X].	Self-power supply from VMU-ML unit [X].
Approvals/Marks	cULus approved.	cULus approved.	cULus approved.	cULus approved.
<b>References</b>				
For ordering key details, please refer to <a href="http://www.productselection.net">www.productselection.net</a>				

# Solar control solution

## EOS-Array solar control solution

## Surge arresters for PV systems

### Types

### VMUAT

### DSF



Dimensions (mm) HxWxD

1-DIN module

90 x 36 x 72 [52]  
90 x 54 x 72 [53X]

Description

Optical fiber anti-theft sensor

2-pole [52] or 3-pole [53]  
surge arresters for P.V. installations.  
Removable cartridges.  
Exhausted cartridge indication contact [C].

### Input specifications

Range code

Optical fiber plastic type  
PF0221000

### Output specifications

Out 1 (Alarm)

1 x SPDT relay, N.O.

Out 1 (Pulse)

NPN or PNP

### General specifications

SPD class

Class II

Max. continuous voltage  
Uc

600 VDC [600]  
1000 VDC [1000]  
1200 VDC [1200]

I<sub>n</sub> (8/20)

20 kA [600, 1200]  
12.5 kA [1000]

I<sub>max</sub> (8/20)

40 kA [600, 1200]  
25 kA [1000]

Response time

< 25 ns

Back-up fuse

Not required up to 200 kArms

Power supply

Self power supply through VMU-X unit [X]

Approvals/Marks

CE

CE, UR (UL 1449 3<sup>rd</sup> ED.), UTE C 61-740-51

### References

For ordering key details, please refer to  
[www.productselection.net](http://www.productselection.net)

**DSF52CD600PV**

**DSF52XD1000PV**

**DSF52CD1000PV**

**DSF53XD1200PV**

**DSF53CD1200PV**

# Solar control solution

## Web-server

### Types

### Eos-Box



Dimensions (mm) WxHxD	225 x 225 x 45
Description	Eos-Box is a web server that controls and supervises the whole installation, acquiring information from: Eos-Array groups; inverters; energy meters; interface protection. The Eos-Box provides information via the internet, so the data is available wherever you are.
Type	Embedded PC
Operating system	Windows XP embedded
Operation	Fan less
Processor	AMD LX800 500MHz
Chipset	AMD LX+CS5536+ITE8888G
BIOS	Phoenix-Award 4Mbit with RPL/PXE LAN Boot ROM. SmartView and customer CMOS backup
Memory DDR	256MB SODIMM
Memory DOM	8GB
Back-up industrial CompactFlash™	8GB Type II (on request)

### Communication port and Output specifications

RS485	3 ports for Eos Array bus management 1 port for inverter and meters
Ethernet	1 for internet/LAN connection; 1 for local access
USB	3, for local access and external modem connection

### LED

Status and colour	Green for power-on. Orange for DOM memory access
-------------------	--

### Connections

RS485	3 pole detachable screw terminal block per port
Ethernet	RJ-45 connector (10/100 Base-T)
USB	High speed USB 2.0

### Power supply

Voltage Supply	100 to 240 VAC
Power Consumption	70 W

### References

**EOSBOXDXXX**

# Digital energy production display

## DPY series

Types	DPY 3	DPY 4	DPY 5
			

Dimensions (mm) HxWxD	500 x 700 x 80	420 x 500 x 70	800 x 1600 x 80
-----------------------	----------------	----------------	-----------------

Features	<p>With DPY 3 display it is possible to remotely show the production data of your own renewable energy production plant, this device can become a powerful marketing tool. The 3 fields can display actual power generation, the total Energy produced and the CO<sub>2</sub> saved. The construction can be indoor or outdoor, furthermore the background, the lettering and the logo can be customized. Can be connected to CG EM 24 or EM26.</p>	<p>With DPY 4 display it is possible to remotely show the production data of your own renewable energy production plant, The 4 rows are completely programmable. The pages are dynamic and can change after a certain programmed time. The bottom line can be scrolling. The background, the lettering and the logo can be customized. Can be connected to CG EM 24 or EM26.</p>	<p>The DPY 5 is the biggest display of the range. It has a real time clock and displays date time and temperature besides the production data: irradiation, actual power, energy, co2 saved and the days since installation.</p>
----------	---	--	--

### Display specifications

Number of lines / fields	3	4	5 / 8
Digits per line	5 + 6 + 6	programmable matrix	8 + 5 + 3 + 4 + 5 + 6 + 6 + 4
Digits dimension (mm)	50 X 70	425 x 30	50 X 70
Pixel type	High brightness LED	High brightness LED	High brightness LED
Brightness regulation	Automatic with crepuscular sensor	Automatic with crepuscular sensor	Automatic with crepuscular sensor
Autoranging	only outdoor version	yes	yes
Rolling / Scrolling	no	yes	no

### Mechanical specifications

Housing material	powder coated aluminium	powder coated aluminium	powder coated aluminium
Front screen	Lexan 8mm	Lexan 8mm	Lexan 8mm
Front layout	Vynil 4 colours	Vynil 4 colours	Vynil 4 colours
Fixing / installation	Wall mounting brackets	Wall mounting brackets	Wall mounting brackets
Protection degree Indoor	IP 40	IP 20	IP 40
Protection degree Outdoor	IP 54	No	IP 54

### General specifications

Power supply	230 Vac 50 Hz	230 Vac 50 Hz	230 Vac 50 Hz
Communication	RS232 / RS 485	RS232 / RS 485	RS 485

### References

Indoor Standard	<b>DPY 30 70 50 HX</b>	<b>DPY 40 60 42 I</b>	<b>DPY 50 80 160 HX</b>
Indoor customized	<b>DPY 30 70 50 HP</b>	<b>DPY 40 60 42 IP</b>	<b>DPY 50 80 160 HP</b>
Outdoor Standard	<b>DPY 30 74 54 EX</b>		<b>DPY 50 80 160 EX</b>
Outdoor customized	<b>DPY 30 74 54 EP</b>		<b>DPY 50 80 160 EP</b>





## OUR SALES NETWORK IN EUROPE

**AUSTRIA** - Carlo Gavazzi GmbH  
Ketzergrasse 374, A-1230 Wien  
Tel: +43 1 888 4112  
Fax: +43 1 889 10 53  
office@carlogavazzi.at

**BELGIUM** - Carlo Gavazzi NV/SA  
Schaarbeeklei 213/3, B-1800 Vilvoorde  
Tel: +32 2 257 4120  
Fax: +32 2 257 41 25  
sales@carlogavazzi.be

**DENMARK** - Carlo Gavazzi Handel A/S  
Over Hadstenvej 40, DK-8370 Hadsten  
Tel: +45 89 60 6100  
Fax: +45 86 98 15 30  
handel@gavazzi.dk

**FINLAND** - Carlo Gavazzi OY AB  
Petaksentie 2-4, FI-00661 Helsinki  
Tel: +358 9 756 2000  
Fax: +358 9 756 20010  
myynti@gavazzi.fi

**FRANCE** - Carlo Gavazzi Sarl  
Zac de Paris Nord II, 69, rue de la Belle  
Etoile, F-95956 Roissy CDG Cedex  
Tel: +33 1 49 38 98 60  
Fax: +33 1 48 63 27 43  
french.team@carlogavazzi.fr

**GERMANY** - Carlo Gavazzi GmbH  
Pfnorstr. 10-14  
D-64293 Darmstadt  
Tel: +49 6151 81000  
Fax: +49 6151 81 00 40  
info@gavazzi.de

**GREAT BRITAIN** - Carlo Gavazzi UK Ltd  
7 Springlakes Industrial Estate,  
Deadbrook Lane, Hants GU12 4UH,  
GB-Aldershot  
Tel: +44 1 252 339600  
Fax: +44 1 252 326 799  
sales@carlogavazzi.co.uk

**ITALY** - Carlo Gavazzi SpA  
Via Milano 13, I-20020 Lainate  
Tel: +39 02 931 761  
Fax: +39 02 931 763 01  
info@gavazziacbu.it

**NETHERLANDS** - Carlo Gavazzi BV  
Wijkermeerweg 23,  
NL-1948 NT Beverwijk  
Tel: +31 251 22 9345  
Fax: +31 251 22 60 55  
info@carlogavazzi.nl

**NORWAY** - Carlo Gavazzi AS  
Melkeveien 13, N-3919 Porsgrunn  
Tel: +47 35 93 0800  
Fax: +47 35 93 08 01  
post@gavazzi.no

**PORTUGAL** - Carlo Gavazzi Lda  
Rua dos Jerónimos 38-B,  
P-1400-212 Lisboa  
Tel: +351 21 361 7060  
Fax: +351 21 362 13 73  
carlogavazzi@carlogavazzi.pt

**SPAIN** - Carlo Gavazzi SA  
Avda. Iparraguirre, 80-82,  
E-48940 Leioa (Bizkaia)  
Tel: +34 94 480 4037  
Fax: +34 94 480 10 61  
gavazzi@gavazzi.es

**SWEDEN** - Carlo Gavazzi AB  
V:a Kyrkogatan 1,  
S-652 24 Karlstad  
Tel: +46 54 85 1125  
Fax: +46 54 85 11 77  
info@carlogavazzi.se

**SWITZERLAND** - Carlo Gavazzi AG  
Verkauf Schweiz/Vente Suisse  
Sumpfstrasse 32,  
CH-6312 Steinhausen  
Tel: +41 41 747 4535  
Fax: +41 41 740 45 40  
info@carlogavazzi.ch

## OUR SALES NETWORK IN NORTH AMERICA

**USA** - Carlo Gavazzi Inc.  
750 Hastings Lane,  
USA-Buffalo Grove, IL 60089,  
Tel: +1 847 465 6100  
Fax: +1 847 465 7373  
sales@carlogavazzi.com

**CANADA** - Carlo Gavazzi Inc.  
2660 Meadowvale Boulevard,  
CDN-Mississauga Ontario L5N 6M6,  
Tel: +1 905 542 0979  
Fax: +1 905 542 22 48  
gavazzi@carlogavazzi.com

**MEXICO** - Carlo Gavazzi Mexico S.A. de C.V.  
Calle La Montaña no. 28, Fracc. Los Pastores  
Naucalpan de Juárez, EDOMEX CP 53340  
Tel & Fax: +52.55.5373.7042  
mexicosales@carlogavazzi.com

## OUR SALES NETWORK IN ASIA AND PACIFIC

**SINGAPORE** - Carlo Gavazzi Automation  
Singapore Pte. Ltd.  
61 Tai Seng Avenue  
#05-06 UE Print Media Hub  
Singapore 534167  
Tel: +65 67 466 990  
Fax: +65 67 461 980

**MALAYSIA** - Carlo Gavazzi Automation  
(M) SDN. BHD.  
D12-06-G, Block D12,  
Pusat Perdagangan Dana 1,  
Jalan PJU 1A/46, 47301 Petaling Jaya,  
Selangor, Malaysia.  
Tel: +60 3 7842 7299  
Fax: +60 3 7842 7399

**CHINA** - Carlo Gavazzi Automation  
(China) Co. Ltd.  
Unit 2308, 23/F.,  
News Building, Block 1, 1002  
Middle Shennan Zhong Road,  
Shenzhen, China  
Tel: +86 755 83699500  
Fax: +86 755 83699300

**HONG KONG** - Carlo Gavazzi  
Automation Hong Kong Ltd.  
Unit 3 12/F Crown Industrial Bldg.,  
106 How Ming St., Kwun Tong,  
Kowloon, Hong Kong  
Tel: +852 23041228  
Fax: +852 23443689

## OUR COMPETENCE CENTRES AND PRODUCTION SITES

Carlo Gavazzi Industri A/S  
Hadsten - **DENMARK**

Carlo Gavazzi Ltd  
Zejtun - **MALTA**

Carlo Gavazzi Controls SpA  
Belluno - **ITALY**

Uab Carlo Gavazzi Industri Kaunas  
Kaunas - **LITHUANIA**

Carlo Gavazzi Automation  
(Kunshan) Co., Ltd.  
Kunshan - **CHINA**

## HEADQUARTERS

Carlo Gavazzi Automation SpA  
Via Milano, 13 - I-20020  
Lainate (MI) - **ITALY**  
Tel: +39 02 931 761  
info@gavazziautomation.com

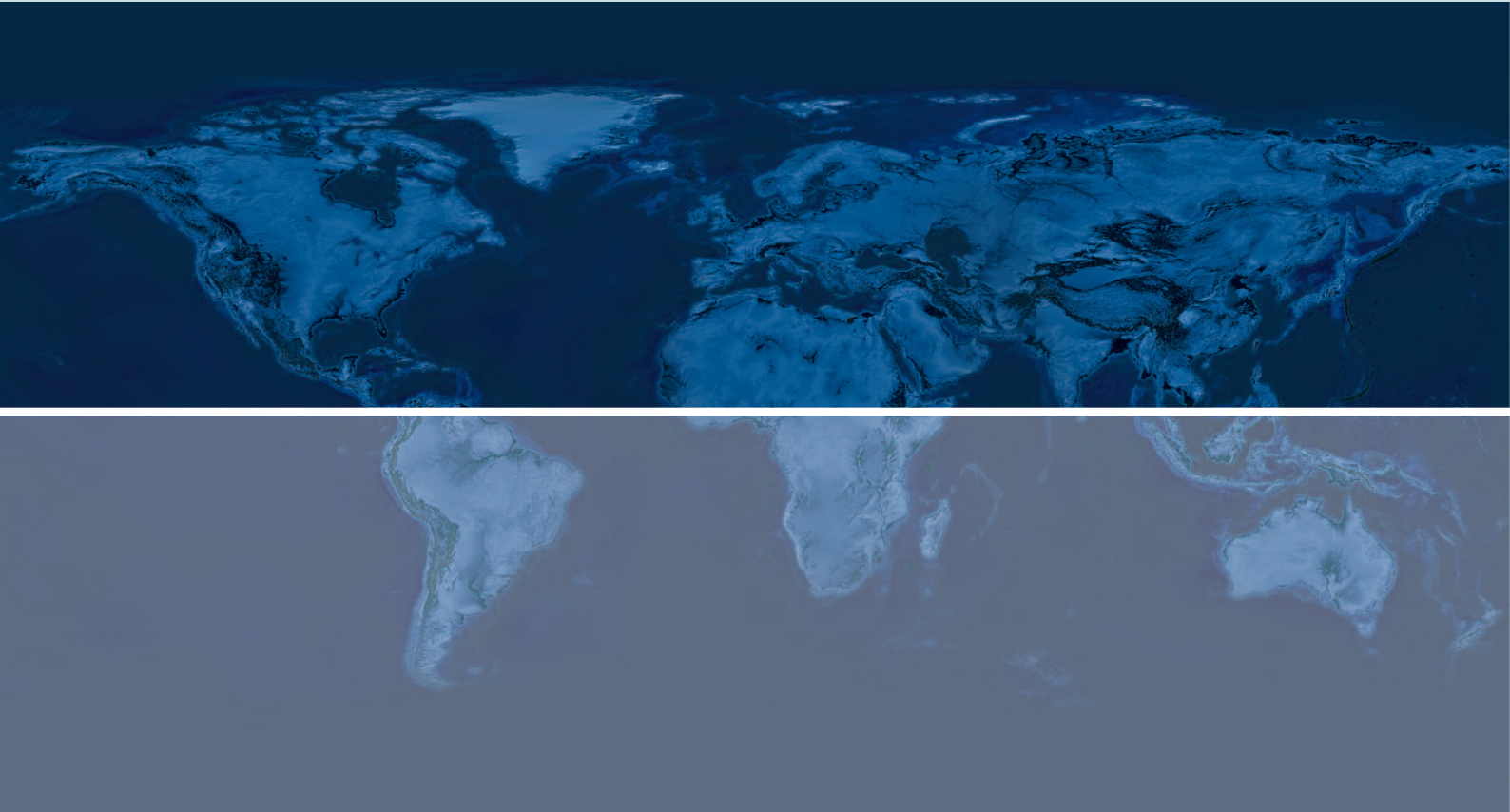

**80**  
**CARLO GAVAZZI**  
1931–2011

**CARLO GAVAZZI**  
Automation Components

*Energy to Components!*

[www.gavazziautomation.com](http://www.gavazziautomation.com)

