

SPECIFICATIONS
 Current Rating:5A AC,DC
 Voltage Rating:250V AC,DC
 Temperature Range:-25°C~+85°C
 Contact Resistance:10 Milliohms Max.
 Insulation Resistance:1000 Megohms Min.
 Withstanding Voltage:1500V AC/Minute
 Material:Nylon 66,UL 94V-2
 RoHS Compliant

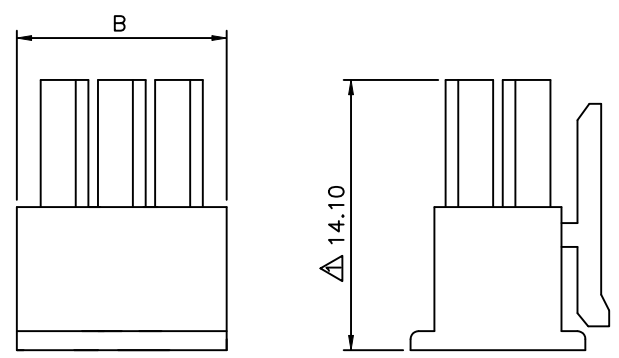

2x3P~2x12P

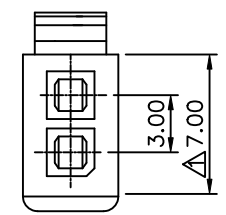
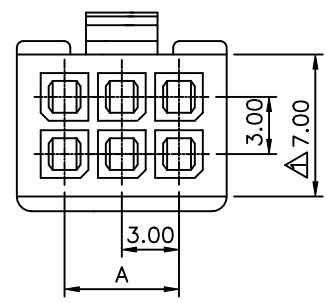
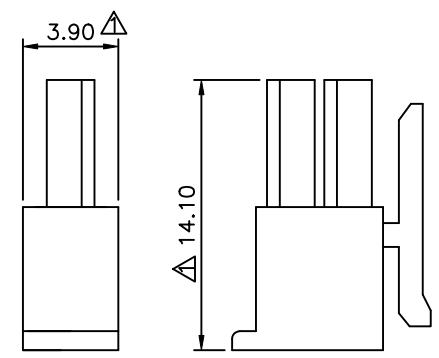

2x1P

Poles	Dim. A	Dim. B
2		3.85
4	3.00	6.85
6	6.00	9.85
8	9.00	12.85
10	12.00	15.85
12	15.00	18.85
14	18.00	21.85
16	21.00	24.85
18	24.00	27.85
20	27.00	30.85
22	30.00	33.85
24	33.00	36.85

AUK A MEMBER OF AUK GROUP
太聯事業股份有限公司
AUK CONTRACTORS CO., LTD.

CATEGORY		APPROVED BY		UNLESS OTHERWISE SPECIFIED TOLERANCES ARE .X ±0.50 .XX ±0.25 .XXX ±0.10 ANG. ±2°				
PART No. MIF2XXXSH-H		MEI						
DRAWING No. MIF2XXXSH-H		CHECKED BY BECKY						
SCALE NONE		DRAWING BY JLT						
SCALE	NONE	REV.	A1	UNIT mm				
					A1 Modify Dim HZF 09/02/2008 A0 NEW RELEASE BECKY 01/25/2005			
					NO.REV. REVISIONS		CHK	DATE

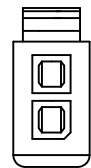

2*1

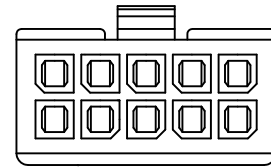

2*5

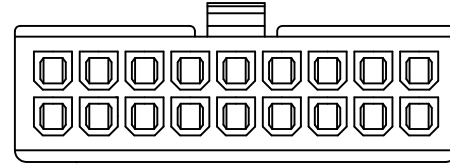

2*9

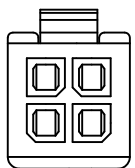

2*2

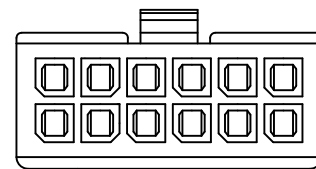

2*6

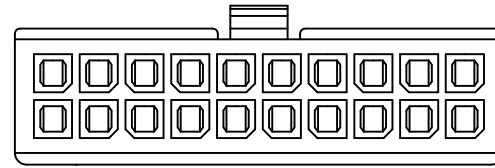

2*10

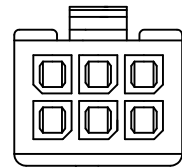

2*3

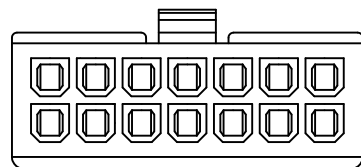

2*7

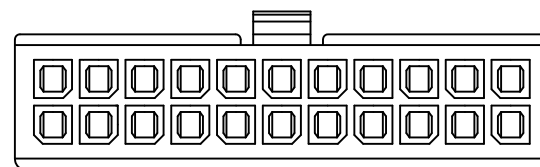

2*11

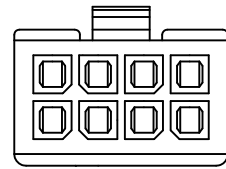

2*4

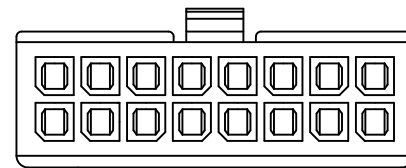

2*8

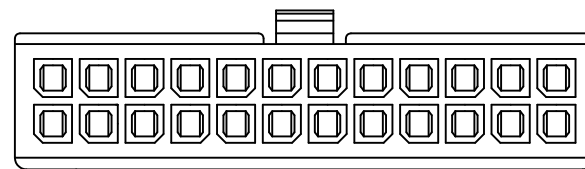

2*12

AUK A MEMBER OF AUK GROUP
太聯事業股份有限公司
AUK CONTRACTORS CO., LTD.

CATEGORY		APPROVED BY		UNLESS OTHERWISE SPECIFIED TOLERANCES ARE .X ±0.50 .XX ±0.25 .XXX ±0.10 ANG. ±2°				
PART No. MIF2XXXSH-H		MEI						
DRAWING No. MIF2XXXSH-H		CHECKED BY BECKY						
SCALE NONE		DRAWING BY JLT						
SCALE	NONE	REV.	A1	UNIT mm				
		REV. A1		NO. REV.		REVISIONS		
				A1 Modify Dim		HZF	09/02/2008	
				A0 NEW RELEASE		BECKY	01/25/2005	
				CHK		DATE		