

REVISION RECORD				
REV	ECN	DESCRIPTION	DRFT	DATE

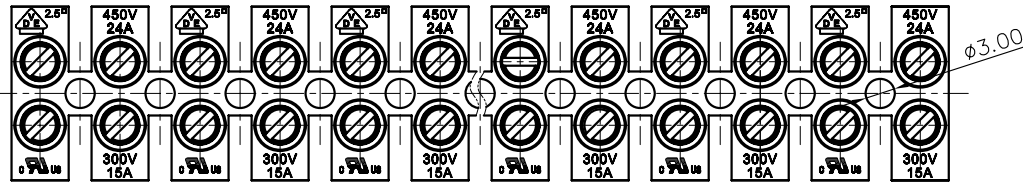

NOTES1:

- UL Standard
 1.Rated Voltage/Current : 300V / 15A
 2.Torque Value : M2.5 , 3.54Lb.in
 3.Wire Range : 20~14AWG

IEC Standard

- 1.Rated Voltage/Current : 450V / 24A
 2.Torque Value : M2.5 , 0.4N·m
 3.Wire Range : 0.5~2.5mm²

NOTES2:

- 1.Dimension shall be interpreted per ASME Y14.5-2009
 2.Pitch : 8.20mm, Poles : N=02~12P
 3.Stripping length : 8mm
 4.Withstanding Voltage : AC2500V/1Min.
 5.Operating temperature: -40°C~+105°C
 6.Undimensioned Tolerances:

Pitch range in mm	Nominal dimension range in mm						0.1/10		
	Over 6 TO 6	Over 10 TO 10	Over 30 TO 30	Over 60 TO 60	Over 100 TO 100	Over 150 TO 150			
	±0.15	±0.20	±0.30	±0.30	±0.50	±0.70	±1.00	±1.30	±2*

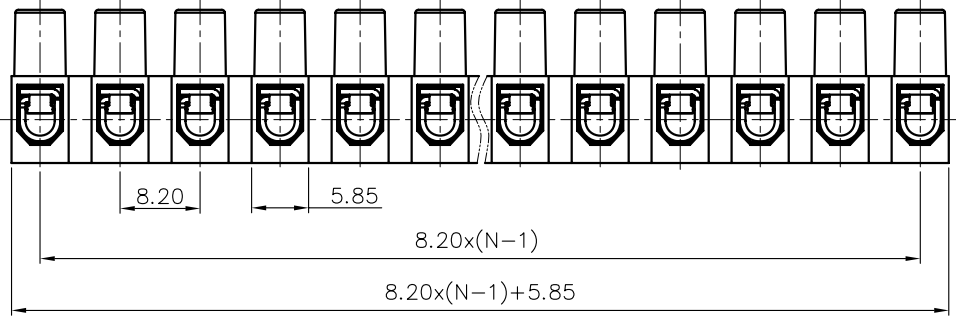
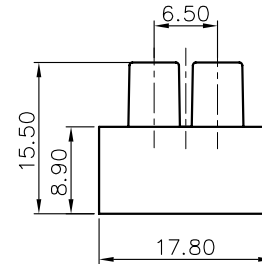

7.RoHS Compliance

DG8HSPW-1.2 - XXP - 1Y - 100A (H)
 (Series No.) (Poles) (Single Pitch) (Color): 1.(Grey)
 2.(Blue)
 3.(Black)
 4.(Green)
 5.(Orange)
 6.(Red)
 7.(Transparent)
 8.(Yellow)
 9.(White)

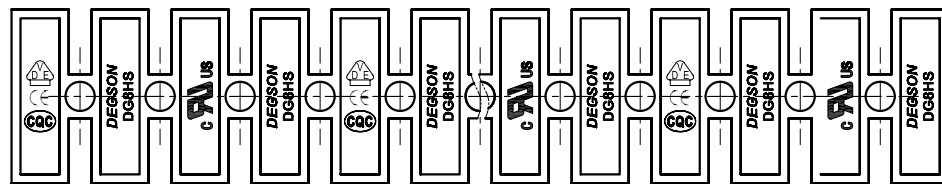

DETACHED LISTS	PART NO.:	NINGBO DEGSON ELECTRICAL CO., LTD			
	APPD:	NAME: DG8HSPW-1.2-XXP-1Y-100A(H)			
	CHKD:	TITLE: CUSTOMER DRAWING		REV	DO
	DRFT:	DRAWING NO.:		SHEET	1/1
	THIRD ANGLE PROJECTION		MM (INCH)	DO NOT SCALE DRAWING	SCALE

REVISION RECORD				
REV	ECN	DESCRIPTION	DRFT	DATE

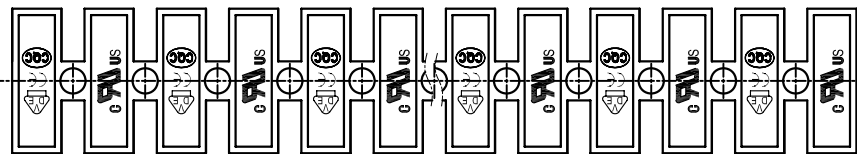
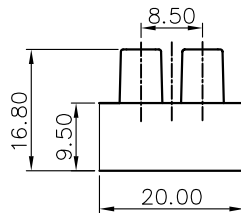
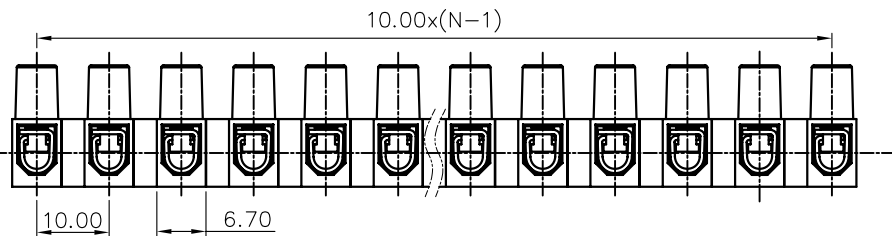
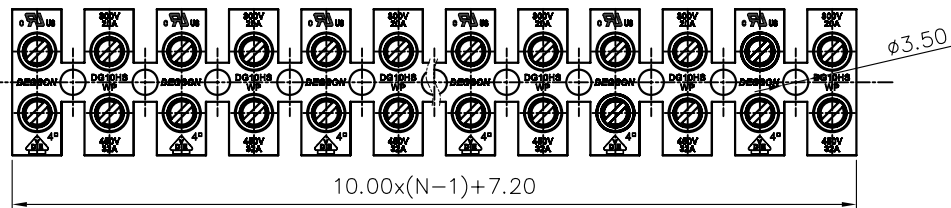

NOTES1:

- UL Standard
 1. Rated Voltage/Current : 300V / 20A
 2. Torque Value : M2.6 , 3.54Lb.in
 3. Wire Range : 18~12AWG

IEC Standard

1. Rated Voltage/Current : 450V / 32A
 2. Torque Value : M2.6 , 0.4N·m
 3. Wire Range : 0.5~4.0mm²

NOTES2:

1. Dimension shall be interpreted per ASME Y14.5-2009
 2. Pitch : 10.00mm, Poles : N=02~12P
 3. Stripping length : 8mm
 4. Withstanding Voltage : AC2500V/1Min.
 5. Operating temperature : -40°C~+105°C
 6. Undimensioned Tolerances:

Pitch range in mm		Nominal dimension range in mm						0.1/10
Over TO	Over TO	Over TO	Over TO	Over TO	Over TO	Over TO		
6	10	24	30	60	100	150		
±0.15	±0.20	±0.30	±0.30	±0.50	±0.70	±1.00	±1.30	
							±2°	

7. RoHS Compliance

DG10HWP-1.2 - XXP - 1Y - 100A (H)
 (Series No.) (Poles) (Single Pitch) (Color): 1.(Grey)
 2.(Blue)
 3.(Black)
 4.(Green)
 5.(Orange)
 6.(Red)
 7.(Transparent)
 8.(Yellow)
 9.(White)

DETACHED LISTS	PART NO.:	/			
	APPD:	/			
	CHKD:	/			
	DRFT:	/			
	THIRD ANGLE PROJECTION		DRAWING NO.:		/
		MM (INCH)		DO NOT SCALE DRAWING	
		TITLE: CUSTOMER DRAWING		REV	DO
		SHEET		1/1	
		SCALE		1:1	

REVISION RECORD

REV	ECN	DESCRIPTION	DRFT	DATE
-----	-----	-------------	------	------

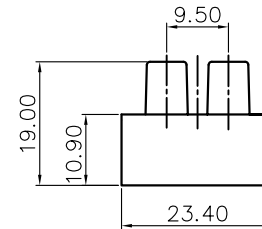
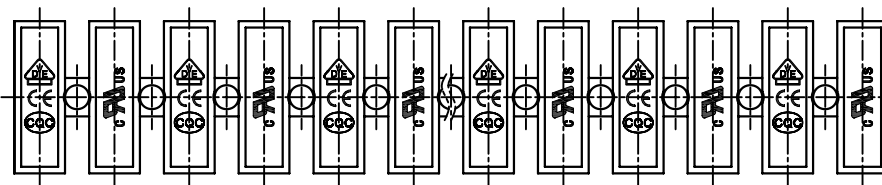
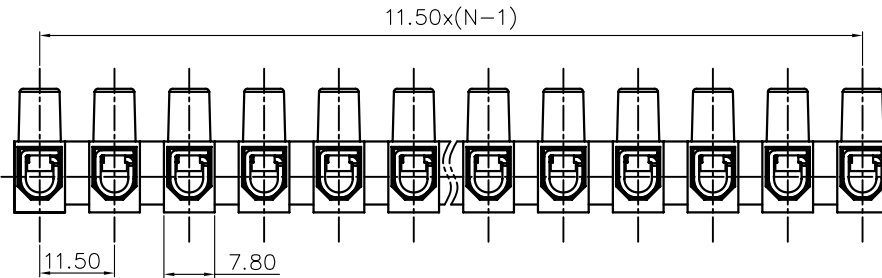
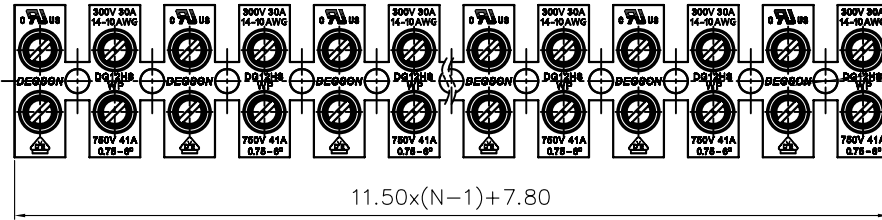

NOTES1:

- UL Standard
 1.Rated Voltage/Current : 300V / 30A
 2.Torque Value : M3.5 , 7.02Lb.in
 3.Wire Range : 14~10AWG

IEC Standard

- 1.Rated Voltage/Current : 750V / 41A
 2.Torque Value : M3.5 , 0.8N·m
 3.Wire Range : 0.75~6.0mm²

NOTES2:

- 1.Dimension shall be interpreted per ASME Y14.5-2009
 2.Pitch : 11.50mm, Poles : N=02~12P
 3.Stripping length : 8mm
 4.Withstanding Voltage : AC3000V/1Min.
 5.Operating temperature: -40°C~+105°C
 6.Undimensioned Tolerances:

Pitch range in mm		Nominal dimension range in mm				0.1/10										
To	Over	To	Over	To	Over											
6	10	6	10	30	60	100	150	±0.15	±0.20	±0.30	±0.30	±0.50	±0.70	±1.00	±1.30	±2*

7.RoHS Compliance

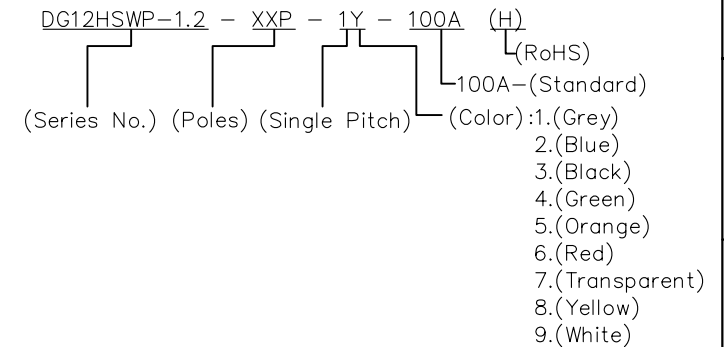

DETACHED LISTS	PART NO.:	/				宁波高松电子有限公司 NINGBO DEGSON ELECTRICAL CO., LTD			
	APPD:	/				NAME: DG12HSPW-1.2-XXP-1Y-100A(H)			
	CHKD:	/				TITLE: CUSTOMER DRAWING			
	DRFT:	/				REV		D0	
THIRD ANGLE PROJECTION		DRAWING NO.:		/		SHEET		1/1	
		MM (INCH)		DO NOT SCALE DRAWING		SCALE		1:1	

REVISION RECORD				
REV	ECN	DESCRIPTION	DRFT	DATE

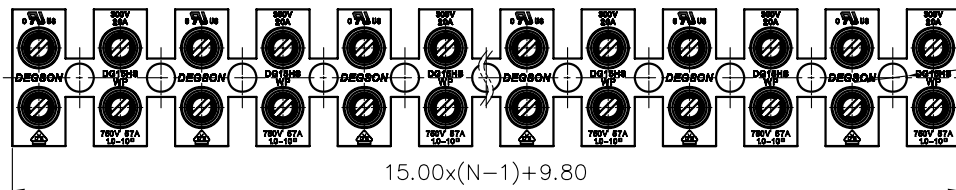

φ5.20

$15.00 \times (N-1) + 9.80$

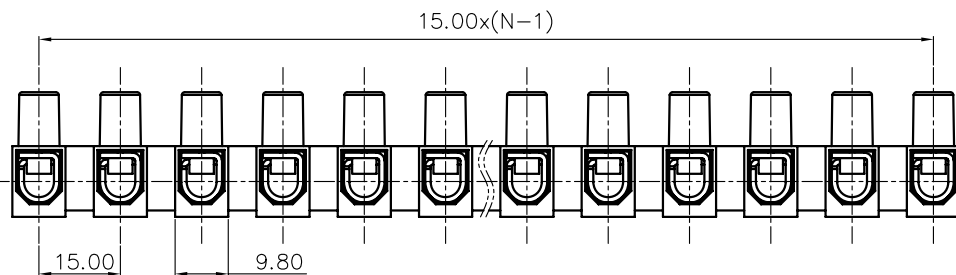

$15.00 \times (N-1)$

15.00

9.80

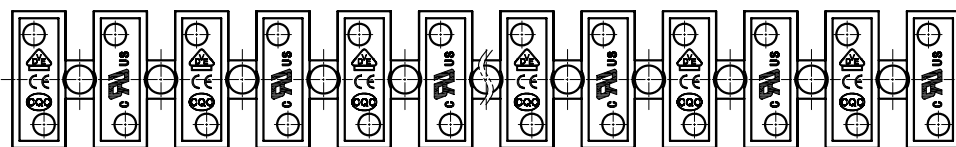

NOTES1:

- UL Standard
 1. Rated Voltage/Current : 300V / 20A
 2. Torque Value : M4 , 10.53Lb.in
 3. Wire Range : 12AWG

IEC Standard

1. Rated Voltage/Current : 750V / 57A
 2. Torque Value : M4.0 , 1.2N·m
 3. Wire Range : 1.5~10mm²

NOTES2:

1. Dimension shall be interpreted per ASME Y14.5-2009
 2. Pitch : 15.00mm, Poles : N=02~12P
 3. Stripping length : 8mm
 4. Withstanding Voltage : AC3000V/1Min.
 5. Operating temperature: -40°C~+105°C
 6. Undimensioned Tolerances:

Pitch range in mm	Nominal dimension range in mm				0.1/10
	Over 6 TO 10	Over 10 TO 24	Over 30 TO 60	Over 60 TO 150	
±0.15	±0.20	±0.30	±0.30	±0.50	±1.30
					±2°

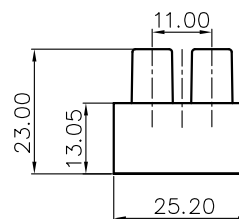

7. RoHS Compliance

DG15HWP-1.2 - XXP - 1Y - 100A (H)
 (Series No.) (Poles) (Single Pitch) (Color): 1.(Grey)
 2.(Blue)
 3.(Black)
 4.(Green)
 5.(Orange)
 6.(Red)
 7.(Transparent)
 8.(Yellow)
 9.(White)

DETACHED LISTS	PART NO.:	/			宁波高松电子有限公司 NINGBO DEGSON ELECTRICAL CO., LTD	
	APPD:	/	NAME:		DG15HWP-1.2-XXP-1Y-100A(H)	
	CHKD:	/	TITLE:		CUSTOMER DRAWING	REV
	DRFT:	/	DRAWING NO.:		/	SHEET
	THIRD ANGLE PROJECTION		DO NOT SCALE DRAWING	SCALE	1:1	D0