

P/N LEGEND

A12514	WR-S-XP	N	L	X	T1	T	00	R
①	② ③ ④	⑤	⑥	⑦	⑧	⑨	⑩	⑪

① Series No.
 ② Connector type: WR=Right angle
 ③ Mounting type: S=SMT TYPE
 ④ No. of circuits
 ⑤ N=Halogen Free
 ⑥ Material: L=LCP ;
 ⑦ Color: N=Natural ; B=Black
 ⑧ Plating code for contacts:
 T1=Matte Tin-plated;
 ⑨ Plating code for solder tabs:
 T=Matte Tin-plated;
 ⑩ Option code: 00=Standard
 ⑪ Packing code: R=Tape & Reel

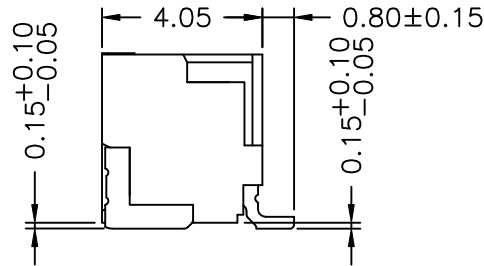
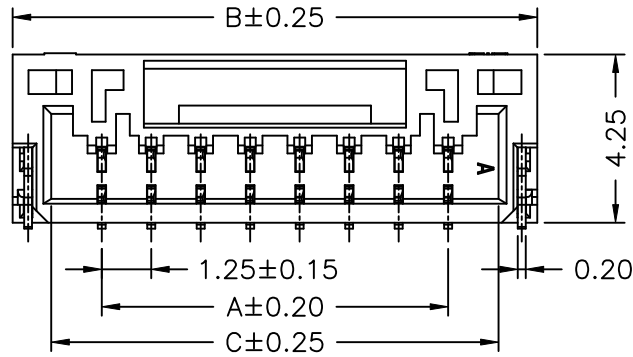

SPECIFICATIONS

Current Rating: 1A AC,DC
 Voltage Rating: 50V AC,DC
 Temperature Range: -25°C ~ +85°C
 Contact Resistance: 30mΩ Max.
 Insulation Resistance: 100MΩ Min.
 Withstanding Voltage: 500V AC/minute
 Pin Material: Phosphor Bronze
 Solder Tabs: Brass

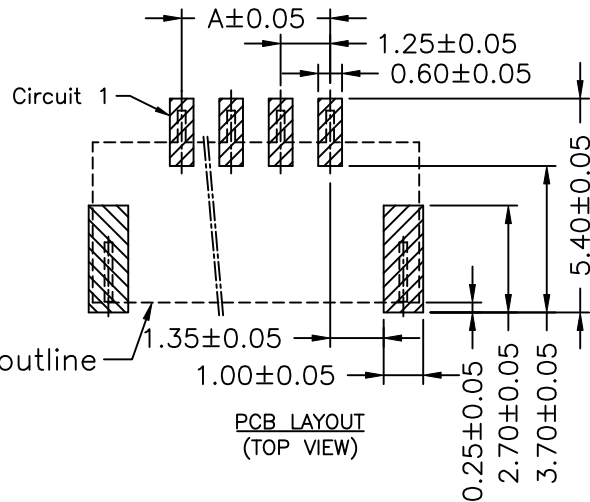

Circuit No.	Dimensions			Circuit No.	Dimensions		
	A	B	C		A	B	C
02P	1.25	5.75	3.80	09P	10.00	14.50	12.55
03P	2.50	7.00	5.05	10P	11.25	15.75	13.80
04P	3.75	8.25	6.30	11P	12.50	17.00	15.05
05P	5.00	9.50	7.55	12P	13.75	18.25	16.30
06P	6.25	10.75	8.80	13P	15.00	19.50	17.55
07P	7.50	12.00	10.05	14P	16.25	20.75	18.80
08P	8.75	13.25	11.30	15P	17.50	22.00	20.05

				燦達電子工業股份有限公司 JOINT TECH ELECTRONIC IND. CO., LTD.			
		UNIT	SCALE	SHEET		TITLE:	
		mm	1 : 1	1 of 3		1.25mm PITCH 90° WAFER-SMT TYPE	
A5	EN202206071082	2022.06.08	徐貴湖	DRAWN BY		APPROVED BY	
A4	EN202204201026	2022.04.14	徐貴湖	徐富永		徐富永	
A3	EN20220331988	2022.02.18	徐貴湖	2020.06.17		2020.06.17	
A2	EN20210312583	2021.04.22	鄭小嬌	GENERAL TOLERANCE			
A1	EN20210113550	2021.03.23	鄭小嬌	X. X±0.25		ANGLE±	
A0	NEW RELEASE	2020.06.17	鄭小嬌	X. XX±0.15		DRAW NO. :	
REV.	DESCRIPTION	DATE	NAME	X. XXX±0.05		A12514WR-S-XPXXXXXXXXX	
						REV.	A5



塑膠各PIN外觀差異

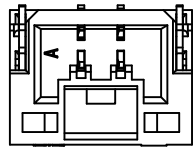

02P

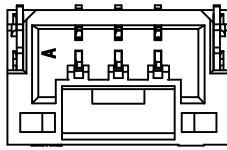

03P

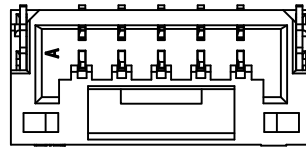

04~05P

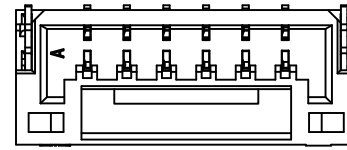

06P

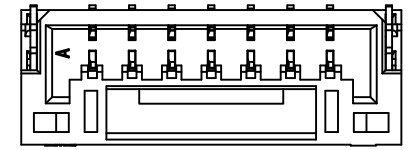

07P

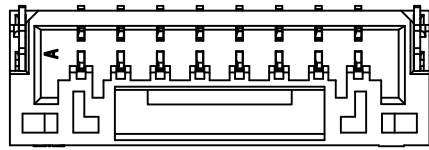

08P

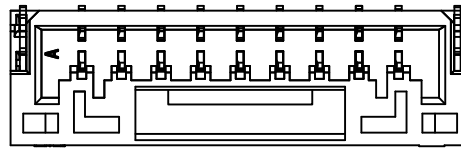

09P

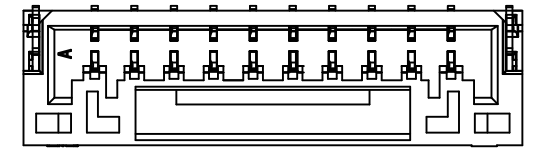

10P

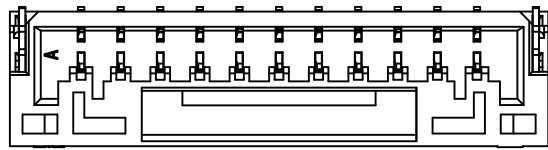

11P

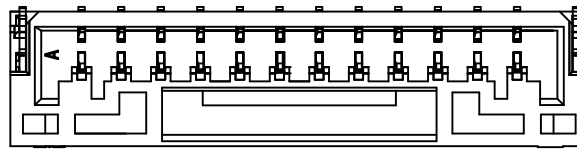

12P

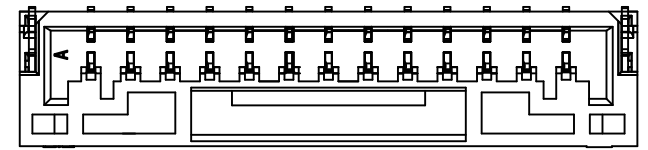

13P

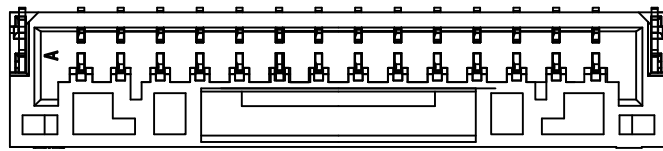

14P

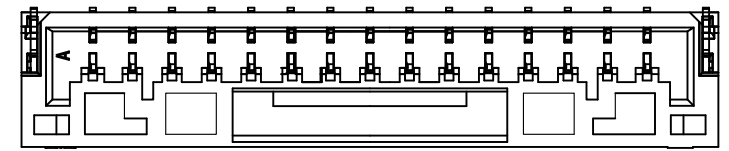

15P



燦達電子工業股份有限公司
JOINT TECH ELECTRONIC IND. CO., LTD.

UNIT	SCALE	SHEET
mm	1 : 1	2 of 3

TITLE:

DRAWN BY	APPROVED BY
徐富永	徐富永
2020.06.17	2020.06.17

GENERAL TOLERANCE	
X. X±0.25	ANGLE±
X. XX±0.15	
X. XXX±0.05	

1.25mm PITCH
90° WAFER-SMT TYPE

DRAW NO. :	REV. :
A12514WR-S-XPNXXXXXXXXR	A5

REV.	DESCRIPTION	DATE	NAME
A5	EN202206071082	2022.06.08	徐貴湖
A4	EN202204201026	2022.04.14	徐貴湖
A3	EN20220331988	2022.02.18	徐貴湖
A2	EN20210312583	2021.04.22	鄭小嬌
A1	EN20210113550	2021.03.23	鄭小嬌
A0	NEW RELEASE	2020.06.17	鄭小嬌

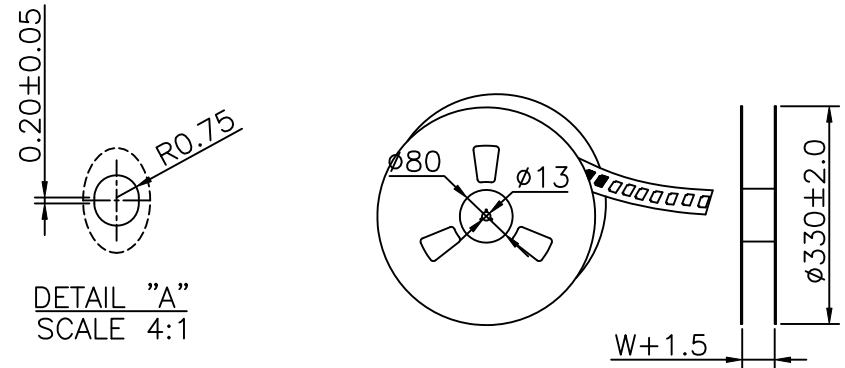
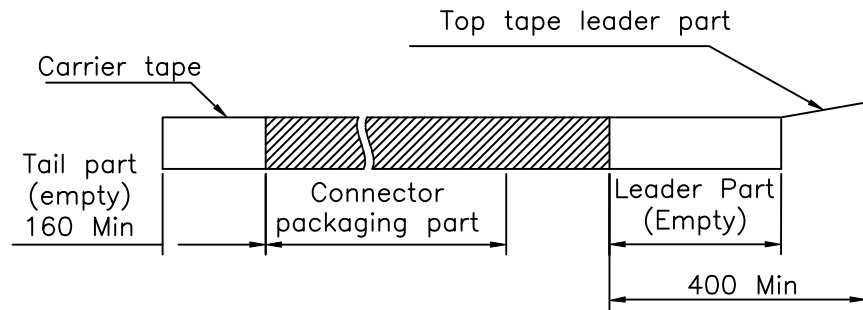
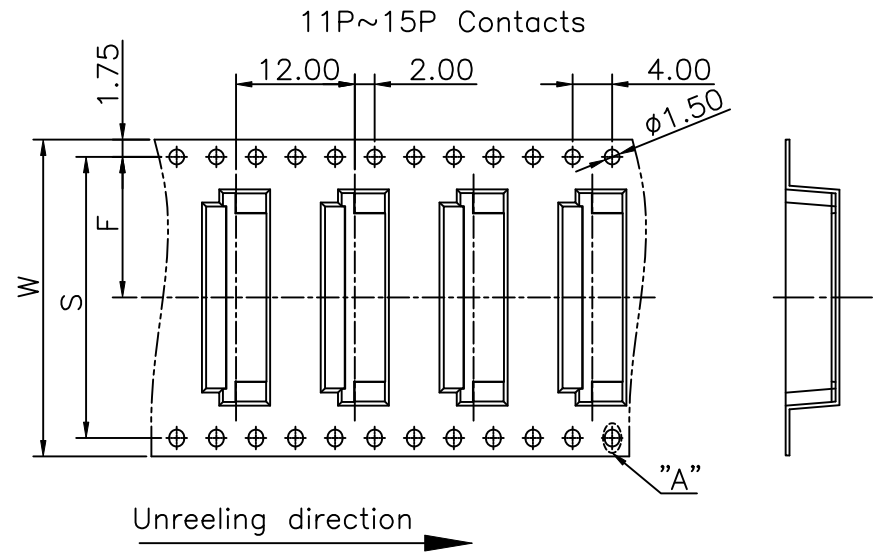
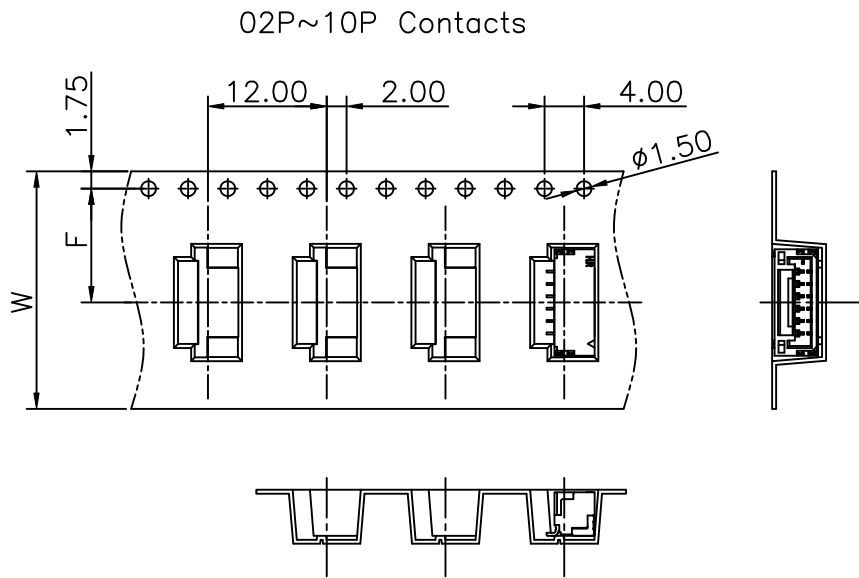

Number of Contacts	W±0.3	F±0.1	S±0.1	Q'ty/Reel
02P	16.00	7.50	/	1,000
03P				
04P				
05P				
06P				
07P	24.00	11.50		
08P				
09P				
10P	32.00	14.20	28.40	
11P				
12P				
13P				
14P				
15P	44.00	20.20	40.40	

				燦達電子工業股份有限公司 JOINT TECH ELECTRONIC IND. CO., LTD.			
		UNIT	SCALE	SHEET	TITLE:		
		mm	1 : 1	3 of 3	1.25mm PITCH 90° WAFER-SMT TYPE TAPING SPEC.		
A5	EN202206071082	2022.06.08	徐貴湖	DRAWN BY			APPROVED BY
A4	EN202204201026	2022.04.14	徐貴湖	徐富永			徐富永
A3	EN20220331988	2022.02.18	徐貴湖	2020.06.17			2020.06.17
A2	EN20210312583	2021.04.22	鄭小嬌	GENERAL TOLERANCE			
A1	EN20210113550	2021.03.23	鄭小嬌	X. X±0.25	ANGLE±		
A0	NEW RELEASE	2020.06.17	鄭小嬌	X. XX±0.15			
REV.	DESCRIPTION	DATE	NAME	X. XXX±0.05		DRAW NO. : A12514WR-S-XPXXXXXXXR	
					REV.	A5	