

PNP General Purpose Amplifier

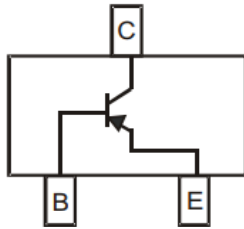

SOT-23

Features

- Epoxy meets UL-94 V-0 flammability rating and halogen free
- Moisture Sensitivity Level 1
- Part no. with suffix "Q" means AEC-Q101 qualified

Mechanical Data

- **Case:** SOT-23
- **Terminals:** Tin plated leads, solderable per J-STD-002 and JESD22-B102
- **Marking:**

	Marking
BC807-16Q	5A
BC807-25Q	5B
BC807-40Q	5C

■ Maximum Ratings (Ta=25°C unless otherwise noted)

Item	Symbol	Unit	Value
Collector-Emitter Voltage	V_{CEO}	V	-45
Collector-Base Voltage	V_{CBO}	V	-50
Emitter-Base Voltage	V_{EBO}	V	-5
Collector Current -Continuous	I_C	mA	-500
Total Device Dissipation (*)	P_D	mW	300
Thermal Resistance Junction to Ambient (*)	R_{thJA}	K/W	417
Junction Temperature	T_j	°C	-55 to +150
Storage Temperature	T_{STG}	°C	-55 to +150

(*) Device mounted on FR-4 PCB 1.0 x 1.0 x 0.06 inch.



BC807-16Q THRU BC807-40Q

RoHS
COMPLIANT

■ Off Characteristics (Ta=25°C unless otherwise noted)

Item	Symbol	Unit	Conditions	Min	Max
Collector-emitter breakdown voltage	V_{CEO}	V	$I_C = -10\text{mA}, I_B = 0$	-45	-
Collector-base breakdown voltage	V_{CBO}	V	$I_C = -10\text{uA}, I_E = 0$	-50	-
Emitter-base breakdown voltage	V_{EBO}	V	$I_E = -1.0\text{uA}, I_C = 0$	-5.0	-
Emitter cut-off current	I_{EBO}	μA	$V_{EB} = -4.0\text{Vdc}, I_C = 0$	-	-0.1
Collector cut-off current	I_{CBO}	μA	$V_{CB} = -45\text{Vdc}, I_E = 0$	-	-0.1
Collector cut-off current	I_{CEO}	μA	$V_{CE} = -40\text{Vdc}, I_B = 0$	-	-0.2

■ On Characteristics (Ta=25°C unless otherwise noted)

Item	Symbol	Unit	Conditions	Min	Max
DC Current Gain	h_{FE}	-	$I_C = -100\text{mA}, V_{CE} = -1.0\text{Vdc}$	100	250
				160	400
				250	600
DC Current Gain	h_{FE}	-	$I_C = -500\text{mA}, V_{CE} = -1.0\text{Vdc}$	40	-
Collector-emitter Saturation Voltage	$V_{CE(sat)}$	V	$I_C = -500\text{mA}, I_B = -50\text{mA}$	-	-0.7
Base-emitter Saturation Voltage	$V_{BE(sat)}$	V	$I_C = -500\text{mA}, I_B = -50\text{mA}$	-	-1.2

■ Small-signal Characteristics (Ta=25°C unless otherwise noted)

Item	Symbol	Unit	Conditions	Min	Max
Current Gain-bandwidth Product	f_T	MHz	$I_C = -10\text{mA}, V_{ce} = -5.0\text{Vdc}, f = 100\text{MHz}$	100	-

■ Ordering Information (Example)

PREFERRED P/N	PACKING CODE	UNIT WEIGHT(g)	MINIMUM PACKAGE(pcs)	INNER BOX QUANTITY(pcs)	OUTER CARTON QUANTITY(pcs)	DELIVERY MODE
BC807-16Q THRU BC807-40Q	F2	Approximate 0.01	3000	30000	120000	7" reel



■ Characteristics (Typical)

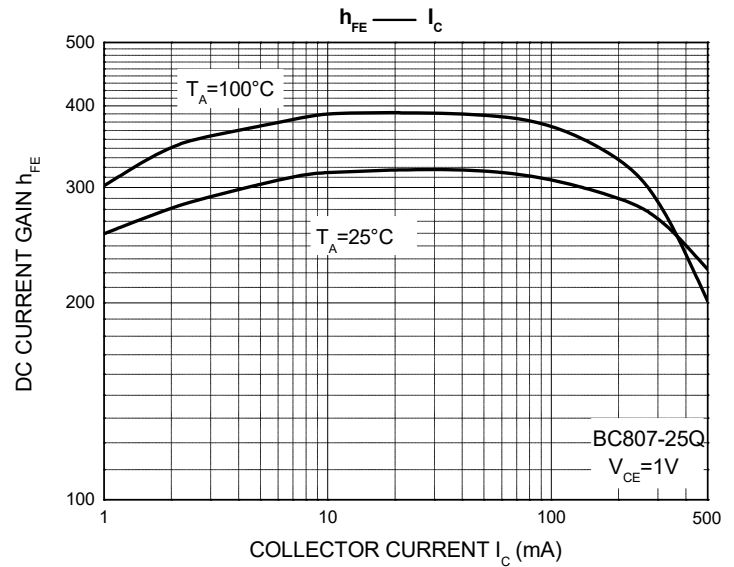
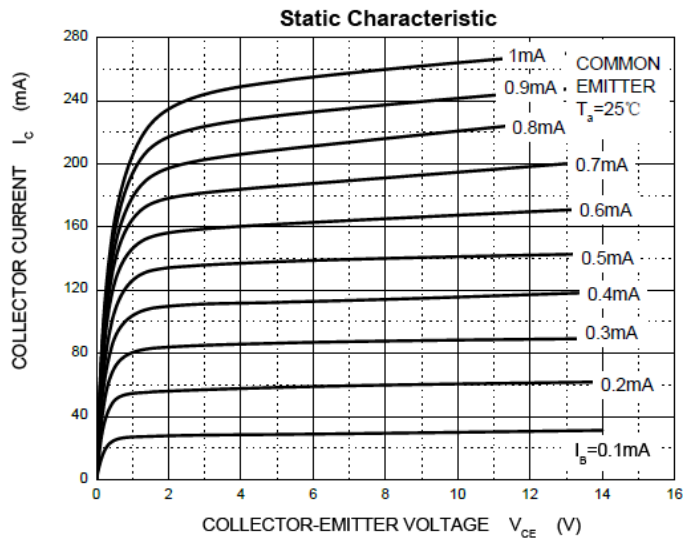
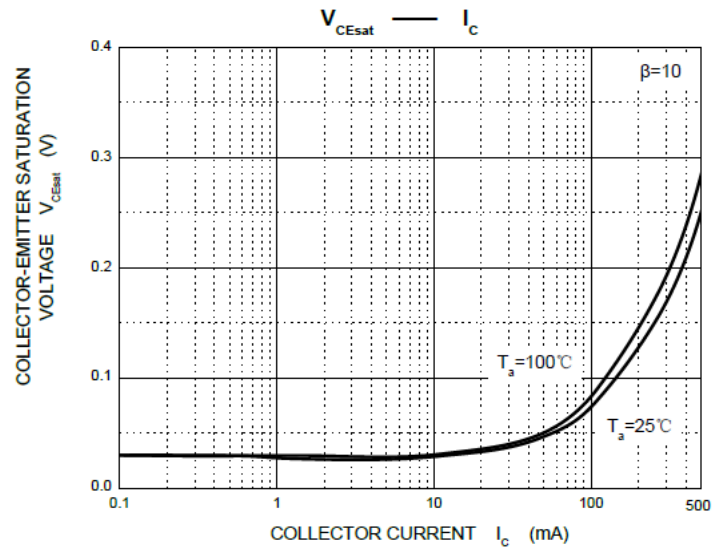
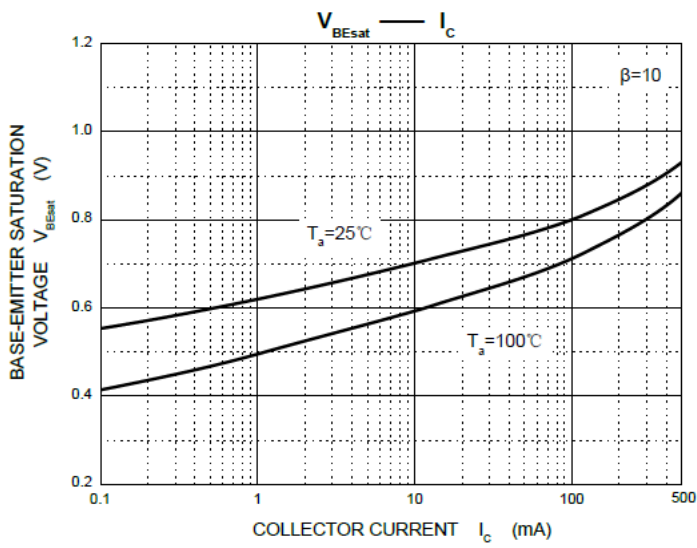

■ SOT-23 Package Outline Dimensions

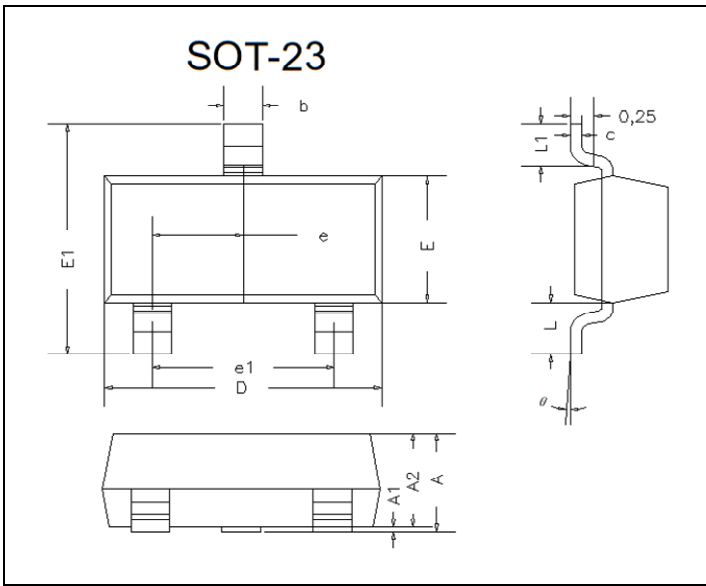

DIM	INCHES		MM		NOTE
	MIN	MAX	MIN	MAX	
A	0.035	0.045	0.90	1.15	
A1	0.000	0.004	0.00	0.10	
A2	0.035	0.041	0.90	1.05	
b	0.012	0.020	0.30	0.50	
c	0.004	0.008	0.10	0.20	
D	0.110	0.118	2.80	3.00	
E	0.047	0.055	1.20	1.40	
E1	0.089	0.100	2.25	2.55	
e	0.370TYP		0.95TYP		
e1	0.071	0.079	1.80	2.00	
L	0.220REF		0.55REF		
L1	0.012	0.020	0.30	0.50	
θ	0°	8°	0°	8°	

■ SOT-23 Suggested Pad Layout

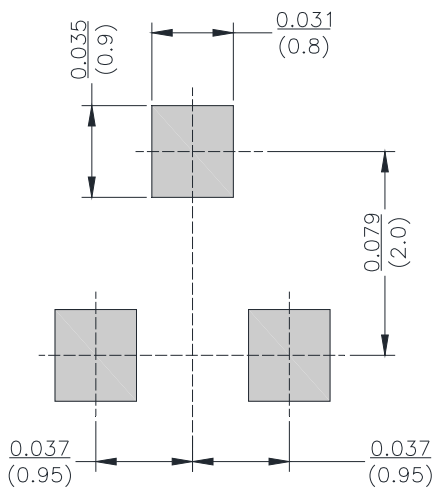

Unit: $\frac{\text{inch}}{\text{mm}}$



■ Marking Information

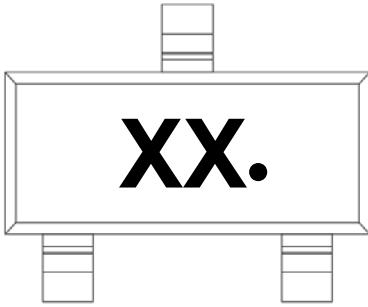

Note:

1. All marking is at middle of the product body
2. All marking is in laser marking
3. XX is Marking Code determined by specific model
4. Body color: Black



Disclaimer

The information presented in this document is for reference only. Yangzhou Yangjie Electronic Technology Co., Ltd. reserves the right to make changes without notice for the specification of the products displayed herein to improve reliability, function or design or otherwise.

The product listed herein is designed to be used with automotive electronics, are not designed for use in medical, life-saving, life-sustaining, or military. Yangjie or anyone on its behalf, assumes no responsibility or liability for any damages resulting from such improper use of sale.

This publication supersedes & replaces all information previously supplied. For additional information, please visit our website [http:// www.21yangjie.com](http://www.21yangjie.com) , or consult your nearest Yangjie's sales office for further assistance.