

# SMT Air Coil Inductor

AIAC-4125C

RoHS  
Compliant

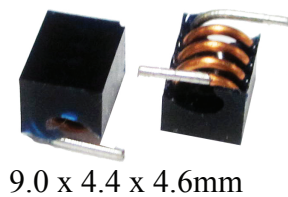

9.0 x 4.4 x 4.6mm

## FEATURES:

- High current design
- Wide Range Frequency Response
- Excellent Q & SRF
- Standard flat cap top suitable for automatic placement.

## APPLICATIONS:

- Widely used in Cordless Phones, High Frequency Communication Equipments, Intercom, CATV,RFID
- Suitable for metal sensors and proximity sensors
- Noise suppression for RF power supply/bias
- I/O filtering, frequency selection for audio devices such as Loudspeakers,Hifi
- Impedance Matching for transceivers
- Improves switch isolation for RF circuit

## STANDARD SPECIFICATIONS:

PARAMETERS	
ABRACON P/N:	AIAC-4125C
Operating temperature:	-40 °C ~ +125 °C
Storage temperature:	-25°C to + 60°C

Part Number	Inductance	Tolerance	DCR (Max)	Q(Min)	SRF(Min)	Rated Current (Max)	Inductance Code
Units	nH	%	mΩ		GHz	A	
Symbol	L	J	DCR			IDC	
AIAC-4125C-R090	90	J	14.0	100	1.0	3.5	R090
AIAC-4125C-R111	111	J	9.5	100	1.0	3.5	R111
AIAC-4125C-R130	130	J	10.8	100	0.9	3.0	R130
AIAC-4125C-R169	169	J	12.0	100	0.8	3.0	R169
AIAC-4125C-R206	206	J	10.5	100	0.7	3.0	R206
AIAC-4125C-R222	222	J	14.0	100	0.6	3.0	R222
AIAC-4125C-R246	246	J	17.0	100	0.6	3.0	R246
AIAC-4125C-R307	307	J	22.0	100	0.5	3.0	R307
AIAC-4125C-R380	380	J	25.5	100	0.5	2.5	R380
AIAC-4125C-R422	422	J	39.0	100	0.4	2.5	R422
AIAC-4125C-R491	491	J	40.0	100	0.4	2.0	R491
AIAC-4125C-R538	538	J	42.0	100	0.4	2.0	R538

## Test Conditions and equipments

Test frequency: 50MHz

Equipment: HP4191A

## PART IDENTIFICATION:

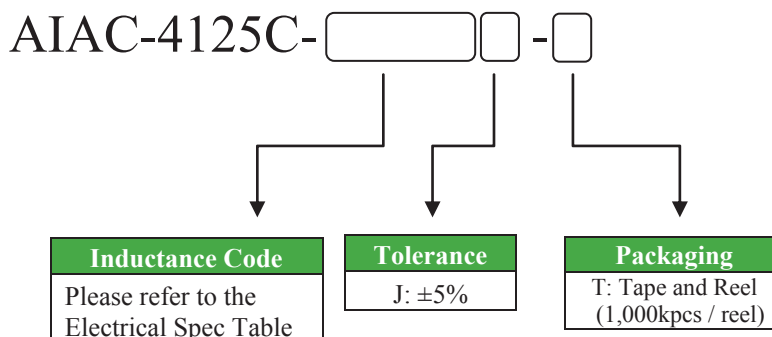

# SMT Air Coil Inductor

AIAC-4125C

**RoHS**  
Compliant

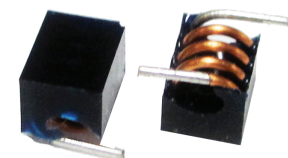

9.0 x 4.4 x 4.6mm

## OUTLINE DRAWING:

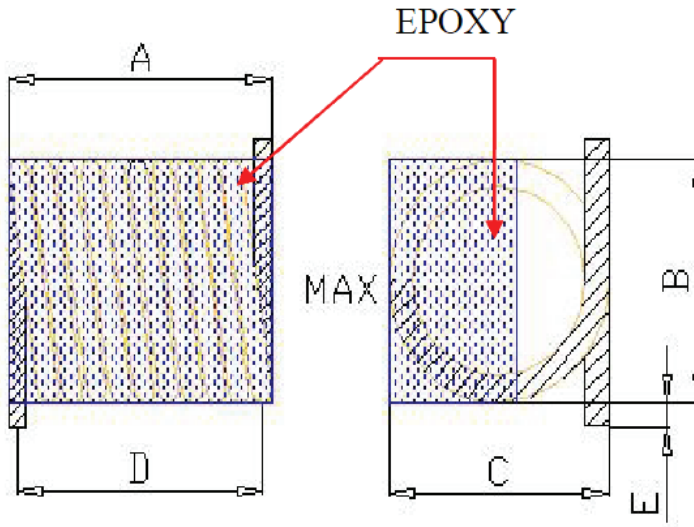

A	B	C	D	E
9.0 max	4.4±0.3	4.6±0.4	8.0±0.5	1.3±0.4

Schematic

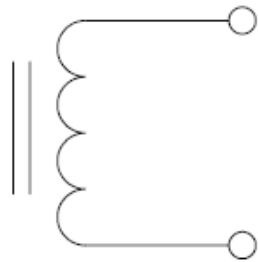

Recommended Land Pattern

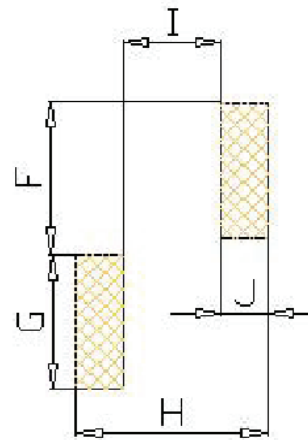

F	G	H	I	J
2.4	4.7	10.0	6.0	2.1

Dimension: mm

# SMT Air Coil Inductor

AIAC-4125C

RoHS  
Compliant

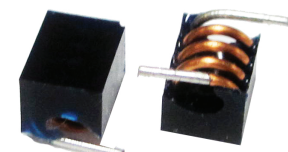

9.0 x 4.4 x 4.6mm

## REFLOW PROFILE:

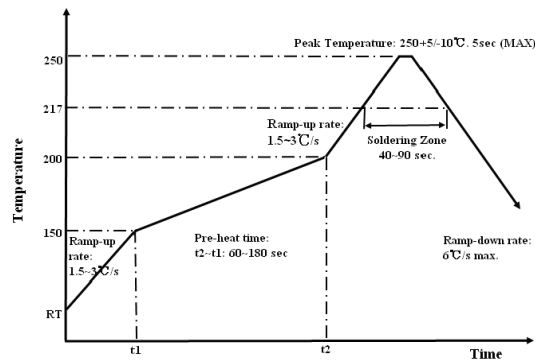

## TAPE & REEL:

Packing  
T: 1,000pcs / reel

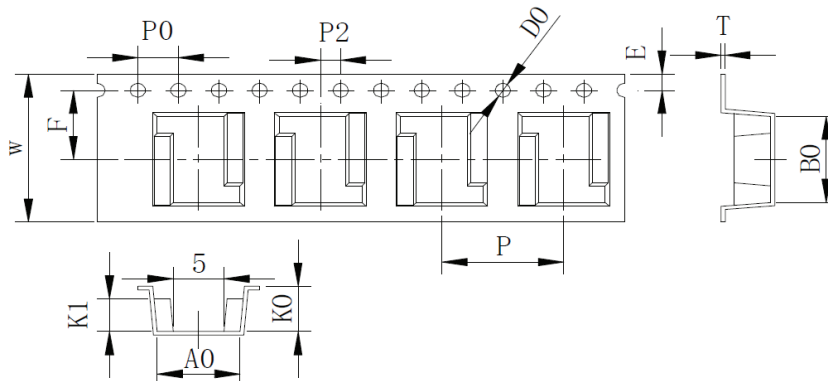

W	A0	B0	K0	K1	P	F	E	D0	P0	P2	T
16.0±0.3	8.2±0.1	9.3±0.1	4.9±0.1	3.6±0.1	12.00±0.1	7.5±0.1	1.75±0.1	1.5+0.1/-0	4.0±0.1	2.0±0.1	0.40±0.05

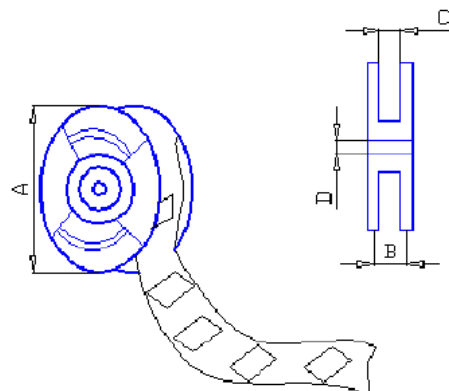

A	330
B	22
C	16
D	13.5

Dimension: mm

**ATTENTION:** Abracon Corporation's products are COTS – Commercial-Off-The-Shelf products; suitable for Commercial, Industrial and, where designated, Automotive Applications. Abracon's products are not specifically designed for Military, Aviation, Aerospace, Life-dependant Medical applications or any application requiring high reliability where component failure could result in loss of life and/or property. For applications requiring high reliability and/or presenting an extreme operating environment, written consent and authorization from Abracon Corporation is required. Please contact Abracon Corporation for more information.

ABRACON IS  
ISO 9001:2008  
CERTIFIED



Visit [www.abracon.com](http://www.abracon.com) for Terms & Conditions of Sale  
30332 Esperanza, Rancho Santa Margarita, California 92688  
tel 949-546-8000 | fax 949-546-8001 | [www.abracon.com](http://www.abracon.com)

Revised: 11.20.12

# Mouser Electronics

Authorized Distributor

Click to View Pricing, Inventory, Delivery & Lifecycle Information:

## ABRACON:

[AIAC-4125C-R222J-T](#) [AIAC-4125C-R422J-T](#) [AIAC-4125C-R246J-T](#) [AIAC-4125C-R130J-T](#) [AIAC-4125C-R491J-T](#)  
[AIAC-4125C-R090J-T](#) [AIAC-4125C-R169J-T](#) [AIAC-4125C-R538J-T](#) [AIAC-4125C-R307J-T](#) [AIAC-4125C-R206J-T](#)  
[AIAC-4125C-R111J-T](#) [AIAC-4125C-R380J-T](#)