

Order No.: 1043789

Type: FP 0,8/ 52-MV-SH 1,15

shielded SMD male connector, Reflow soldering

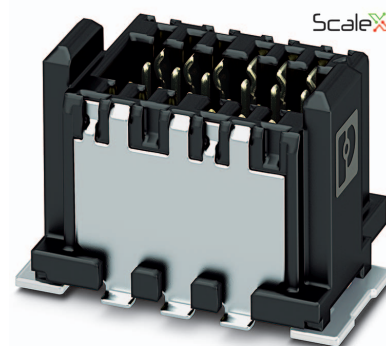

The figure shows a 12-pos. version with 12 contacts

1 Main features

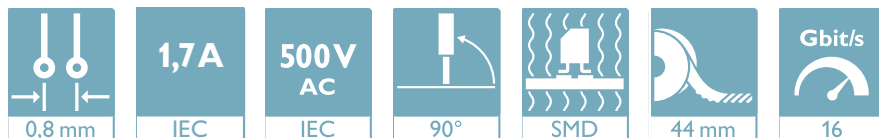

- | | | | |
|----------------|--------------|------------------------|-----------------|
| • No. of pos. | 52 | • Nominal current | 1.7 A |
| • Test voltage | 500 V AC | • Mounting type | SMD soldering |
| • Color | black (9005) | • Connection direction | 90 ° |
| • Pitch | 0.8 mm | • Type of packaging | 44 mm wide tape |

2 Your advantages

- ✓ Gold-plated contacts ensure transfer quality remains stable over the long term
- ✓ Reliable mechanical and electrical connections, thanks to the double-sided ScaleX contact system
- ✓ Robustness: ScaleX technology for high tolerance compensation and protection of contacts
- ✓ Flexible device design: various numbers of positions, designs, and stack heights with high wipe lengths



Make sure you always use the latest documentation.

It can be downloaded at: phoenixcontact.net/product/1043789

3 Table of contents

1	Main features.....	1
2	Your advantages	1
3	Table of contents	2
4	3D model in PDF can be activated (Acrobat Reader only).....	3
5	General Technical Data	4
	5.1 item properties	4
	5.2 Material data	4
6	Dimensions.....	5
	6.1 Dimensions for the product	5
	6.2 Dimensions for the application	5
7	Series drawing.....	6
8	Packaging information	7
9	Blister drawing.....	8
10	Application.....	9
	10.1 Temperature limit values	9
11	General tests	10
	11.1 Specification.....	10
12	Mechanical tests.....	11
	12.1 Insertion and withdrawal force per contact	11
	12.2 Service life	11
13	Electrical tests	12
	13.1 Electrical data	12
	13.2 Air and creepage distances	12
14	Current carrying capacity/derating curves	13
	14.1 Insulation resistance.....	13
	14.2 forward resistance	13
15	Data transmission.....	14
	15.1 Data transmission rate	14
16	Approvals	14
17	Commercial Data.....	15
18	Combination tests.....	16

1043789 FP 0,8/ 52-MV-SH 1,15

4 3D model in PDF can be activated (Acrobat Reader only)



1043789 FP 0,8/ 52-MV-SH 1,15**5 General Technical Data****5.1 item properties**

Order No.	1043789
Type	FP 0,8/ 52-MV-SH 1,15
Plug-in system	Fine Pitch 0,8 mm
Product type	shielded SMD male connector
Type of contact	Male connector
Range of articles	FP 0,8/...-MV-SH 1,15
Pitch	0.8 mm
Range of positions	12...80
Number of positions	52
Number of levels	2
Number of potentials	52
Mounting type	SMD soldering
Connection direction of the connector to the PCB	90 °

5.2 Material data

Material of metal parts	
Note	WEEE/RoHS-compliant, whisker-free acc. to IEC 60068-2-82/JEDEC JESD 201
Contact material	Cu alloy
Surface contact area	Nickel (Ni) , , Gold (Au)
Soldering area surface	Nickel (Ni) , Tin (Sn)
Surface characteristics	Selective coating
Insulating material data	
Insulating material	LCP
Insulating material group	IIIa
CTI according to IEC 60112	150
Flammability rating according to UL 94	V0
Color	black (9005)

1043789 FP 0,8/ 52-MV-SH 1,15**6 Dimensions****6.1 Dimensions for the product**

Length	6.1 mm
Width	24.7 mm
Total height	6.25 mm
Height	5.65 mm
Base height	1.15 mm
Positioning pin geometry	, Length of positioning pin: 0.6 mm
Coplanarity	≤ 0.1 mm

6.2 Dimensions for the application

Contact cover	0.8 mm
Overlap length	1.5 mm
Medium offset	± 0.7 mm in longitudinal and transverse direction
Angular tolerance	± 2 ° in longitudinal direction
Angular tolerance	± 4 ° in transverse direction
Stacking height	6 mm Tolerance: +1,5 mm (in combination with Range of articles:FP 0,8/...-FV-SH 4,85)
Stacking height	9 mm Tolerance: +1,5 mm (in combination with Range of articles:FP 0,8/...-FV-SH 7,85)

1043789 FP 0,8/ 52-MV-SH 1,15

7 Series drawing

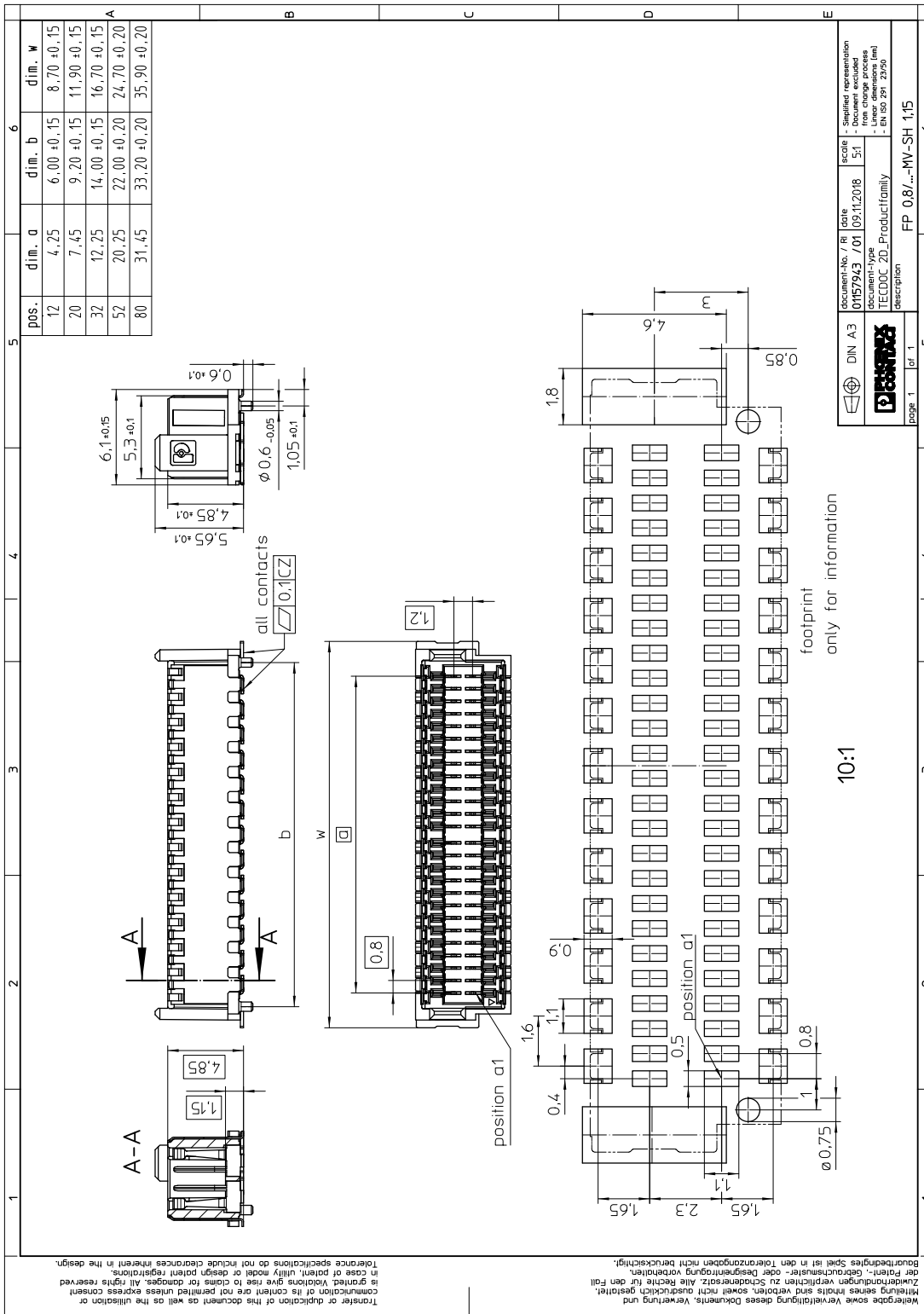

1043789 FP 0,8/ 52-MV-SH 1,15**8 Packaging information**

Type of packaging	44 mm wide tape
Pieces per package	500
Outer packaging type	Transparent-Bag
[W] tape width	44.4 mm
[A] coil diameter	330 mm
[W2] coil overall dimension	50.4 mm
Number of products per coil	500

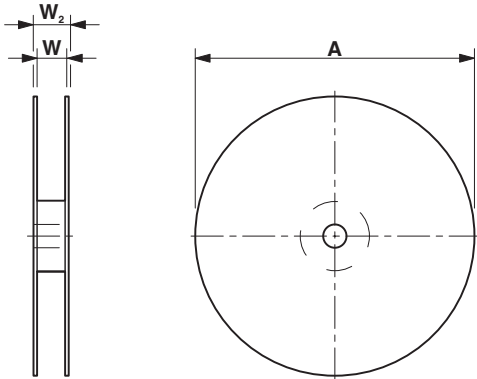

1043789 FP 0,8/ 52-MV-SH 1,15

9 Blister drawing

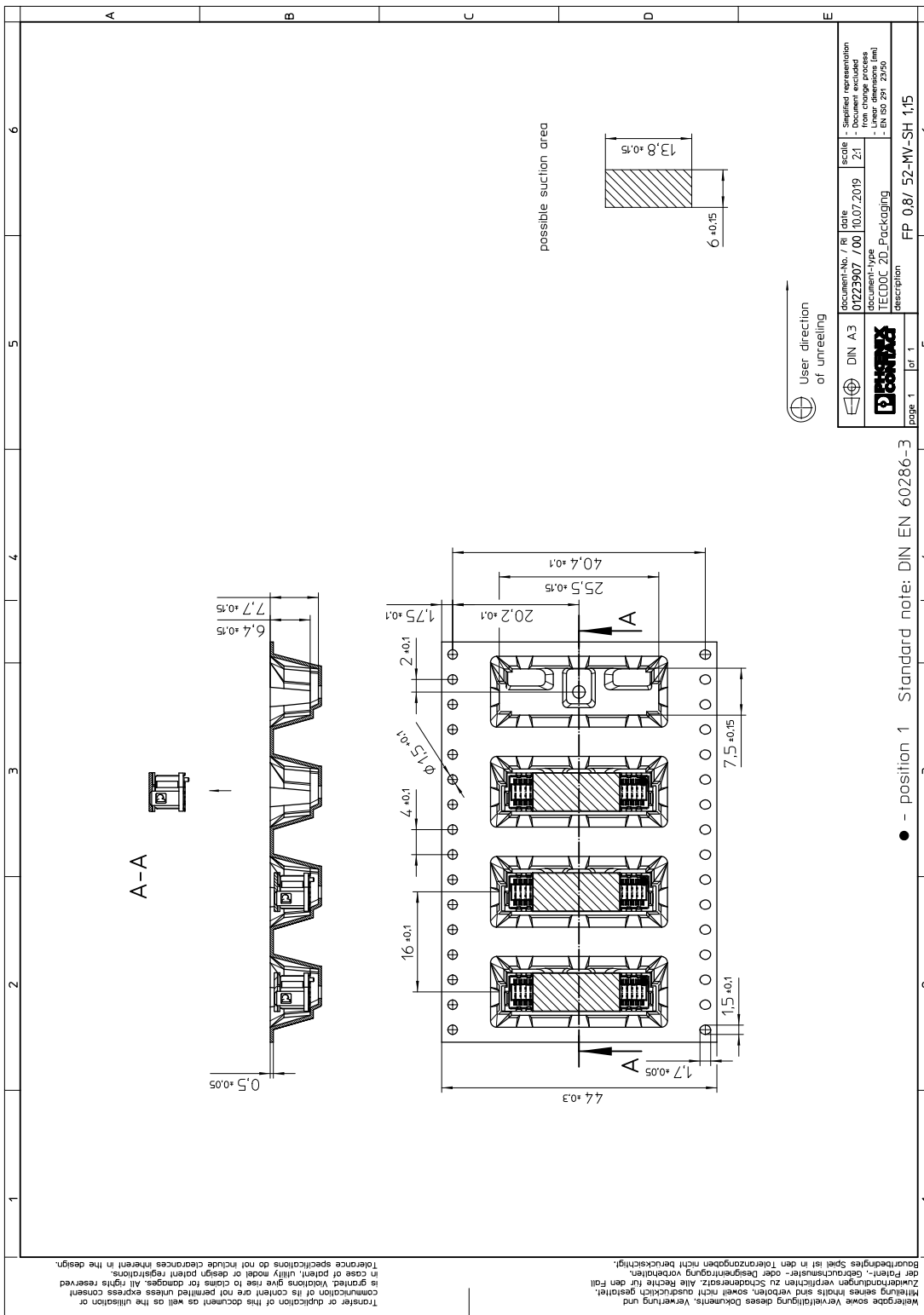

10 Application

10.1 Temperature limit values

Ambient temperature (storage/transport)	-40 °C ... 70 °C
Ambient temperature (assembly)	-5 °C ... 100 °C
Ambient temperature (operation)	-55 °C ... 125 °C

11 General tests

11.1 Specification

Brief description

Board-to-board connectors

1043789 FP 0,8/ 52-MV-SH 1,15**12 Mechanical tests****12.1 Insertion and withdrawal force per contact**

Insertion and withdrawal force per contact	≤ 1.2 N
--	---------

12.2 Service life

Specification	IEC 60512-9-1:2010-03 (following)
Service life	500 Insertion/withdrawal cycles, Performance level 1

1043789 FP 0,8/ 52-MV-SH 1,15**13 Electrical tests****13.1 Electrical data**

Nominal current at 20 °C	1.7 A (52-pos.)
Test voltage	500 V AC IEC 60512-4-1:2003

13.2 Air and creepage distances

Minimum value for clearance and creepage distance	0.25 mm
---	---------

1043789 FP 0,8/ 52-MV-SH 1,15

14 Current carrying capacity/derating curves**14.1 Insulation resistance**

Insulation resistance $\geq 5 \text{ G}\Omega$, (IEC 60512-3-1:2002-02)

14.2 forward resistance

Contact resistance $\leq 20 \text{ m}\Omega$, (IEC 60512-2-1:2002-02)

1043789 FP 0,8/ 52-MV-SH 1,15

15 Data transmission

15.1 Data transmission rate



Data rate

up to 16 Gbps

16 Approvals

1043789 FP 0,8/ 52-MV-SH 1,15**17 Commercial Data**

Order No.	1043789
Type	FP 0,8/ 52-MV-SH 1,15
Pieces per package	500
Net weight	2.22 g
GTIN	4055626608372
	Information that applies locally, see link on page 1
Country of origin	Information that applies locally, see link on page 1

1043789 FP 0,8/ 52-MV-SH 1,15

18 Combination tests

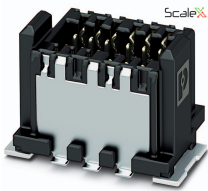

FP 0,8/...-MV-SH 1,15



FP 0,8/...-FV 4,85

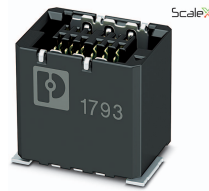

FP 0,8/...-FV-SH 7,85

Mechanical tests				
Durability tests				
Contact resistance R_1	20 m Ω	20 m Ω		
Insertion/withdrawal cycles	500	500		
Contact resistance R_2	20 m Ω	20 m Ω		
Thermal tests				