

2W, Fixed input voltage, isolated & unregulated single output

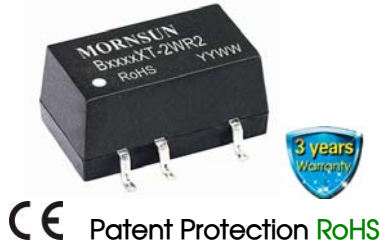

FEATURES

- Operating temperature range: -40°C to +105°C
- High efficiency up to 84%
- Miniature SMD package
- Isolation voltage: 1.5K VDC
- Internal surface mounted design
- No external component required
- International standard pin-out

B_XT-2WR2 series are specially designed for applications where an isolated voltage is required in a distributed power supply system. They are suitable for

1. Where the voltage of the input power supply is stable (voltage variation: $\pm 10\%V_{in}$);
2. Where isolation between input and output is necessary (isolation voltage $\leq 1500VDC$);
3. Where the output voltage regulation and the ripple & noise of the output voltage is not strictly required;
4. Typical application: preceding-stage interference isolation condition; ground-interference canceled condition; digit circuit condition; Voltage-isolation converting condition; normal low-frequency artificial circuit condition; relay drive circuit condition, etc.

Selection Guide

Certification	Part No.	Input Voltage (VDC)	Output		Efficiency (%Min./Typ.) @ Full Load	Max. Capacitive Load (μF)
		Nominal (Range)	Output Voltage (VDC)	Output Current (mA)(Max./Min.)		
CE	B0503XT-2WR2	5 (4.5-5.5)	3.3	400/40	74/78	220
	B0505XT-2WR2		5	400/40	75/79	
	B0509XT-2WR2		9	222/22	78/82	
	B0512XT-2WR2		12	167/17	78/82	
	B0515XT-2WR2		15	133/13	79/83	
	B1205XT-2WR2	12 (10.8-13.2)	5	400/40	75/79	
	B1209XT-2WR2		9	222/22	78/82	
	B1212XT-2WR2		12	167/17	78/82	
	B1215XT-2WR2		15	133/13	79/83	
	B1224XT-2WR2		24	83/8	80/84	
	B1515XT-2WR2	15 (13.5-16.5)	15	133/13	79/83	
	B2405XT-2WR2	24 (21.6-26.4)	5	400/40	75/79	
	B2409XT-2WR2		9	222/22	78/82	
	B2412XT-2WR2		12	167/17	78/82	
	B2415XT-2WR2		15	133/13	79/83	
	B2424XT-2WR2		24	83/8	80/84	

Input Specifications

Item	Operating Conditions	Min.	Typ.	Max.	Unit
Input Current (full load / no-load)	5V input	--	506/30	--/60	mA
	12V input	--	212/25	--/50	
	15V input	--	169/18	--/35	
	24V input	--	105/15	--/30	
Reflected Ripple Current		--	15	--	mA
Surge Voltage (1sec. max.)	5V input	-0.7	--	9	VDC
	12V input	-0.7	--	18	
	15V input	-0.7	--	21	
	24V input	-0.7	--	30	
Input Filter		Filter capacitor			
Hot Plug		Unavailable			

Output Specifications

Item	Operating Conditions		Min.	Typ.	Max.	Unit
Output Voltage Accuracy			See tolerance envelope graph (Fig. 1)			
Line Regulation	Input voltage change: $\pm 1\%$	3.3VDC output	--	--	± 1.5	--
		Other output	--	--	± 1.2	
Load Regulation	10%-100% load	3.3VDC output	--	18	--	%
		5VDC output	--	12	--	
		9VDC output	--	9	--	
		12VDC output	--	8	--	
		15VDC output	--	7	--	
		24VDC output	--	6	--	
Ripple & Noise*	20MHz bandwidth	24VDC output	--	100	200	mVp-p
		Other output	--	100	150	
Temperature Coefficient	Full load		--	--	± 0.03	%/°C
Short Circuit Protection**			--	--	1	s

Note: * Ripple and noise are measured by "parallel cable" method, please see DC-DC Converter Application Notes for specific operation;
** Supply voltage must be discontinued at the end of short circuit duration.

General Specifications

Item	Operating Conditions		Min.	Typ.	Max.	Unit
Isolation Voltage	Input-output, with the test time of 1 minute and the leak current lower than 1mA		1500	--	--	VDC
Isolation Resistance	Input-output, isolation voltage 500VDC		1000	--	--	MΩ
Isolation Capacitance	Input-output, 100KHz/0.1V		--	20	--	pF
Operating Temperature	5V output	Derating if the temperature $\geq 71^\circ\text{C}$, (see Fig. 2)	-40	--	105	°C
	Other output	Derating if the temperature $\geq 85^\circ\text{C}$, (see Fig. 2)				
Storage Temperature			-55	--	125	
Casing Temperature Rise	$T_a=25^\circ\text{C}$, nominal input, full load output		--	25	--	
Pin Welding Resistance Temperature	Welding spot is 1.5mm away from the casing, 10 seconds		--	--	300	
Storage Humidity	Non-condensing		--	--	95	
Reflow Soldering Temperature			Peak temp. $\leq 245^\circ\text{C}$, maximum duration time $\leq 60\text{s}$ at 217°C . For actual application, please refer to IPC/JEDEC J-STD-020D.1.			
Switching Frequency	Full load, nominal input voltage		--	100	--	KHz
MTBF	MIL-HDFK-217F@25°C		3500	--	--	K hours

Physical Specifications

Casing Material	Epoxy resin (UL94-V0)
Dimensions	12.70*11.20*7.25 mm
Weight	1.6g(Typ.)
Cooling Method	Free convection

EMC Specifications

EMI	CE	CISPR22/EN55022 CLASS B (see Fig. 4 for recommended circuit)
	RE	CISPR22/EN55022 CLASS B (see Fig. 4 for recommended circuit)
EMS	ESD	IEC/EN61000-4-2 Contact $\pm 8\text{KV}$ perf. Criteria B

Product Characteristic Curve

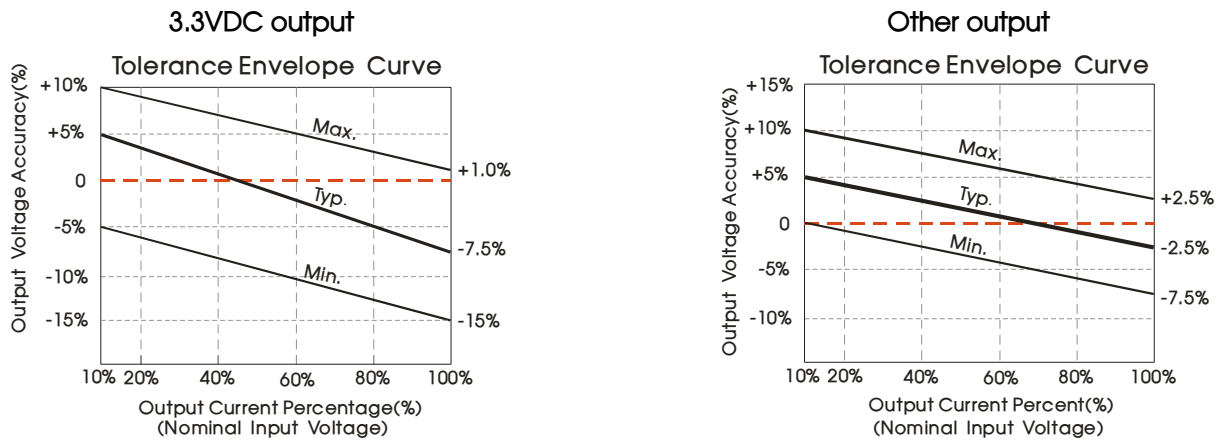

Fig. 1

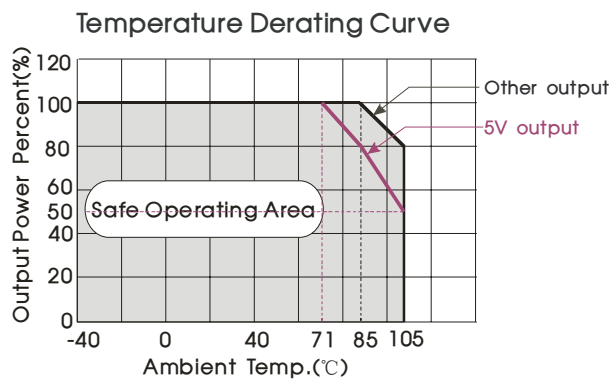
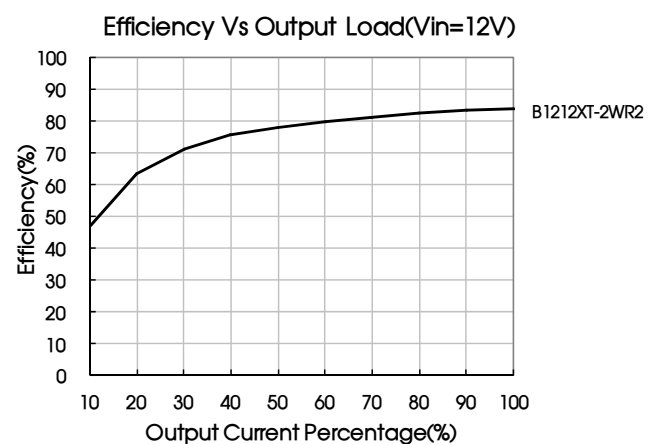
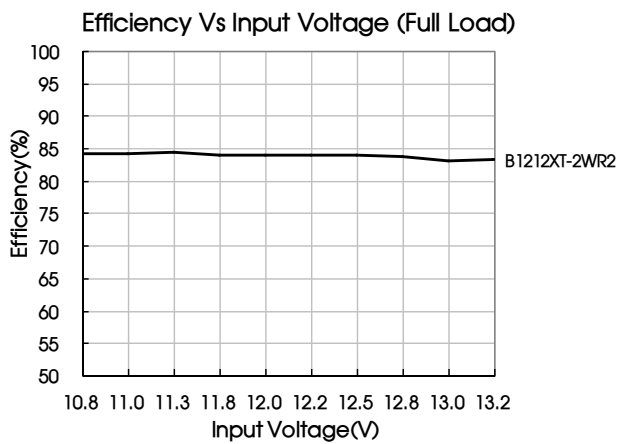
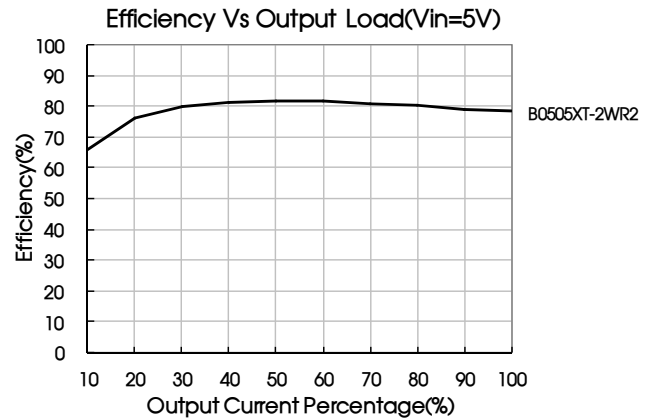
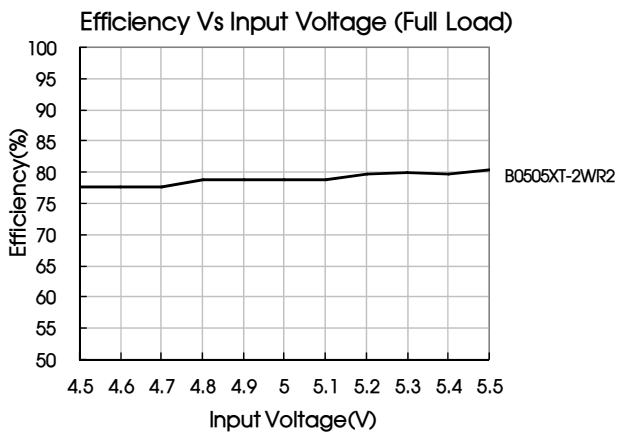

Fig. 2



Design Reference

1. Typical application circuit

If it is required to further reduce input and output ripple, a filter capacitor may be connected to the input and output terminals, see Fig.3. Moreover, choosing a suitable filter capacitor is very important, start-up problems may be caused if the capacitance is too large. Under the condition of safe and reliable operation, the recommended capacitive load values are shown in Table 1.

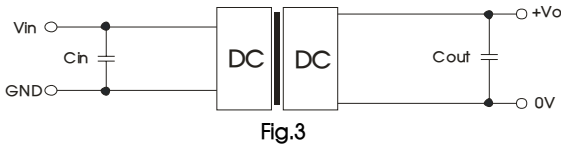

Recommended capacitive load value table (Table 1)

Vin(VDC)	Cin(μF)	Vo (VDC)	Cout(μF)
5	4.7	3.3	10
12	2.2	5	10
15	2.2	9	4.7
24	1	12	2.2
--	--	15	1
--	--	24	0.47

2. EMC solution-recommended circuit

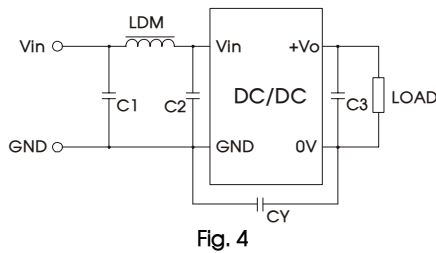

Input voltage (VDC)	5/12/15	24
EMI	C1	4.7μF /50V
	C2	4.7μF /50V
	C3	Refer to the Cout in Fig.3
	CY	-- 1nF/2KV
	LDM	6.8μH

Notes: 1. 24V input series, 24V output series is subject to CY (CY : 1nF/2KV).
2. It is not needed to add the component in the peripheral circuit when parameter with the symbol of "--".

3. Output load requirements

When using, the minimum load of the module output should not be less than 10% of the nominal load. In order to meet the performance parameters of this datasheet, please connect a 10% dummy load in parallel at the output end, the dummy load is generally a resistor, Please note that the resistor needs to be used in derating.

4. For more information please find DC-DC converter application notes on www.mornsun-power.com

Dimensions and Recommended Layout

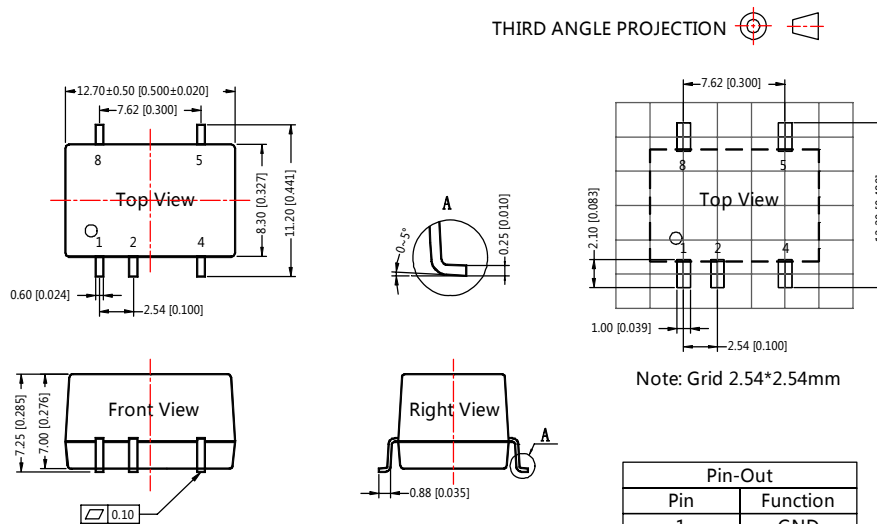

Note:
Unit: mm[inch]
Pin section tolerances: ±0.10[±0.004]
General tolerances: ±0.25[±0.010]

Note: Grid 2.54*2.54mm

Pin	Function
1	GND
2	Vin
4	0V
5	+Vo
8	NC

NC: No Connection

Notes:

1. Packing information please refer to Product Packing Information which can be downloaded from www.mornsun-power.com. Packing bag number: 58210024;
2. If the product is not operated within the required load range, the product performance cannot be guaranteed to comply with all parameters in the datasheet;
3. The maximum capacitive load offered were tested at nominal input voltage and full load;
4. Unless otherwise specified, parameters in this datasheet were measured under the conditions of $T_a=25\text{ }^\circ\text{C}$, humidity<75% with nominal input voltage and rated output load;
5. All index testing methods in this datasheet are based on our Company's corporate standards;
6. The performance parameters of the product models listed in this manual are as above, but some parameters of non-standard model products may exceed the requirements mentioned above. Please contact our technicians directly for specific information;
7. We can provide product customization service;
8. Specifications are subject to change without prior notice.

MORNSUN Guangzhou Science & Technology Co., Ltd.

Address: No. 5, Kehui St. 1, Kehui Development Center, Science Ave., Guangzhou Science City, Luogang District, Guangzhou, P. R. China
Tel: 86-20-38601850-8801 Fax: 86-20-38601272 E-mail: info@mornsun.cn