

COSMO High Voltage, Solid State Relay-MOSFET Output KAQW614/614A

UL 1577/ UL 508 (File No.E108430), FI EN60950 (File No.FI13698)

Features

1. Normally Open and Close, Single Pole Single Throw
2. Control 400VAC or DC Voltage
3. Switch 130mA Loads
4. LED control Current, 5mA
5. Low ON-Resistance
6. dv/dt , >500V/ms
7. Isolation Test Voltage, 3750VACrms

Absolute Maximum Ratings

($T_a=25^\circ\text{C}$)

Emitter (Input)	
Reverse Voltage	5.0V
Continuous Forward Current	50mA
Peak Forward Current	1A
Power Dissipation	100mW
Derate Linearly from 25°C	1.3mW/°C
Detector (Output)	
Output Breakdown Voltage	±400V
Continuous Load Current	±130mA
Power Dissipation	500mW
General Characteristics	
Isolation Test Voltage	3750VACrms
Isolation Resistance $V_{io}=500V, T_a=25^\circ\text{C}$	$\geq 10^{10} \Omega$
Total Power Dissipation	550mW
Derate Linearly from 25°C	2.5mW/°C
Storage Temperature Range	-40°C to +125°C
Operating Temperature Range	-30°C to +85°C
Junction Temperature	100°C
Soldering Temperature, 2mm from case, 10 sec	260°C

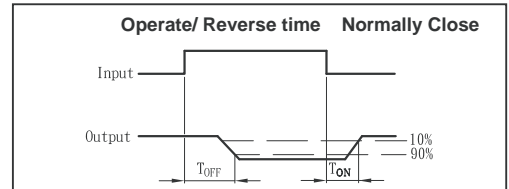
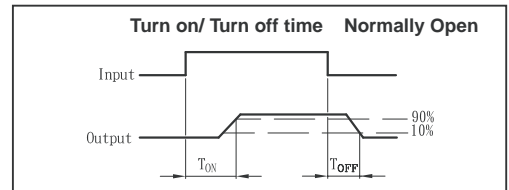
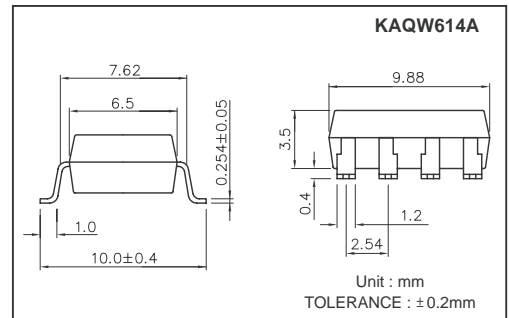
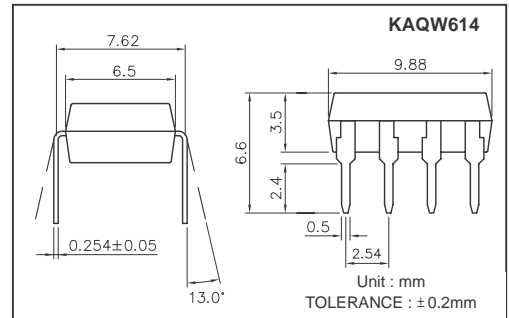

Electro-optical Characteristics

(Ta=25°C)

Parameter	Symbol	Conditions	Min.	T yp.	Max.	Unit
Emitter (Input)						
Forward Voltage	V _F	I _F = 10mA		1.2	1.5	V
Operation Input Current	I _{FON(N.O)} I _{FOFF(N.C)}	V _L = ±20V, I _L = 100mA (N.O) V _L = ±20V, I _L ≤ 5uA (N.C) t = 10mS			5	mA
Recovery Input Current	I _{FOFF(N.O)} I _{FON(N.C)}	V _L = ±20V, I _L ≤ 5uA (N.O) V _L = ±20V, I _L = 100mA (N.C) t = 10mS	0.2			mA

Detector (Output) normally open						
Output Breakdown Voltage	V _B	I _B = 50uA	400			V
Output Off-State Leakage	I _{TOFF}	V _T = 100V, I _F = 0mA		0.2	1	uA
I/O Capacitance	C _{ISO}	I _F = 0, f = 1MHz		6		pF
ON Resistance	R _{ON}	I _L = 100mA, I _F = 10mA		20	30	Ω
Turn-On Time	T _{ON}	I _F = 10mA, V _L = ±20V		0.3	1.0	ms
Turn-Off Time	T _{OFF}	t = 10ms, I _L = ±100mA		0.7	1.5	ms

Detector (Output) normally close						
Output Breakdown Voltage	V _B	I _B = 50uA	400			V
Output Off-State Leakage	I _{TOFF}	V _T = 100V, I _F = 10mA		0.2	2	uA
I/O Capacitance	C _{ISO}	I _F = 0, f = 1MHz		6		pF
ON Resistance	R _{ON}	I _L = 100mA, I _F = 10mA		40	50	Ω
Reverse (ON) Time	T _{ON}	I _F = 10mA, V _L = ±20V		0.6	1.5	ms
Operate (OFF) Time	T _{OFF}		t = 10ms, I _L = ±100mA	0.3	1.0	ms

Schematic and Wiring Diagrams

Type	Schematic	Output configuration	Load	Connection	Wiring Diagrams
KAQW614 & KAQW614A		1a1b	AC/DC	-	<p>(1) Two independent 1 Form A & 1 Form B use</p> <p>(2) 1 Form A & 1 Form B use</p>

Data Curve (KAQW614/614A Normally Close Characteristics)

Fig.1 Load current vs. ambient temperature
Allowable ambient temperature:
-40°C to +85°C

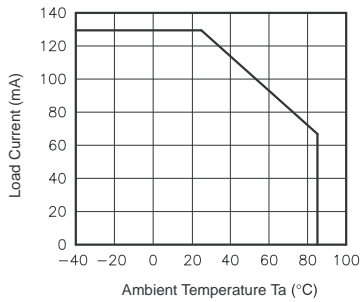

Fig.2 On resistance vs. ambient temperature
Across terminals 7 and 8 pin
LED current: 0mA
Continuous load current: 130mA(DC)

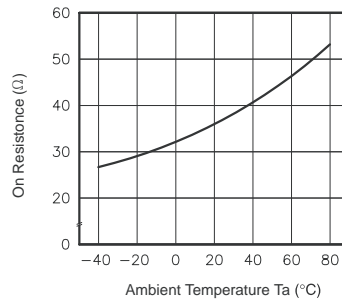

Fig.3 Operate (OFF) time vs. ambient temperature
Load voltage 400V(DC)
LED current: 5mA
Continuous load current: 130mA(DC)

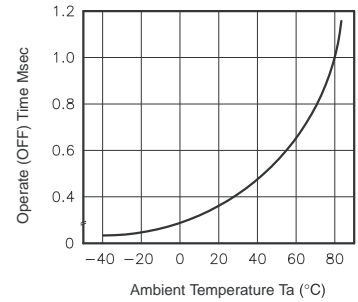

Fig.4 Reverse (ON) time vs. ambient temperature
LED current: 5mA;
Load voltage: 400V(DC)
Continuous load current: 130mA(DC)

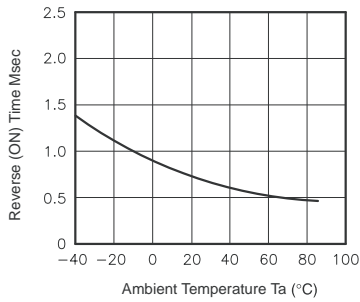

Fig.5 LED operate (OFF) vs. ambient temperature
Load voltage 400V(DC)
Continuous load current: 130mA(DC)

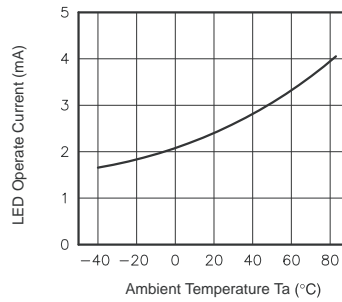

Fig.6 LED Reverse (ON) current vs. ambient temperature
Load voltage 400V(DC)
Continuous load current: 130mA(DC)

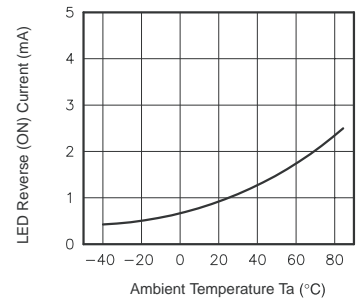

Fig.7 LED dropout voltage vs. ambient temperature
LED current: 5 to 50mA

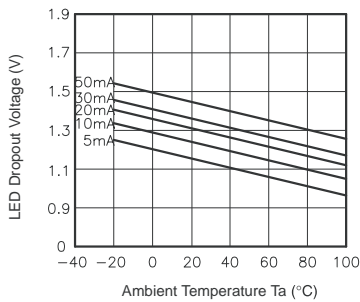

Fig.8 Voltage vs. current characteristics of output at MOS FET portion
Measured portion: across terminals 7 and 8 pin
Ambient temperature: 25°C

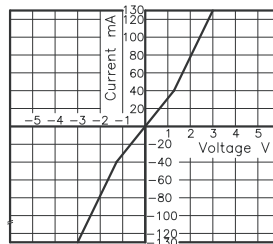

Fig.9 Off state leakage current
Across terminals 7 and 8 pin
Ambient temperature: 25°C

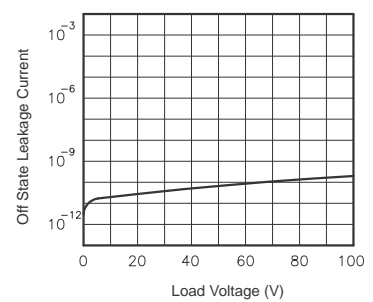

Fig.10 LED forward current vs. turn on time
Across terminals 7 and 8 pin;
Load voltage: 400V (DC);
Continuous load current: 130mA (DC);
Ambient temperature: 25°C

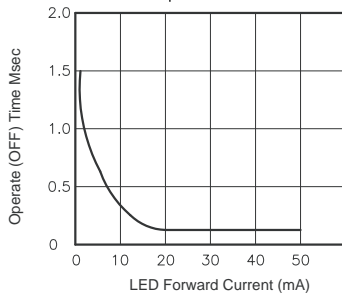

Fig.11 LED forward current vs. reverse time
Across terminals 7 and 8 pin;
Load voltage: 400V (DC); Continuous load current: 130mA (DC); Ambient temperature: 25°C

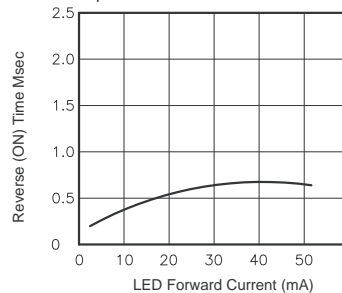
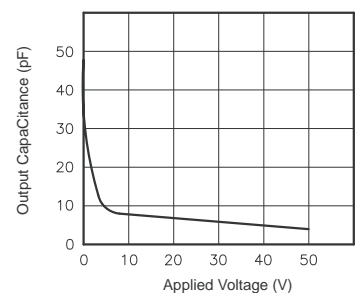

Fig.12 Applied voltage vs. output capacitance
Across terminals 7 and 8 pin
Frequency: 1MHz
Ambient temperature: 25°C



This datasheet has been download from:

www.datasheetcatalog.com

Datasheets for electronics components.