

**Preliminary datasheet**

**EconoPIM™2 module with TRENCHSTOP™ IGBT7 and Emitter Controlled 7 diode and NTC**

**Features**

- Electrical features
  - $V_{CES} = 1200\text{ V}$
  - $I_{C\text{nom}} = 50\text{ A} / I_{CRM} = 100\text{ A}$
  - TRENCHSTOP™ IGBT7
  - Low  $V_{CESat}$
  - Overload operation up to  $175^\circ\text{C}$
- Mechanical features
  - High power and thermal cycling capability
  - Integrated NTC temperature sensor
  - Copper base plate
  - $\text{Al}_2\text{O}_3$  substrate with low thermal resistance
  - Solder contact technology

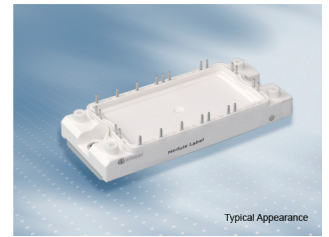

**Potential applications**

- Auxiliary inverters
- Motor drives
- Servo drives

**Product validation**

- Qualified for industrial applications according to the relevant tests of IEC 60747, 60749 and 60068

**Description**

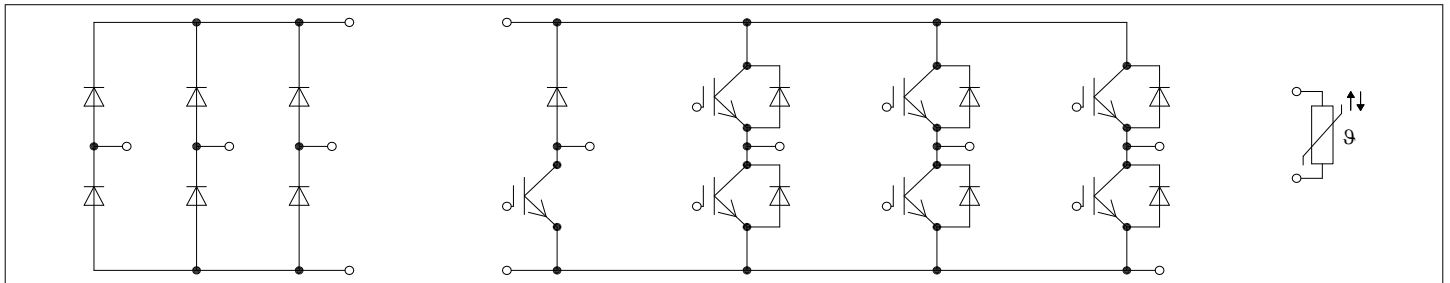

## Table of contents

	<b>Description</b> .....	1
	<b>Features</b> .....	1
	<b>Potential applications</b> .....	1
	<b>Product validation</b> .....	1
	<b>Table of contents</b> .....	2
<b>1</b>	<b>Package</b> .....	3
<b>2</b>	<b>IGBT, Inverter</b> .....	3
<b>3</b>	<b>Diode, Inverter</b> .....	5
<b>4</b>	<b>Diode, Rectifier</b> .....	6
<b>5</b>	<b>IGBT-Chopper</b> .....	7
<b>6</b>	<b>Diode, Chopper</b> .....	8
<b>7</b>	<b>NTC-Thermistor</b> .....	9
<b>8</b>	<b>Characteristics diagrams</b> .....	11
<b>9</b>	<b>Circuit diagram</b> .....	17
<b>10</b>	<b>Package outlines</b> .....	18
<b>11</b>	<b>Module label code</b> .....	19
	<b>Revision history</b> .....	20
	<b>Disclaimer</b> .....	21

## 1 Package

**Table 1** Insulation coordination

Parameter	Symbol	Note or test condition	Values	Unit
Isolation test voltage	$V_{ISOL}$	RMS, $f = 50 \text{ Hz}$ , $t = 1 \text{ min}$	2.5	kV
Material of module baseplate			Cu	
Internal Isolation		basic insulation (class 1, IEC 61140)	$\text{Al}_2\text{O}_3$	
Creepage distance	$d_{Creep}$	terminal to heatsink	10.0	mm
Clearance	$d_{Clear}$	terminal to heatsink	7.5	mm
Comparative tracking index	$CTI$		> 200	
RTI Elec.	$RTI$	housing	140	°C

**Table 2** Characteristic values

Parameter	Symbol	Note or test condition	Values			Unit
			Min.	Typ.	Max.	
Stray inductance module	$L_{SCE}$			35		nH
Module lead resistance, terminals - chip	$R_{AA'+CC'}$	$T_C = 25^\circ\text{C}$ , per switch		5.5		mΩ
Module lead resistance, terminals - chip	$R_{CC'+EE'}$	$T_C = 25^\circ\text{C}$ , per switch		4.8		mΩ
Storage temperature	$T_{stg}$		-40		125	°C
Mounting torque for modul mounting	$M$	- Mounting according to valid application note	M5, Screw	3	6	Nm
Weight	$G$			180		g

## 2 IGBT, Inverter

**Table 3** Maximum rated values

Parameter	Symbol	Note or test condition	Values	Unit
Collector-emitter voltage	$V_{CES}$	$T_{vj} = 25^\circ\text{C}$	1200	V
Continous DC collector current	$I_{CDC}$	$T_{vj \text{ max}} = 175^\circ\text{C}$ $T_C = 100^\circ\text{C}$	50	A
Repetitive peak collector current	$I_{CRM}$	$t_p = 1 \text{ ms}$	100	A
Gate-emitter peak voltage	$V_{GES}$		±20	V

**Table 4** Characteristic values

Parameter	Symbol	Note or test condition	Values			Unit	
			Min.	Typ.	Max.		
Collector-emitter saturation voltage	$V_{CE\ sat}$	$I_C = 50\ A, V_{GE} = 15\ V$	$T_{vj} = 25\ ^\circ C$		1.50	TBD	V
			$T_{vj} = 125\ ^\circ C$		1.64		
			$T_{vj} = 175\ ^\circ C$		1.72		
Gate threshold voltage	$V_{GEth}$	$I_C = 2\ mA, V_{CE} = V_{GE}, T_{vj} = 25\ ^\circ C$		5.15	5.80	6.45	V
Gate charge	$Q_G$	$V_{GE} = \pm 15\ V, V_{CE} = 600\ V$			0.92		$\mu C$
Internal gate resistor	$R_{Gint}$	$T_{vj} = 25\ ^\circ C$			0		$\Omega$
Input capacitance	$C_{ies}$	$f = 1000\ kHz, T_{vj} = 25\ ^\circ C, V_{CE} = 25\ V, V_{GE} = 0\ V$			11.1		nF
Reverse transfer capacitance	$C_{res}$	$f = 1000\ kHz, T_{vj} = 25\ ^\circ C, V_{CE} = 25\ V, V_{GE} = 0\ V$			0.039		nF
Collector-emitter cut-off current	$I_{CES}$	$V_{CE} = 1200\ V, V_{GE} = 0\ V$	$T_{vj} = 25\ ^\circ C$			0.01	mA
Gate-emitter leakage current	$I_{GES}$	$V_{CE} = 0\ V, V_{GE} = 20\ V, T_{vj} = 25\ ^\circ C$				100	nA
Turn-on delay time (inductive load)	$t_{don}$	$I_C = 50\ A, V_{CE} = 600\ V, V_{GE} = \pm 15\ V, R_{Gon} = 7.5\ \Omega$	$T_{vj} = 25\ ^\circ C$		0.059		$\mu s$
			$T_{vj} = 125\ ^\circ C$		0.061		
			$T_{vj} = 175\ ^\circ C$		0.062		
Rise time (inductive load)	$t_r$	$I_C = 50\ A, V_{CE} = 600\ V, V_{GE} = \pm 15\ V, R_{Gon} = 7.5\ \Omega$	$T_{vj} = 25\ ^\circ C$		0.043		$\mu s$
			$T_{vj} = 125\ ^\circ C$		0.047		
			$T_{vj} = 175\ ^\circ C$		0.049		
Turn-off delay time (inductive load)	$t_{doff}$	$I_C = 50\ A, V_{CE} = 600\ V, V_{GE} = \pm 15\ V, R_{Goff} = 7.5\ \Omega$	$T_{vj} = 25\ ^\circ C$		0.290		$\mu s$
			$T_{vj} = 125\ ^\circ C$		0.380		
			$T_{vj} = 175\ ^\circ C$		0.420		
Fall time (inductive load)	$t_f$	$I_C = 50\ A, V_{CE} = 600\ V, V_{GE} = \pm 15\ V, R_{Goff} = 7.5\ \Omega$	$T_{vj} = 25\ ^\circ C$		0.110		$\mu s$
			$T_{vj} = 125\ ^\circ C$		0.200		
			$T_{vj} = 175\ ^\circ C$		0.270		
Turn-on energy loss per pulse	$E_{on}$	$I_C = 50\ A, V_{CE} = 600\ V, L_\sigma = 35\ nH, V_{GE} = \pm 15\ V, R_{Gon} = 7.5\ \Omega, di/dt = 900\ A/\mu s (T_{vj} = 175\ ^\circ C)$	$T_{vj} = 25\ ^\circ C$		5.07		mJ
			$T_{vj} = 125\ ^\circ C$		6.76		
			$T_{vj} = 175\ ^\circ C$		7.72		
Turn-off energy loss per pulse	$E_{off}$	$I_C = 50\ A, V_{CE} = 600\ V, L_\sigma = 35\ nH, V_{GE} = \pm 15\ V, R_{Goff} = 7.5\ \Omega, dv/dt = 2900\ V/\mu s (T_{vj} = 175\ ^\circ C)$	$T_{vj} = 25\ ^\circ C$		3.37		mJ
			$T_{vj} = 125\ ^\circ C$		5.31		
			$T_{vj} = 175\ ^\circ C$		6.58		
SC data	$I_{SC}$	$V_{GE} \leq 15\ V, V_{CC} = 800\ V, V_{CEmax} = V_{CES} - L_{sCE} * di/dt$	$t_p \leq 8\ \mu s, T_{vj} = 150\ ^\circ C$		190		A
			$t_p \leq 7\ \mu s, T_{vj} = 175\ ^\circ C$		180		

**Table 4** Characteristic values (continued)

Parameter	Symbol	Note or test condition	Values			Unit
			Min.	Typ.	Max.	
Thermal resistance, junction to case	$R_{thJC}$	per IGBT			0.579	K/W
Thermal resistance, case to heatsink	$R_{thCH}$	per IGBT, $\lambda_{grease} = 1 \text{ W}/(\text{m}^2\text{K})$		0.147		K/W
Temperature under switching conditions	$T_{vj\text{op}}$		-40		175	°C

Note:  $T_{vj\text{op}} > 150^\circ\text{C}$  is allowed for operation at overload conditions. For detailed specifications, please refer to AN 2018-14.

### 3 Diode, Inverter

**Table 5** Maximum rated values

Parameter	Symbol	Note or test condition	Values	Unit	
Repetitive peak reverse voltage	$V_{RRM}$	$T_{vj} = 25^\circ\text{C}$	1200	V	
Continuous DC forward current	$I_F$		50	A	
Repetitive peak forward current	$I_{FRM}$	$t_P = 1 \text{ ms}$	100	A	
$I^2t$ - value	$I^2t$	$t_P = 10 \text{ ms}, V_R = 0 \text{ V}$	$T_{vj} = 125^\circ\text{C}$	465	$\text{A}^2\text{s}$
			$T_{vj} = 175^\circ\text{C}$	420	

**Table 6** Characteristic values

Parameter	Symbol	Note or test condition	Values			Unit	
			Min.	Typ.	Max.		
Forward voltage	$V_F$	$I_F = 50 \text{ A}, V_{GE} = 0 \text{ V}$	$T_{vj} = 25^\circ\text{C}$		1.72	TBD	V
			$T_{vj} = 125^\circ\text{C}$		1.59		
			$T_{vj} = 175^\circ\text{C}$		1.52		
Peak reverse recovery current	$I_{RM}$	$V_R = 600 \text{ V}, I_F = 35 \text{ A}, V_{GE} = -15 \text{ V}, -di_F/dt = 900 \text{ A}/\mu\text{s} (T_{vj} = 175^\circ\text{C})$	$T_{vj} = 25^\circ\text{C}$		31		A
			$T_{vj} = 125^\circ\text{C}$		39		
			$T_{vj} = 175^\circ\text{C}$		45		
Recovered charge	$Q_r$	$V_R = 600 \text{ V}, I_F = 50 \text{ A}, V_{GE} = -15 \text{ V}, -di_F/dt = 900 \text{ A}/\mu\text{s} (T_{vj} = 175^\circ\text{C})$	$T_{vj} = 25^\circ\text{C}$		3.96		$\mu\text{C}$
			$T_{vj} = 125^\circ\text{C}$		7.37		
			$T_{vj} = 175^\circ\text{C}$		9.89		

**Table 6** Characteristic values (continued)

Parameter	Symbol	Note or test condition	Values			Unit
			Min.	Typ.	Max.	
Reverse recovery energy	$E_{rec}$	$V_R = 600\text{ V}$ , $I_F = 50\text{ A}$ , $V_{GE} = -15\text{ V}$ , $-di_F/dt = 900\text{ A}/\mu\text{s}$ ( $T_{vj} = 175\text{ °C}$ )	$T_{vj} = 25\text{ °C}$	1.31		mJ
			$T_{vj} = 125\text{ °C}$	2.52		
			$T_{vj} = 175\text{ °C}$	3.46		
Thermal resistance, junction to case	$R_{thJC}$	per diode			0.900	K/W
Thermal resistance, case to heatsink	$R_{thCH}$	per diode, $\lambda_{grease} = 1\text{ W}/(\text{m}^*\text{K})$		0.168		K/W
Temperature under switching conditions	$T_{vj\text{ op}}$		-40		175	°C

Note:  $T_{vj\text{ op}} > 150\text{ °C}$  is allowed for operation at overload conditions. For detailed specifications, please refer to AN 2018-14.

## 4 Diode, Rectifier

**Table 7** Maximum rated values

Parameter	Symbol	Note or test condition	Values	Unit	
Repetitive peak reverse voltage	$V_{RRM}$	$T_{vj} = 25\text{ °C}$	1600	V	
Maximum RMS forward current per chip	$I_{FRMSM}$	$T_C = 80\text{ °C}$	70	A	
Maximum RMS current at rectifier output	$I_{RMSM}$	$T_C = 80\text{ °C}$	100	A	
Surge forward current	$I_{FSM}$	$t_p = 10\text{ ms}$	$T_{vj} = 25\text{ °C}$	560	A
			$T_{vj} = 150\text{ °C}$	435	
$I^2t$ - value	$I^2t$	$t_p = 10\text{ ms}$	$T_{vj} = 25\text{ °C}$	1570	$\text{A}^2\text{s}$
			$T_{vj} = 150\text{ °C}$	945	

**Table 8** Characteristic values

Parameter	Symbol	Note or test condition	Values			Unit
			Min.	Typ.	Max.	
Forward voltage	$V_F$	$I_F = 50\text{ A}$ , $T_{vj} = 150\text{ °C}$		1.05		V
Reverse current	$I_r$	$T_{vj} = 150\text{ °C}$ , $V_R = 1600\text{ V}$		1		mA
Thermal resistance, junction to case	$R_{thJC}$	per diode			0.870	K/W
Thermal resistance, case to heatsink	$R_{thCH}$	per diode, $\lambda_{grease} = 1\text{ W}/(\text{m}^*\text{K})$		0.171		K/W

**Table 8** Characteristic values (continued)

Parameter	Symbol	Note or test condition	Values			Unit
			Min.	Typ.	Max.	
Temperature under switching conditions	$T_{vj, op}$		-40		150	°C

## 5 IGBT-Chopper

**Table 9** Maximum rated values

Parameter	Symbol	Note or test condition	Values	Unit
Collector-emitter voltage	$V_{CES}$	$T_{vj} = 25\text{ °C}$	1200	V
Continuous DC collector current	$I_{CDC}$	$T_{vj\ max} = 175\text{ °C}$ $T_C = 100\text{ °C}$	25	A
Repetitive peak collector current	$I_{CRM}$	$t_P = 1\text{ ms}$	50	A
Gate-emitter peak voltage	$V_{GES}$		±20	V

**Table 10** Characteristic values

Parameter	Symbol	Note or test condition	Values			Unit
			Min.	Typ.	Max.	
Collector-emitter saturation voltage	$V_{CE\ sat}$	$I_C = 25\text{ A}, V_{GE} = 15\text{ V}$	$T_{vj} = 25\text{ °C}$	1.60	TBD	V
			$T_{vj} = 125\text{ °C}$	1.74		
			$T_{vj} = 175\text{ °C}$	1.82		
Gate threshold voltage	$V_{GEth}$	$I_C = 0.525\text{ mA}, V_{CE} = V_{GE}, T_{vj} = 25\text{ °C}$	5.15	5.80	6.45	V
Gate charge	$Q_G$	$V_{GE} = \pm 15\text{ V}, V_{CE} = 600\text{ V}$		0.395		µC
Internal gate resistor	$R_{Gint}$	$T_{vj} = 25\text{ °C}$		0		Ω
Input capacitance	$C_{ies}$	$f = 1000\text{ kHz}, T_{vj} = 25\text{ °C}, V_{CE} = 25\text{ V}, V_{GE} = 0\text{ V}$		4.77		nF
Reverse transfer capacitance	$C_{res}$	$f = 1000\text{ kHz}, T_{vj} = 25\text{ °C}, V_{CE} = 25\text{ V}, V_{GE} = 0\text{ V}$		0.017		nF
Collector-emitter cut-off current	$I_{CES}$	$V_{CE} = 1200\text{ V}, V_{GE} = 0\text{ V}$			0.004	mA
Gate-emitter leakage current	$I_{GES}$	$V_{CE} = 0\text{ V}, V_{GE} = 20\text{ V}, T_{vj} = 25\text{ °C}$			100	nA
Turn-on delay time (inductive load)	$t_{don}$	$I_C = 25\text{ A}, V_{CE} = 600\text{ V}, V_{GE} = \pm 15\text{ V}, R_{Gon} = 9.1\text{ }\Omega$	$T_{vj} = 25\text{ °C}$	0.041		µs
			$T_{vj} = 125\text{ °C}$	0.043		
			$T_{vj} = 175\text{ °C}$	0.044		
Rise time (inductive load)	$t_r$	$I_C = 25\text{ A}, V_{CE} = 600\text{ V}, V_{GE} = \pm 15\text{ V}, R_{Gon} = 9.1\text{ }\Omega$	$T_{vj} = 25\text{ °C}$	0.025		µs
			$T_{vj} = 125\text{ °C}$	0.028		
			$T_{vj} = 175\text{ °C}$	0.030		

**Table 10** Characteristic values (continued)

Parameter	Symbol	Note or test condition	Values			Unit
			Min.	Typ.	Max.	
Turn-off delay time (inductive load)	$t_{doff}$	$I_C = 25\text{ A}, V_{CE} = 600\text{ V}, V_{GE} = \pm 15\text{ V}, R_{Goff} = 9.1\ \Omega$	$T_{vj} = 25\text{ }^\circ\text{C}$	0.230		$\mu\text{s}$
			$T_{vj} = 125\text{ }^\circ\text{C}$	0.320		
			$T_{vj} = 175\text{ }^\circ\text{C}$	0.350		
Fall time (inductive load)	$t_f$	$I_C = 25\text{ A}, V_{CE} = 600\text{ V}, V_{GE} = \pm 15\text{ V}, R_{Goff} = 9.1\ \Omega$	$T_{vj} = 25\text{ }^\circ\text{C}$	0.140		$\mu\text{s}$
			$T_{vj} = 125\text{ }^\circ\text{C}$	0.220		
			$T_{vj} = 175\text{ }^\circ\text{C}$	0.280		
Turn-on energy loss per pulse	$E_{on}$	$I_C = 25\text{ A}, V_{CE} = 600\text{ V}, L_\sigma = 35\text{ nH}, V_{GE} = \pm 15\text{ V}, R_{Gon} = 9.1\ \Omega, di/dt = 780\text{ A}/\mu\text{s} (T_{vj} = 175\text{ }^\circ\text{C})$	$T_{vj} = 25\text{ }^\circ\text{C}$	1.47		mJ
			$T_{vj} = 125\text{ }^\circ\text{C}$	2.05		
			$T_{vj} = 175\text{ }^\circ\text{C}$	2.39		
Turn-off energy loss per pulse	$E_{off}$	$I_C = 25\text{ A}, V_{CE} = 600\text{ V}, L_\sigma = 35\text{ nH}, V_{GE} = \pm 15\text{ V}, R_{Goff} = 9.1\ \Omega, dv/dt = 3120\text{ V}/\mu\text{s} (T_{vj} = 175\text{ }^\circ\text{C})$	$T_{vj} = 25\text{ }^\circ\text{C}$	1.65		mJ
			$T_{vj} = 125\text{ }^\circ\text{C}$	2.58		
			$T_{vj} = 175\text{ }^\circ\text{C}$	3.13		
SC data	$I_{SC}$	$V_{GE} \leq 15\text{ V}, V_{CC} = 800\text{ V}, V_{CEmax} = V_{CES} - L_{SCE} \cdot di/dt$	$t_p \leq 8\ \mu\text{s}, T_{vj} = 150\text{ }^\circ\text{C}$	90		A
			$t_p \leq 7\ \mu\text{s}, T_{vj} = 175\text{ }^\circ\text{C}$	85		
Thermal resistance, junction to case	$R_{thJC}$	per IGBT			0.967	K/W
Thermal resistance, case to heatsink	$R_{thCH}$	per IGBT, $\lambda_{grease} = 1\text{ W}/(\text{m}^2\text{K})$		0.171		K/W
Temperature under switching conditions	$T_{vjop}$		-40		175	$^\circ\text{C}$

Note:  $T_{vjop} > 150\text{ }^\circ\text{C}$  is allowed for operation at overload conditions. For detailed specifications, please refer to AN 2018-14.

## 6 Diode, Chopper

**Table 11** Maximum rated values

Parameter	Symbol	Note or test condition	Values	Unit
Repetitive peak reverse voltage	$V_{RRM}$	$T_{vj} = 25\text{ }^\circ\text{C}$	1200	V
Continuous DC forward current	$I_F$		25	A
Repetitive peak forward current	$I_{FRM}$	$t_p = 1\text{ ms}$	50	A



**Table 11** Maximum rated values (continued)

Parameter	Symbol	Note or test condition	Values			Unit
			Min.	Typ.	Max.	
I <sup>2</sup> t - value	I <sup>2</sup> t	t <sub>p</sub> = 10 ms, V <sub>R</sub> = 0 V	T <sub>vj</sub> = 125 °C	125		A <sup>2</sup> s
			T <sub>vj</sub> = 175 °C	95		

**Table 12** Characteristic values

Parameter	Symbol	Note or test condition	Values			Unit
			Min.	Typ.	Max.	
Forward voltage	V <sub>F</sub>	I <sub>F</sub> = 25 A, V <sub>GE</sub> = 0 V	T <sub>vj</sub> = 25 °C	1.83	TBD	V
			T <sub>vj</sub> = 125 °C	1.70		
			T <sub>vj</sub> = 175 °C	1.63		
Peak reverse recovery current	I <sub>RM</sub>	V <sub>R</sub> = 600 V, I <sub>F</sub> = 25 A, V <sub>GE</sub> = -15 V, -di <sub>F</sub> /dt = 395 A/μs (T <sub>vj</sub> = 175 °C)	T <sub>vj</sub> = 25 °C	18		A
			T <sub>vj</sub> = 125 °C	25		
			T <sub>vj</sub> = 175 °C	29		
Recovered charge	Q <sub>r</sub>	V <sub>R</sub> = 600 V, I <sub>F</sub> = 25 A, V <sub>GE</sub> = -15 V, -di <sub>F</sub> /dt = 395 A/μs (T <sub>vj</sub> = 175 °C)	T <sub>vj</sub> = 25 °C	2.79		μC
			T <sub>vj</sub> = 125 °C	3.36		
			T <sub>vj</sub> = 175 °C	4.41		
Reverse recovery energy	E <sub>rec</sub>	V <sub>R</sub> = 600 V, I <sub>F</sub> = 25 A, V <sub>GE</sub> = -15 V, -di <sub>F</sub> /dt = 395 A/μs (T <sub>vj</sub> = 175 °C)	T <sub>vj</sub> = 25 °C	1.36		mJ
			T <sub>vj</sub> = 125 °C	1.54		
			T <sub>vj</sub> = 175 °C	2.03		
Thermal resistance, junction to case	R <sub>thJC</sub>	per diode			1.43	K/W
Thermal resistance, case to heatsink	R <sub>thCH</sub>	per diode, λ <sub>grease</sub> = 1 W/(m*K)		0.182		K/W
Temperature under switching conditions	T <sub>vj op</sub>		-40		175	°C

Note: T<sub>vj op</sub> > 150°C is allowed for operation at overload conditions. For detailed specifications, please refer to AN 2018-14.

## 7 NTC-Thermistor

**Table 13** Characteristic values

Parameter	Symbol	Note or test condition	Values			Unit
			Min.	Typ.	Max.	
Rated resistance	R <sub>25</sub>	T <sub>NTC</sub> = 25 °C		5		kΩ
Deviation of R <sub>100</sub>	ΔR/R	T <sub>NTC</sub> = 100 °C, R <sub>100</sub> = 493 Ω	-5		5	%
Power dissipation	P <sub>25</sub>	T <sub>NTC</sub> = 25 °C			20	mW

**Table 13**                    **Characteristic values (continued)**

Parameter	Symbol	Note or test condition	Values			Unit
			Min.	Typ.	Max.	
B-value	$B_{25/50}$	$R_2 = R_{25} \exp[B_{25/50}(1/T_2 - 1/(298,15 \text{ K}))]$		3375		K
B-value	$B_{25/80}$	$R_2 = R_{25} \exp[B_{25/80}(1/T_2 - 1/(298,15 \text{ K}))]$		3411		K
B-value	$B_{25/100}$	$R_2 = R_{25} \exp[B_{25/100}(1/T_2 - 1/(298,15 \text{ K}))]$		3433		K

Note:                    *Specification according to the valid application note.*

## 8 Characteristics diagrams

**output characteristic (typical), IGBT, Inverter**

$$I_C = f(V_{CE})$$

$$V_{GE} = 15 \text{ V}$$

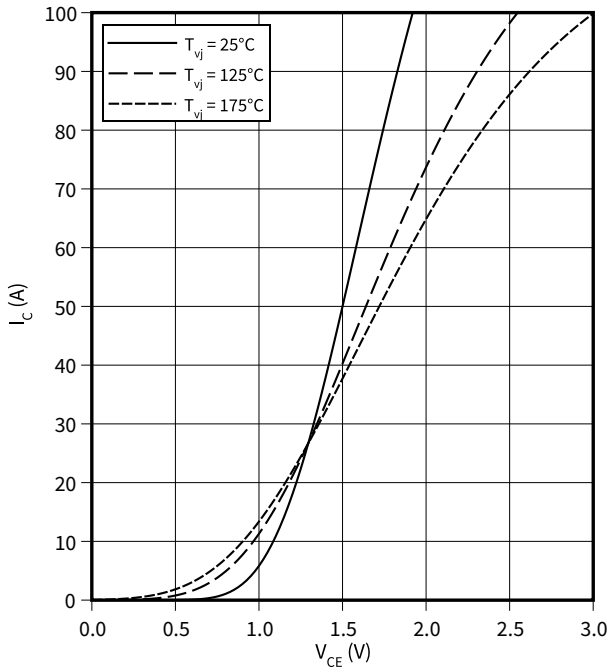

**output characteristic (typical), IGBT, Inverter**

$$I_C = f(V_{CE})$$

$$T_{vj} = 175 \text{ °C}$$

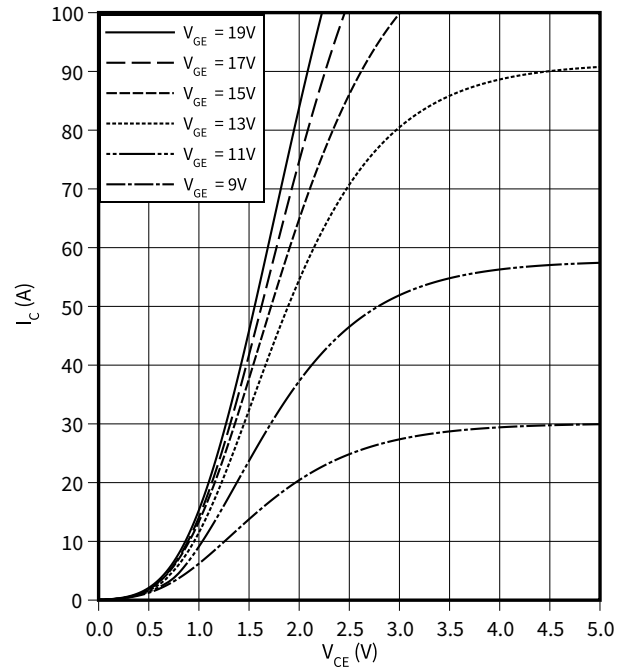

**transfer characteristic (typical), IGBT, Inverter**

$$I_C = f(V_{GE})$$

$$V_{CE} = 20 \text{ V}$$

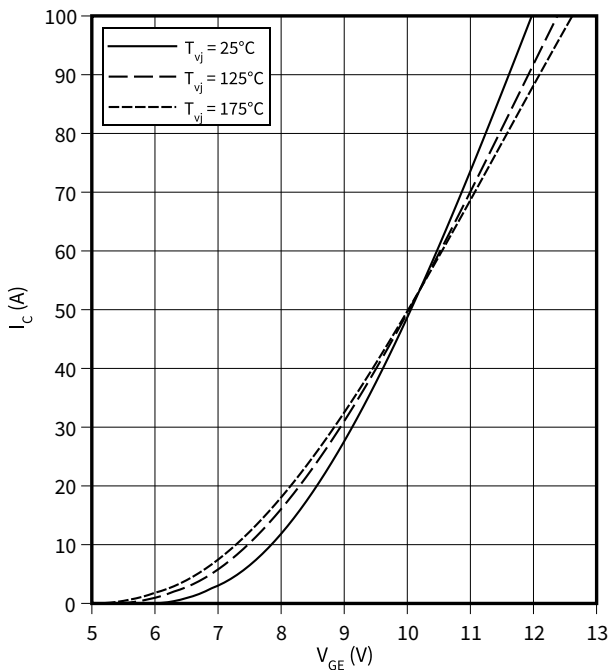

**switching losses (typical), IGBT, Inverter**

$$E = f(I_C)$$

$$R_{Goff} = 7.5 \text{ } \Omega, R_{Gon} = 7.5 \text{ } \Omega, V_{CE} = 600 \text{ V}, V_{GE} = \pm 15 \text{ V}$$

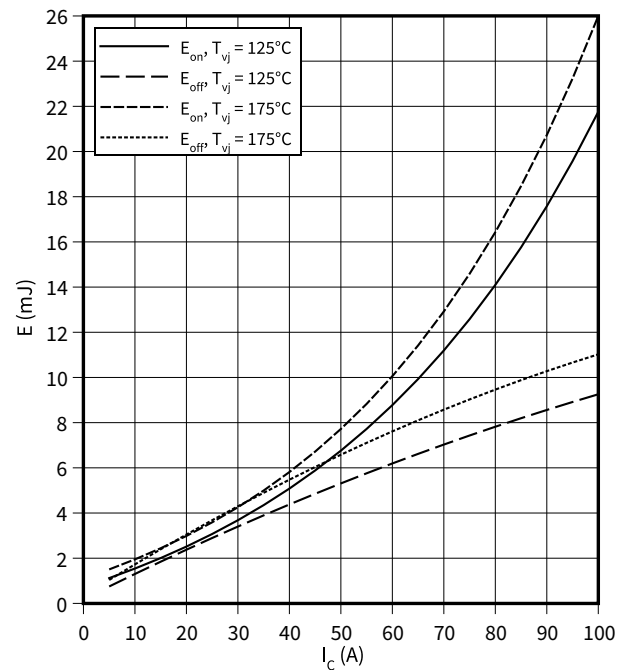

8 Characteristics diagrams

**switching losses (typical), IGBT, Inverter**

$E = f(R_G)$

$I_C = 50 \text{ A}, V_{CE} = 600 \text{ V}, V_{GE} = \pm 15 \text{ V}$

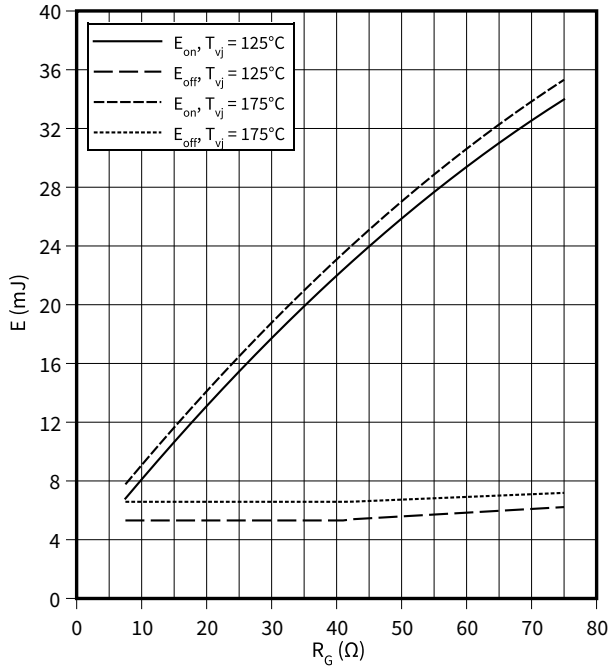

**switching times (typical), IGBT, Inverter**

$t = f(I_C)$

$R_{Goff} = 7.5 \Omega, R_{Gon} = 7.5 \Omega, V_{CE} = 600 \text{ V}, V_{GE} = \pm 15 \text{ V}, T_{vj} = 175 \text{ °C}$

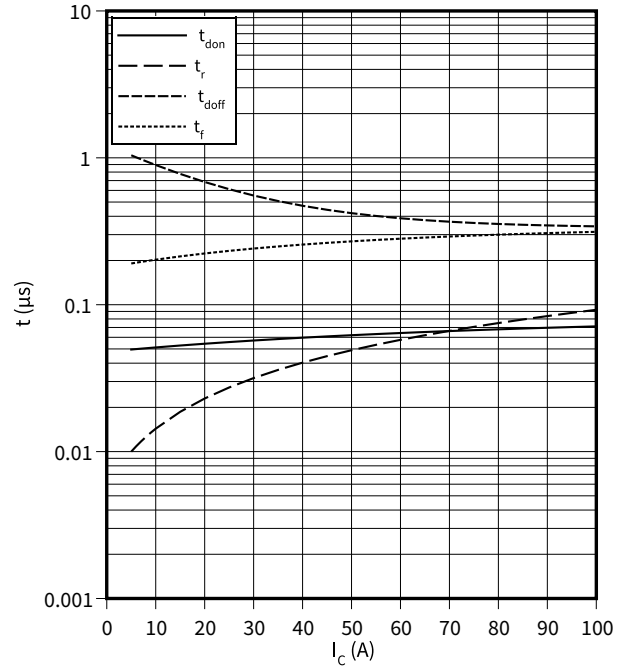

**switching times (typical), IGBT, Inverter**

$t = f(R_G)$

$I_C = 50 \text{ A}, V_{CE} = 600 \text{ V}, V_{GE} = \pm 15 \text{ V}, T_{vj} = 175 \text{ °C}$

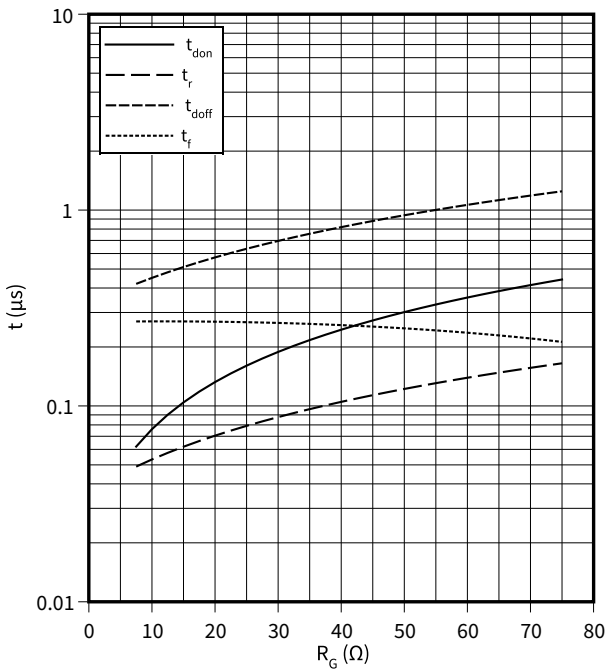

**transient thermal impedance , IGBT, Inverter**

$Z_{th} = f(t)$

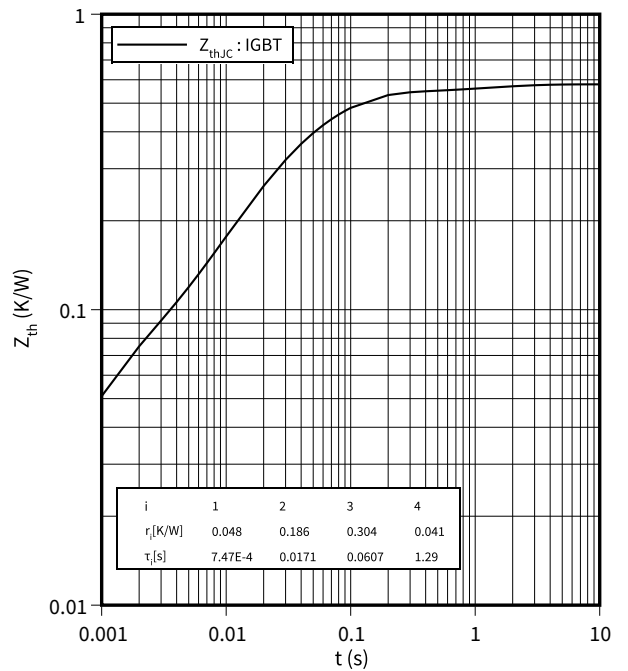

8 Characteristics diagrams

**reverse bias safe operating area (RBSOA), IGBT, Inverter**

$I_C = f(V_{CE})$

$R_{Goff} = 7.5 \Omega, V_{GE} = \pm 15 V, T_{vj} = 175 \text{ }^\circ\text{C}$

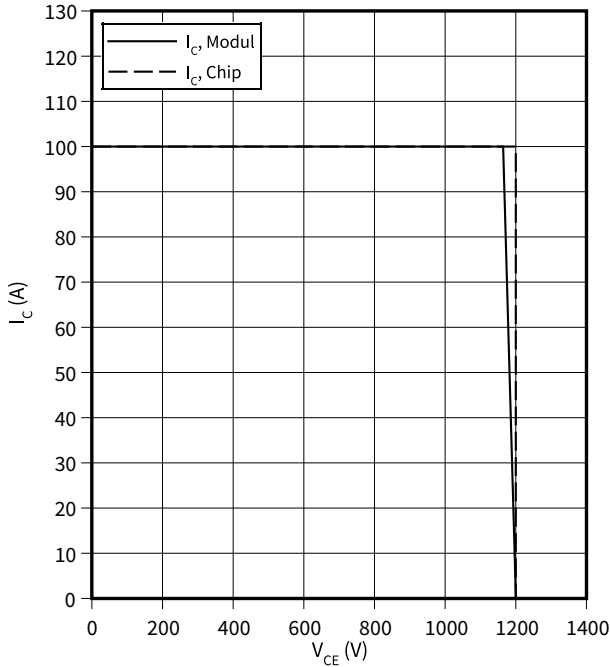

**dv/dt (typical), IGBT, Inverter**

$dv/dt = f(R_G)$

$I_C = 50 A, V_{CE} = 600 V, V_{GE} = \pm 15 V, T_{vj} = 25 \text{ }^\circ\text{C}$

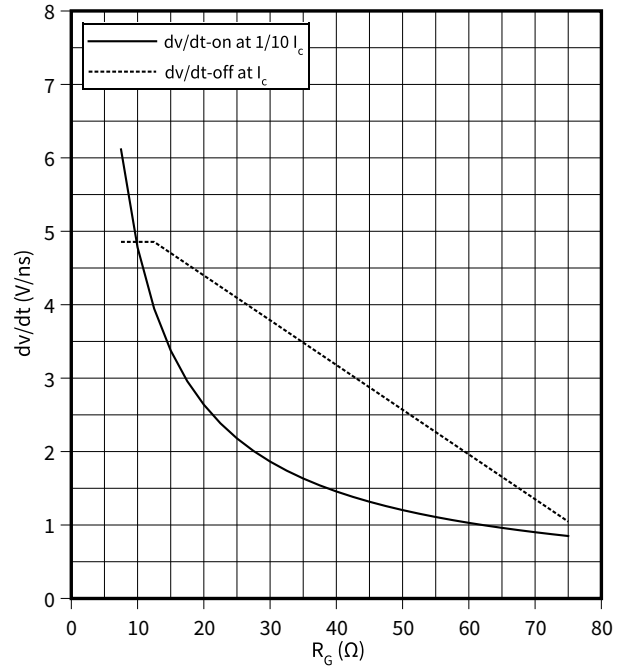

**capacity characteristic (typical), IGBT, Inverter**

$C = f(V_{CE})$

$f = 100 \text{ kHz}, V_{GE} = 0 V, T_{vj} = 25 \text{ }^\circ\text{C}$

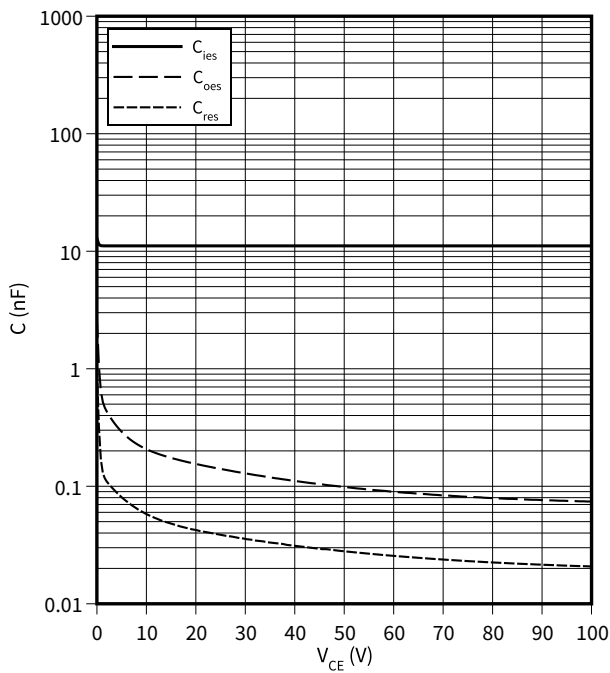

**gate charge characteristic (typical), IGBT, Inverter**

$V_{GE} = f(Q_G)$

$I_C = 50 A, T_{vj} = 25 \text{ }^\circ\text{C}$

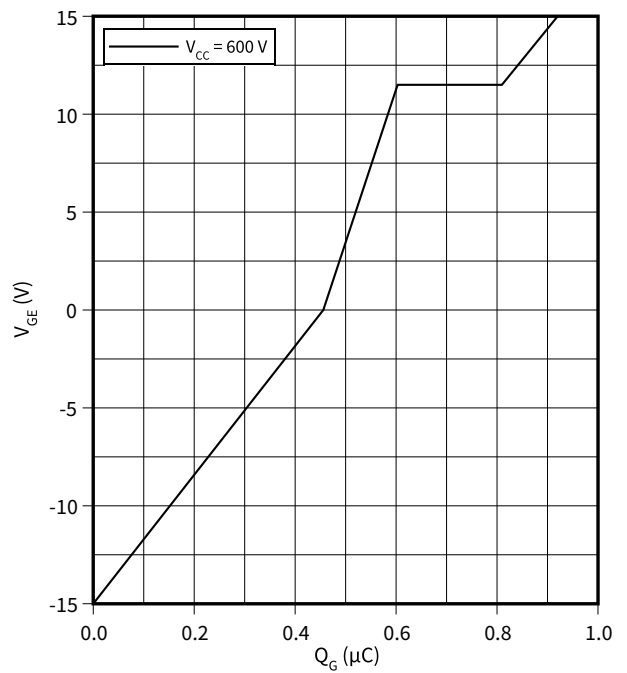

8 Characteristics diagrams

**forward characteristic (typical), Diode, Inverter**

$I_F = f(V_F)$

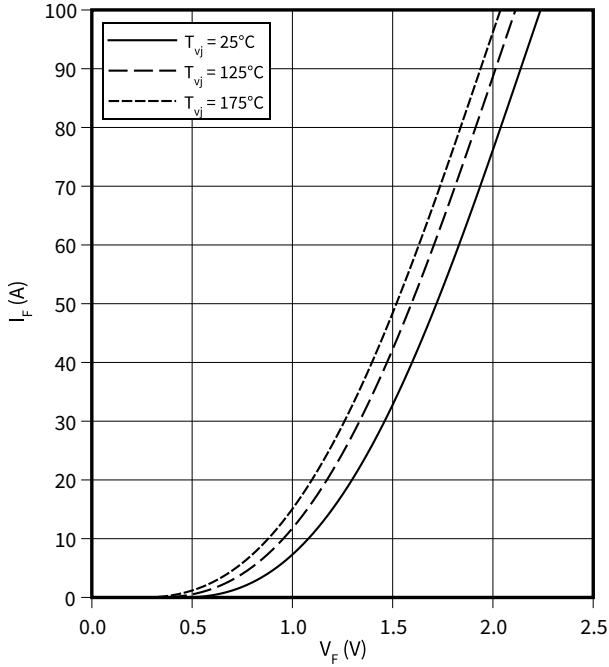

**switching losses (typical), Diode, Inverter**

$E_{rec} = f(I_F)$

$R_{Gon} = 7.5 \Omega, V_{CE} = 600 V$

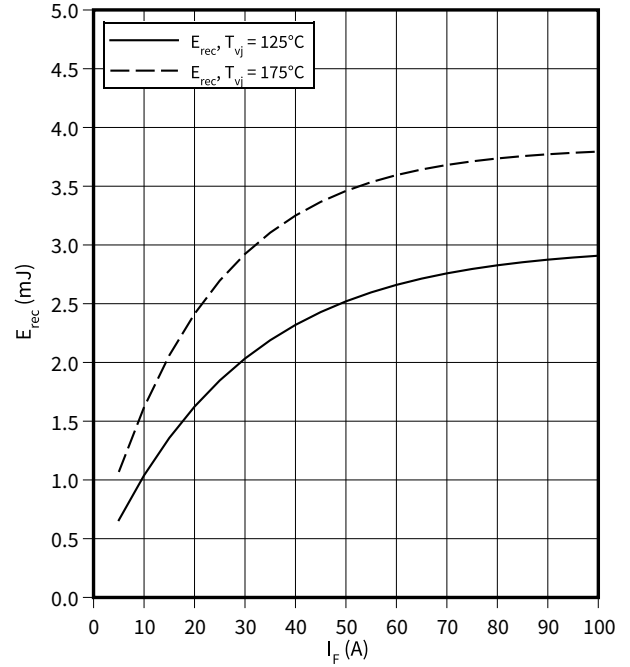

**switching losses (typical), Diode, Inverter**

$E_{rec} = f(R_G)$

$V_{CE} = 600 V, I_F = 50 A$

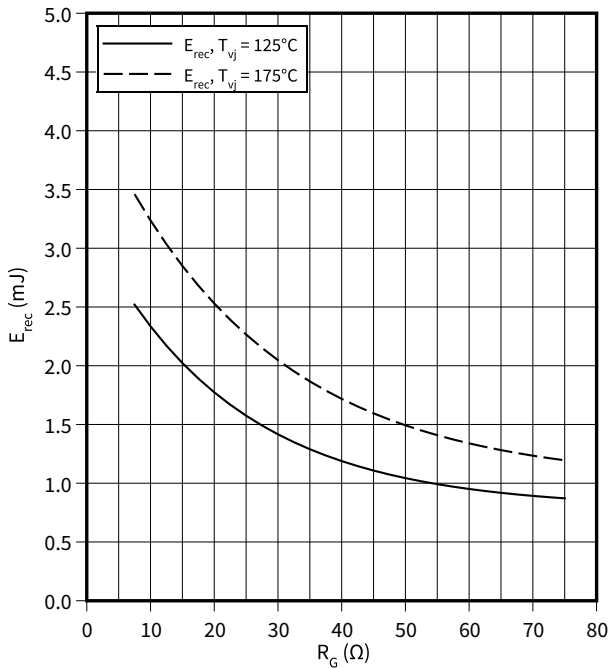

**transient thermal impedance, Diode, Inverter**

$Z_{th} = f(t)$

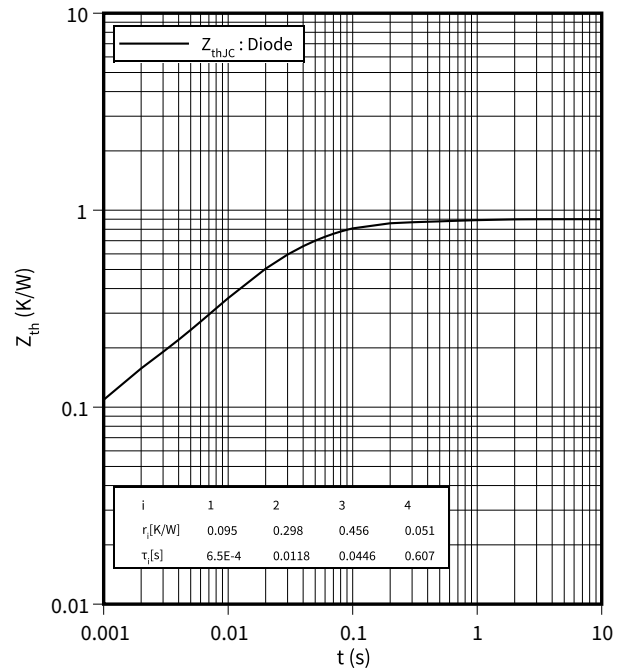

8 Characteristics diagrams

**forward characteristic (typical), Diode, Rectifier**

$I_F = f(V_F)$

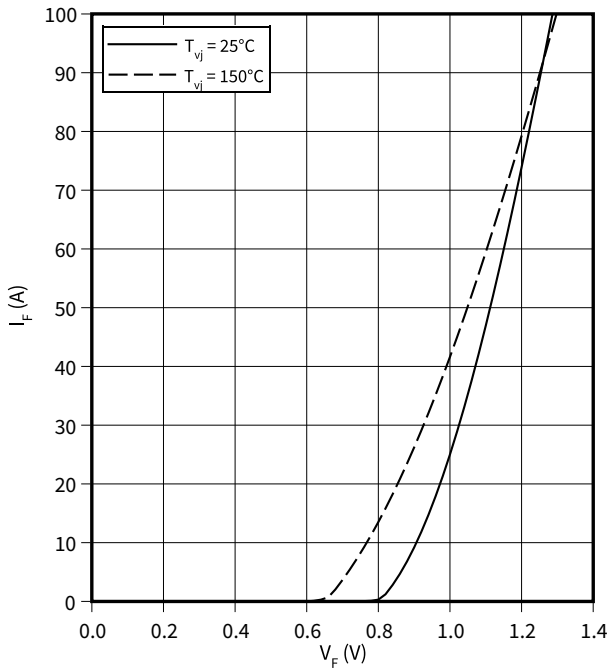

**transient thermal impedance, Diode, Rectifier**

$Z_{th} = f(t)$

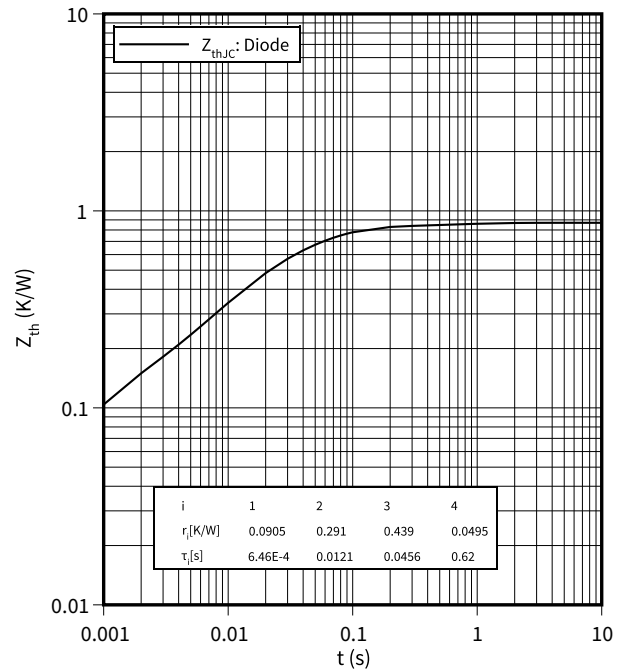

**output characteristic (typical), IGBT-Chopper**

$I_C = f(V_{CE})$

$V_{GE} = 15 \text{ V}$

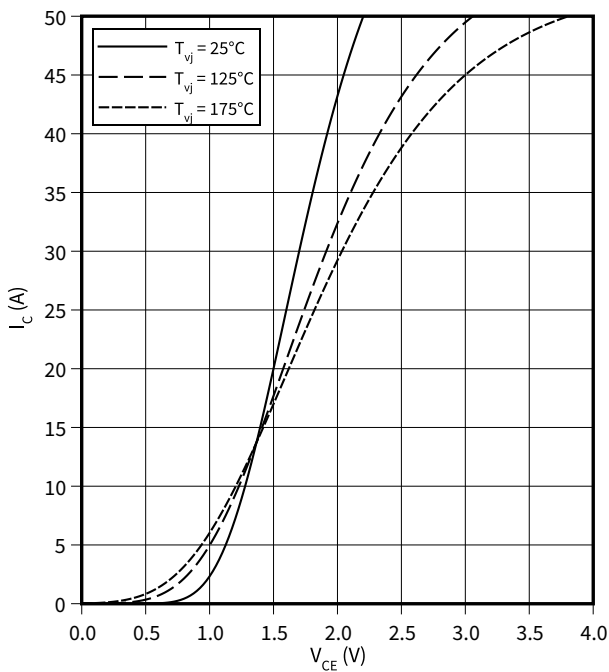

**forward characteristic (typical), Diode, Chopper**

$I_F = f(V_F)$

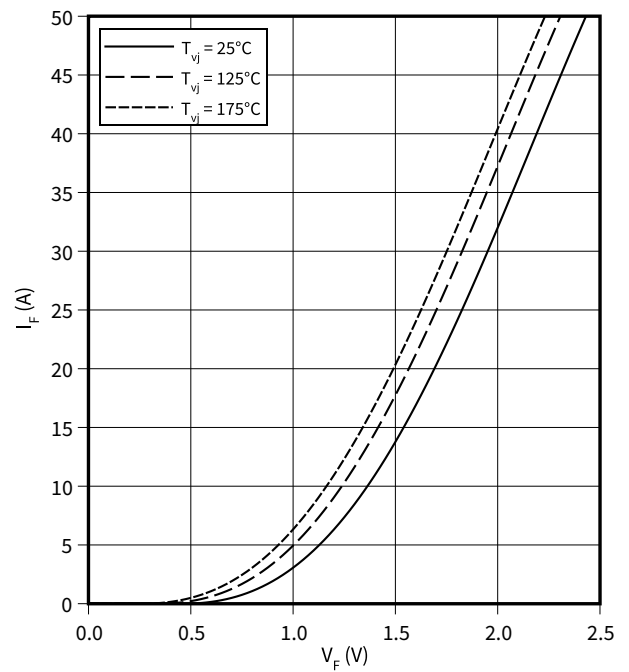

**temperature characteristic (typical), NTC-Thermistor**

$R = f(T_{NTC})$

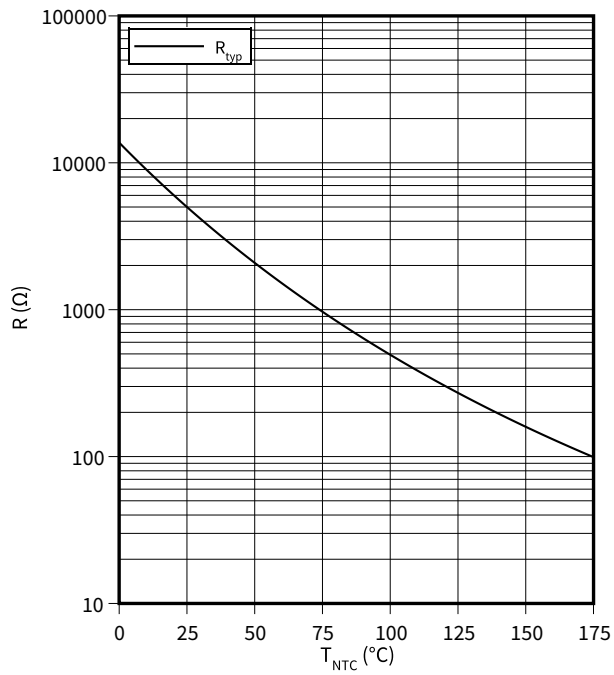



## 9 Circuit diagram

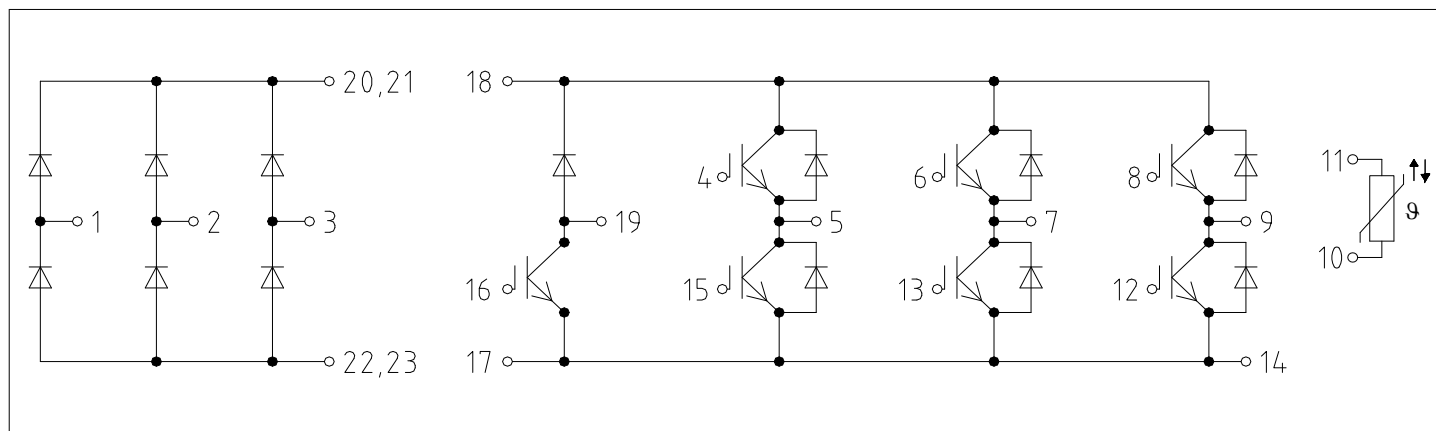

Figure 2

10 Package outlines

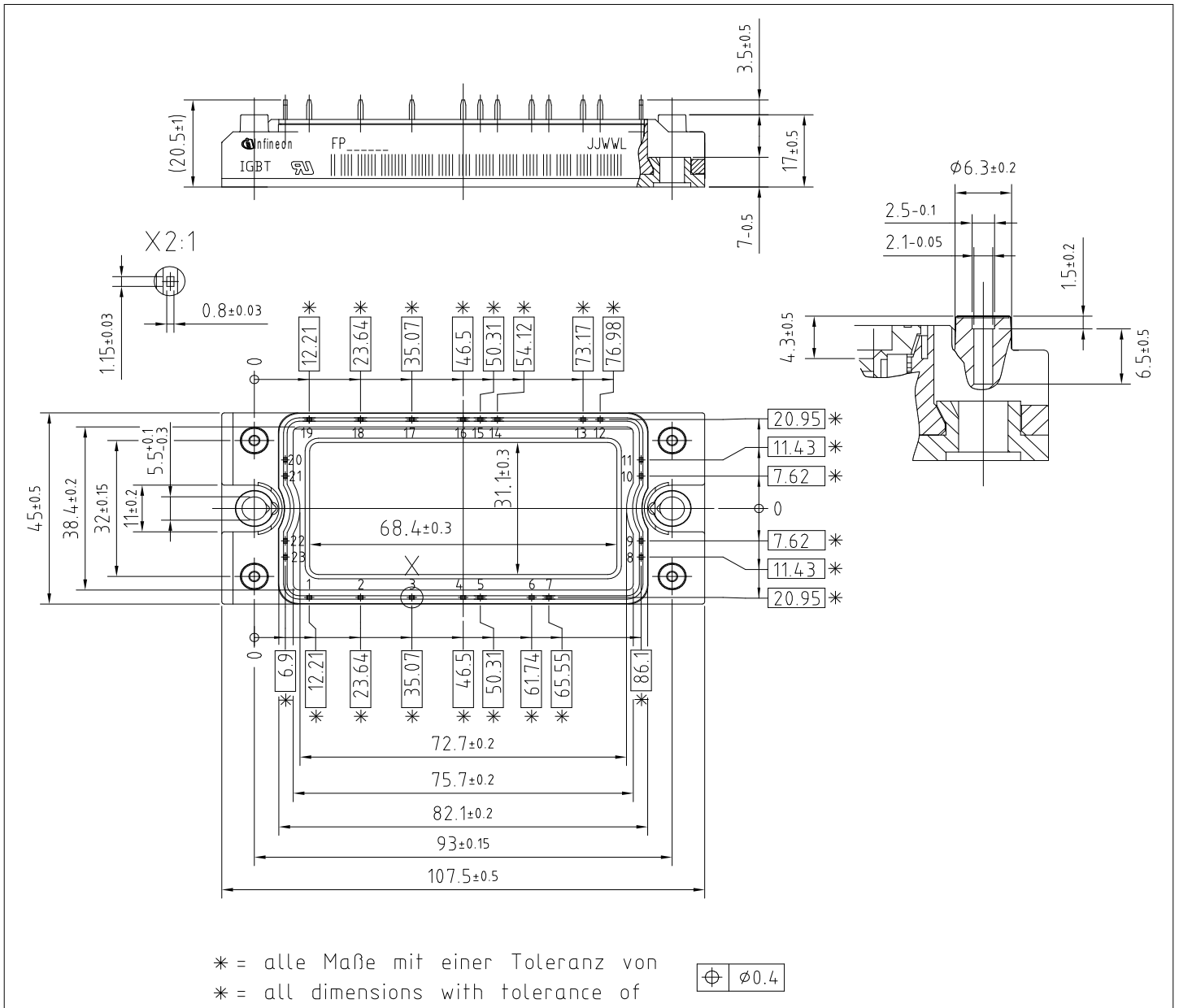



Figure 3

## 11 Module label code

Module label code			
Code format	Data Matrix	Barcode Code128	
Encoding	ASCII text	Code Set A	
Symbol size	16x16	23 digits	
Standard	IEC24720 and IEC16022	IEC8859-1	
Code content	<i>Content</i>	<i>Digit</i>	<i>Example</i>
	Module serial number	1 - 5	71549
	Module material number	6 - 11	142846
	Production order number	12 - 19	55054991
	Date code (production year)	20 - 21	15
	Date code (production week)	22 - 23	30
Example	 		
	71549142846550549911530		71549142846550549911530

**Figure 4**

---

Revision history

## Revision history

Document revision	Date of release	Description of changes
V1.0	2021-06-17	
0.20	2021-06-17	
0.30	2021-06-17	Preliminary datasheet

## Trademarks

All referenced product or service names and trademarks are the property of their respective owners.

**Edition 2021-06-17**

**Published by**

**Infineon Technologies AG**

**81726 Munich, Germany**

**© 2021 Infineon Technologies AG**

**All Rights Reserved.**

**Do you have a question about any aspect of this document?**

**Email: [erratum@infineon.com](mailto:erratum@infineon.com)**

**Document reference**

**IFX-AAAY119-003**

## IMPORTANT NOTICE

The information given in this document shall in no event be regarded as a guarantee of conditions or characteristics ("Beschaffheitsgarantie").

With respect to any examples, hints or any typical values stated herein and/or any information regarding the application of the product, Infineon Technologies hereby disclaims any and all warranties and liabilities of any kind, including without limitation warranties of non-infringement of intellectual property rights of any third party.

In addition, any information given in this document is subject to customer's compliance with its obligations stated in this document and any applicable legal requirements, norms and standards concerning customer's products and any use of the product of Infineon Technologies in customer's applications.

The data contained in this document is exclusively intended for technically trained staff. It is the responsibility of customer's technical departments to evaluate the suitability of the product for the intended application and the completeness of the product information given in this document with respect to such application.

Please note that this product is not qualified according to the AEC Q100 or AEC Q101 documents of the Automotive Electronics Council.

## WARNINGS

Due to technical requirements products may contain dangerous substances. For information on the types in question please contact your nearest Infineon Technologies office.

Except as otherwise explicitly approved by Infineon Technologies in a written document signed by authorized representatives of Infineon Technologies, Infineon Technologies' products may not be used in any applications where a failure of the product or any consequences of the use thereof can reasonably be expected to result in personal injury.