

SLF12565T-101M1R6-PF

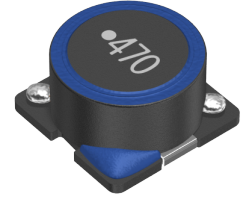

Applications	Commercial Grade
Feature	Wire Wound Wire Wound Shield Magnetic Shield Ferrite Core Ferrite Core
Series Type	SLF
Status	Production (Not Recommended for New Design) Recommended Alternate Part No. : CLF12555T-101M-D (Interchangeability is not guaranteed.)
Brand	TDK



Size	
Length(L)	12.50mm ±0.30mm
Width(W)	12.50mm ±0.30mm
Thickness Height	6.50mm ±0.35mm
Recommended Land Pattern (A)	2.60mm Nom.
Recommended Land Pattern (B)	8.50mm Nom.
Recommended Land Pattern (C)	3.20mm Nom.

Electrical Characteristics	
Inductance	100µH ±20% at 1kHz
Rated Current (L Change) [Typ.]	
Rated Current (L Change) [Max.]	1.6A (10% Down)
Rated Current (Temperature Rise) [Typ.]	1.9A (40°C Rise)
Rated Current (Temperature Rise) [Max.]	
DC Resistance [Typ.]	123mΩ
DC Resistance [Max.]	148mΩ
Rated Voltage [Max.]	
Self Resonant Frequency [Min.]	
Self Resonant Frequency [Typ.]	
Q [Min.]	
Q [Typ.]	

Other	
Operating Temp. Range (Including Self-Temp. Rise)	-40 to 105°C
Soldering Method	Reflow Iron Soldering
AEC-Q200	NO
Packing	Embossed (Plastic)Taping [330mm Reel]

! Images are for reference only and show exemplary products.
 ! This PDF document was created based on the data listed on the TDK Corporation website.
 ! All specifications are subject to change without notice.

SLF12565T-101M1R6-PF



Package Quantity	500pcs
------------------	--------

Weight	3.2g
--------	------

SLF12565T-101M1R6-PF



Characteristic Graphs(This is reference data, and does not guarantee the products characteristics.)

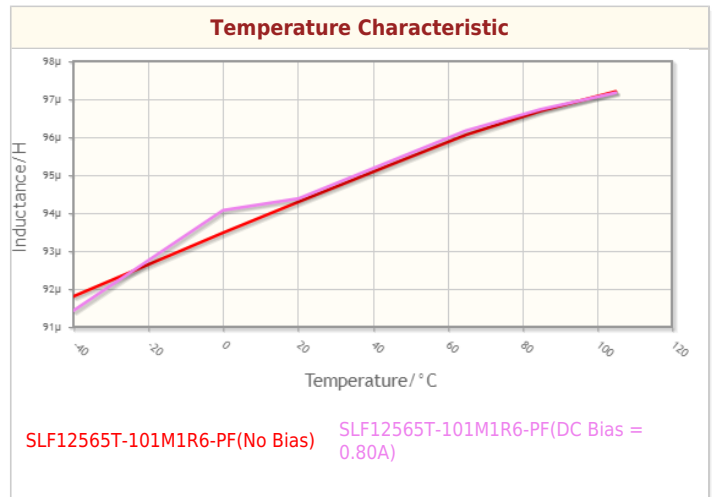
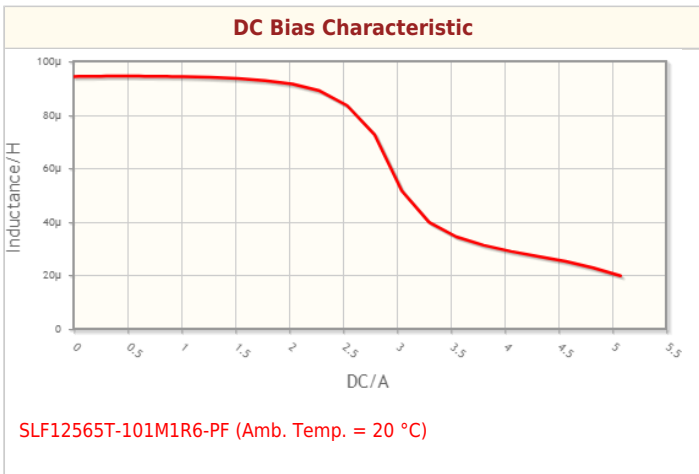
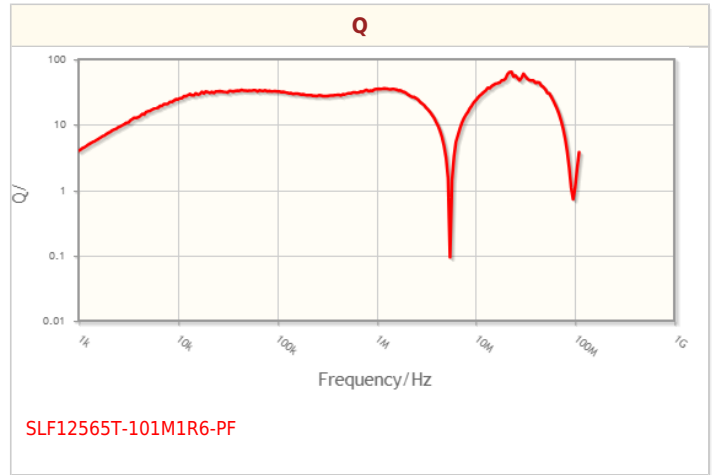
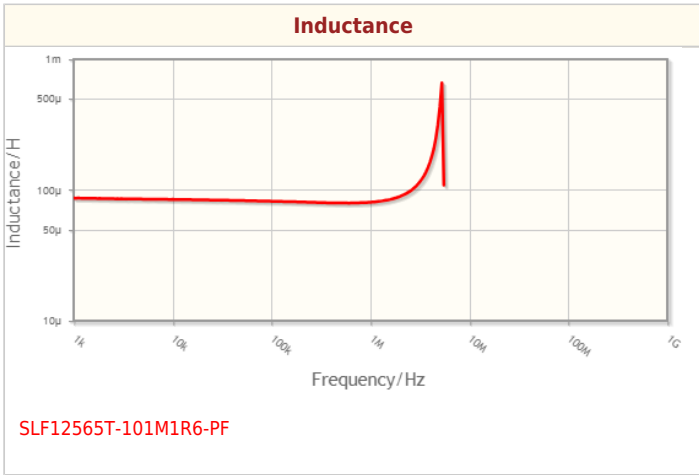
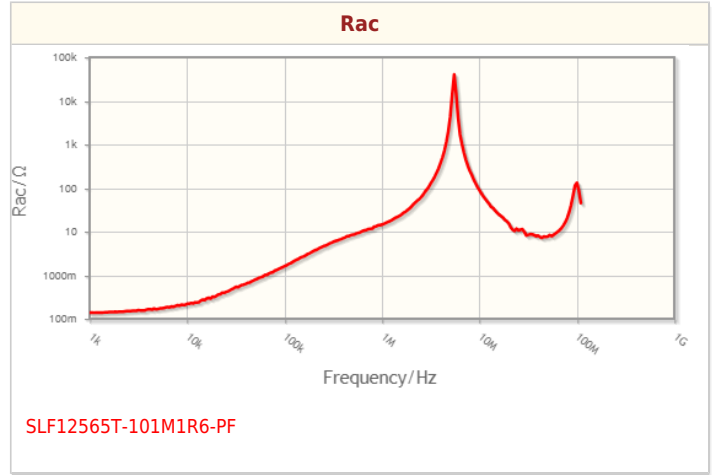
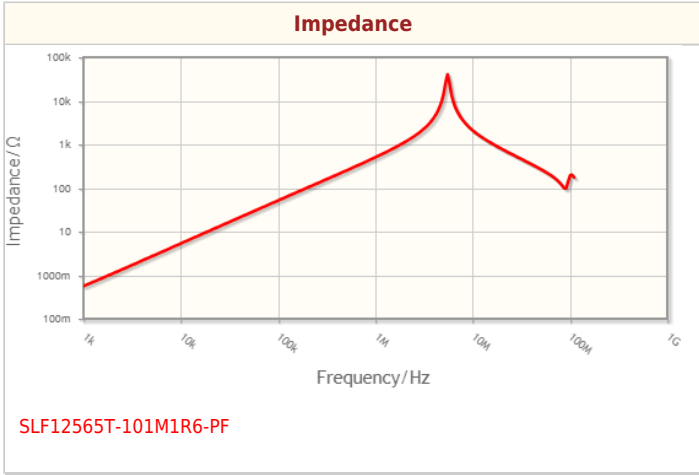

! Images are for reference only and show exemplary products.
! This PDF document was created based on the data listed on the TDK Corporation website.
! All specifications are subject to change without notice.

SLF12565T-101M1R6-PF



Characteristic Graphs(This is reference data, and does not guarantee the products characteristics.)

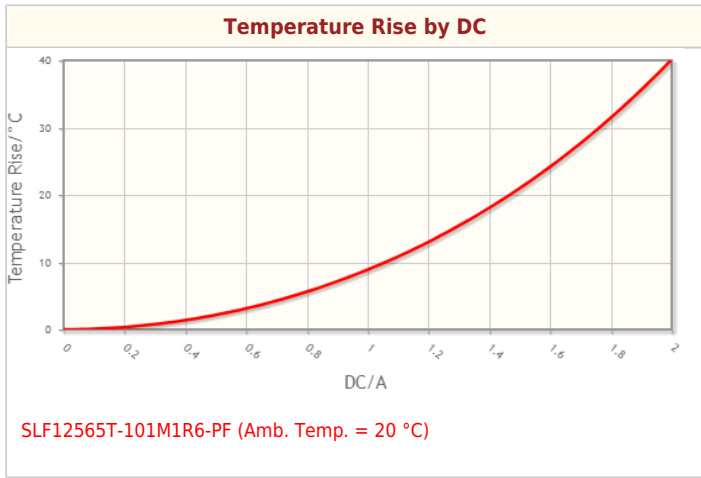

! Images are for reference only and show exemplary products.
! This PDF document was created based on the data listed on the TDK Corporation website.
! All specifications are subject to change without notice.

SLF12565T-101M1R6-PF



Associated Images

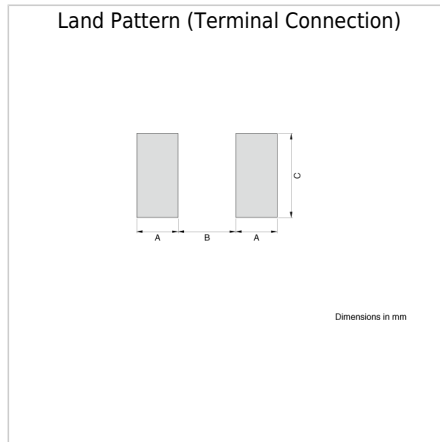
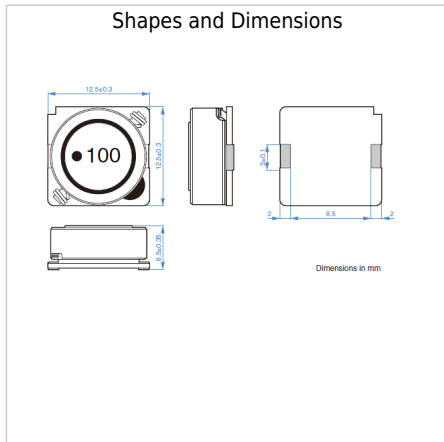

! Images are for reference only and show exemplary products.
! This PDF document was created based on the data listed on the TDK Corporation website.
! All specifications are subject to change without notice.