

Compact Guide Cylinder

Series MGP

ø12, ø16, ø20, ø25, ø32, ø40, ø50, ø63, ø80, ø100



- MGJ
- MGP**
- MGQ
- MGG
- MGC
- MGF
- MGZ
- MGT

Series Variations

Series	Bearing type	Cushion	Bore size (mm)										Page			
			12	16	20	25	32	40	50	63	80	100				
Standard type MGP	Slide bearing Ball bushing bearing	Rubber bumper	●	●	●	●	●	●	●	●	●	●	●	●	<ul style="list-style-type: none"> • Clean series: ø12 to ø63 • Water resistant: ø20 to ø100 (Note) • Copper/Fluorine-free: ø12 to ø100 	P. 269
With air cushion MGP		Air cushion	●	●	●	●	●	●	●	●	●	●	●	●		<ul style="list-style-type: none"> • Copper/Fluorine-free (20-)
With end lock MGP	Slide bearing	Rubber bumper			●	●	●	●	●	●	●	●	●	●	(Note) Available with ø20 to ø100 slide bearing type only	P. 307
Heavy duty guide rod type MGPS		Rubber bumper							●					●		P. 319
High precision ball bushing bearing type MGPA	Ball bushing bearing	Rubber bumper/ Air cushion	●	●	●	●	●	●	●	●	●	●	●	●	P. 329	

- D-
- X
- Individual
-X

Combinations of Standard Products and Made

Series *MGP*

● : Standard ◎ : Made to Order specifications ○ : Special product (Contact SMC for details.) — : Not available

Bearing		Basic type		Air cushion	
		Slide bearing	Ball bushing	Slide bearing	Ball bushing
Type		MGPM	MGPL	MGPM	MGPL
Bore size		ø12 to 100		ø16 to 100	
Basic type		●	●	—	—
With air cushion		—	—	●	●
With end lock		—	—	○	○
12-	Clean series ^{Note 1)}	—	●	—	○
13-	Clean series ^{Note 1)}	—	●	—	○
20-	Copper-free	●	●	●	●
21-	Copper-free/Clean series ^{Note 1)}	—	●	—	○
R/V	Water resistant ^{Note 2)}	●	—	○	—
XB6	Heat resistant cylinder (–10 to 150°C) ^{Note 3)}	◎	—	○	—
XB9	Low speed cylinder (10 to 50 mm/s)	○	○	○	○
XB10	Intermediate stroke (Exclusive body)	◎	◎	○	○
XB13	Low speed cylinder (5 to 50 mm/s)	◎	◎	○	○
XC4□	With heavy duty scraper ^{Note 4)}	◎	◎	○	○
XC6□	Made of stainless steel	◎	◎	○	○
XC8	Adjustable stroke cylinder/Adjustable extension type	◎	◎	—	—
XC9	Adjustable stroke cylinder/Adjustable retraction type	◎	◎	—	—
XC19	Intermediate stroke (Spacer type)	—	—	◎	◎
XC22	Fluororubber seals ^{Note 5)}	◎	—	○	—
XC35□	With coil scraper ^{Note 4)}	◎	◎	○	○
XC69	With shock absorber	◎	◎	—	—
XC79	Machining tapped hole, drilled hole and pin hole additionally	◎	◎	◎	◎
XC82	Bottom mounting style	◎	—	○	—
X144	Symmetrical port position	◎	◎	○	○
X867	Lateral piping type (Change of plug position)	◎	◎	◎	◎

Note 1) MGPL: 12 to 63 only

Note 2) MGPL: 20 to 100 only

Note 3) Without cushion, MGPL: (—). (○): With auto switch

Note 4) For ø20 to ø100 only

Note 5) Without cushion, MGPL: (—).

to Order Specifications

Series **MGP**

	With end lock		Heavy duty guide type	High precision ball bushing type		
	Slide bearing	Ball bushing	Slide bearing	Basic type	Air cushion	With end lock
	MGPM	MGPL	MGPS	MGPA	MGPA	MGPA
	ø20 to 100		ø50, ø80	ø12 to 100	ø16 to 100	ø20 to 100
	—	—	●	●	—	—
	○	○	○	—	●	○
	●	●	○	—	○	●
	—	○	—	—	—	—
	—	○	—	—	—	—
	○	○	○	—	○	○
	—	○	—	—	—	—
	○	—	○	—	—	—
	○	—	○	—	—	—
	○	○	○	○	○	○
	○	○	○	◎	◎	○
	○	○	○	○	○	○
	○	○	○	◎	○	○
	○	○	○	—	—	—
	—	—	○	◎	—	—
	—	—	○	◎	—	—
	—	—	—	—	◎	—
	○	—	○	—	—	—
	○	○	○	◎	○	○
	—	—	○	◎	—	—
	◎	◎	○	◎	◎	◎
	○	—	○	—	—	—
	○	○	○	◎	○	○
	◎	◎	◎	◎	◎	◎

- MGJ
- MGP**
- MGQ
- MGG
- MGC
- MGF
- MGZ
- MGT

- D-□
- X□
- Individual
-X□

● With end lock type

- Holds the cylinder's home position even if the air supply is cut off.
- Compact body $\varnothing 20$ to $\varnothing 63$ Standard + 25 mm body length
 $\varnothing 80, \varnothing 100$ Standard + 50 mm body length

■ Stroke Variations

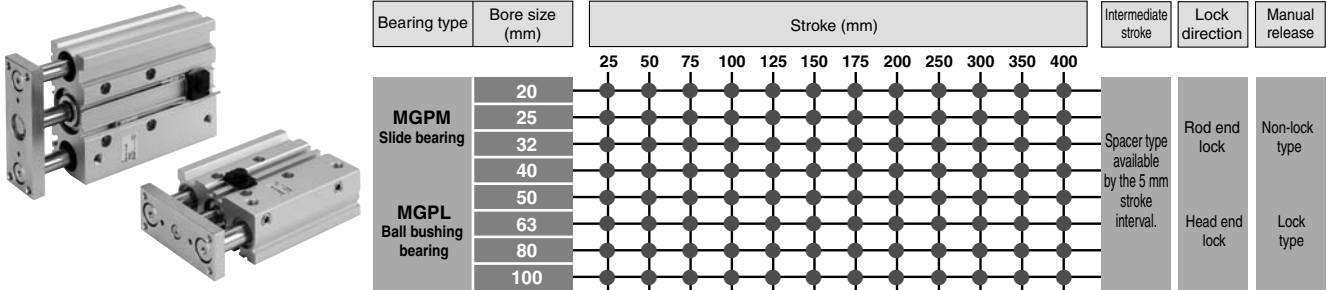

● With air cushion type

- An air cushion has been added to the compact guide cylinder to suppress vibration and noise at the stroke end. It can absorb nearly three times as much kinetic energy as a rubber bumper.

Cushion valve is built into the body

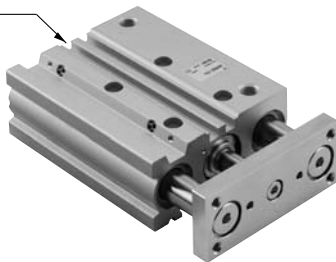

■ Stroke Variations

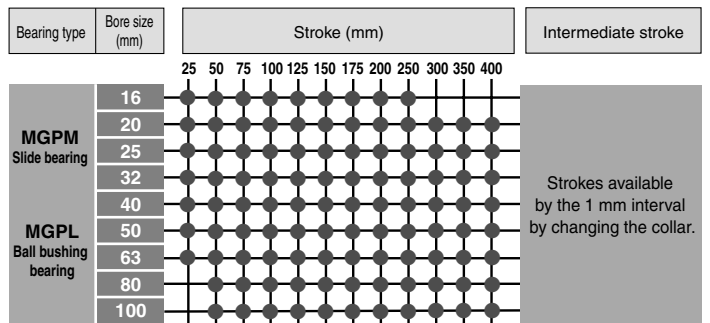

MGJ

MGP

MGQ

MGG

MGC

MGF

MGZ

MGT

● Heavy duty guide rod type with improved load resistance



■ Stroke Variations

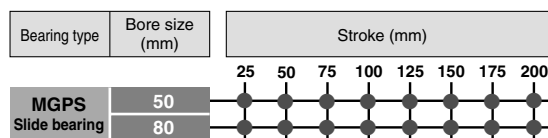

- Anti-lateral load: $\Delta 10\%$ increase
 - Eccentric load resistance: $\Delta 25\%$ increase
 - Impact load resistance: $\Delta 140\%$ increase
- (Compared with MGPM50 compact guide cylinder)

Bore size (mm)	Guide rod diameter (mm)	
	MGPS	MGPM
50	30	25
80	45	30

D-□

-X□

Individual
-X□

Full Made to Order Variation

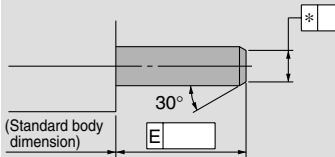
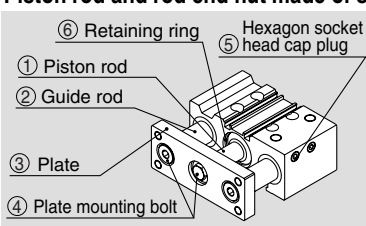
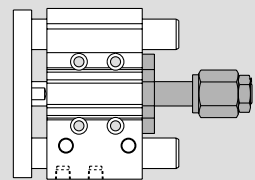
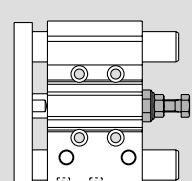
Description	
Heat resistant cylinder (-10 to 150°C) Symbol -XB6 An air cylinder with special seal material and grease, so that it can be used even at an ambient temperature range from -10°C up to 150°C. (MGPM only)	
Intermediate stroke (Using exclusive body) Symbol -XB10 When intermediate strokes other than standard strokes are used, this cylinder could shorten the full length and reduce the mounting space with an exclusive body without a spacer.	
Low speed cylinder (5 to 50mm/s) Symbol -XB13 Smooth operation is possible with minimal sticking and slipping at low speeds of 5 to 50 mm.	
With heavy duty scraper Symbol -XC4 A cylinder with a heavy duty scraper is used for the wiper ring is suitable for use in an environment where there is a lot of dust in the surrounding area or where the equipment is exposed to earth and sand (die-casting equipment, construction machinery, industrial vehicles, etc.).	
Change of guide rod end shape Symbol -XA1,6,17,21  <p>Some patterns of guide rod end shape. 4 diagrams are available. Specify dimensions on a drawing and order the desired product.</p>	
Piston rod and rod end nut made of stainless steel Symbol -XC6  <p>These are suitable for cases where rust or corrosion due to being immersed in water are likely. Use stainless steel for parts ① to ⑥.</p>	
Adjustable stroke cylinder/Adjustable extension type Symbol -XC8  <p>Install a stroke adjusting unit on the head side to adjust strokes at the outlet. (After adjusting stroke, both-side cushion style is changed into single side cushion style.)</p>	
Adjustable stroke cylinder/Adjustable retraction type Symbol -XC9  <p>The retract stroke of the cylinder can be adjusted with the adjusting bolt.</p>	
Intermediate stroke (Spacer type) Symbol -XC19 When intermediate strokes other than standard strokes are used, this cylinder could shorten the full length and reduce the mounting space with a spacer.	
Fluororubber seals Symbol -XC22 Fluororubber is used for seals.	

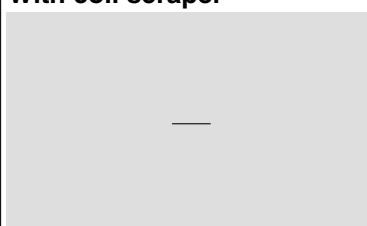
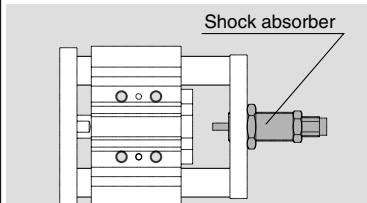
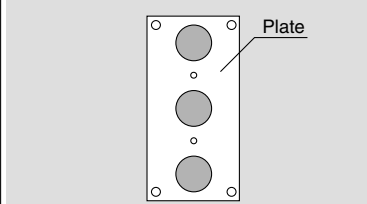
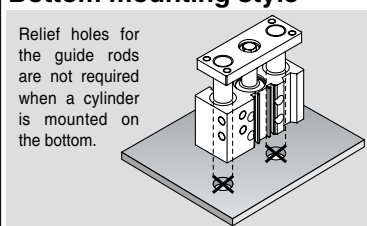
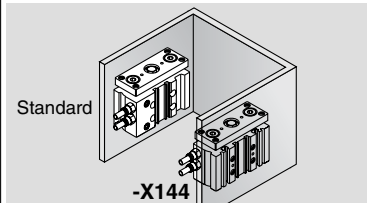
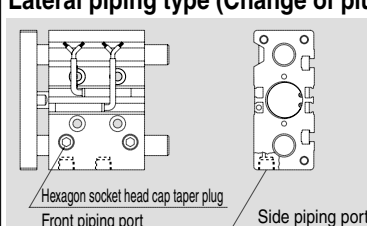
Description	
With coil scraper Symbol -XC35  <p>It gets rid of frost, ice, weld spatter, cutting chips adhered to the piston rod, and protects the seals, etc.</p>	
With shock absorber Symbol -XC69  <p>A shock absorber reduces the impact on the stroke extended side end.</p>	
Machining tapped hole, drilled hole and pin hole additionally Symbol -XC79  <p>Tapped, drilled and pin holes are additionally machined to install a workpiece to the plate.</p>	
Bottom mounting style Symbol -XC82  <p>Relief holes for the guide rods are not required when a cylinder is mounted on the bottom. The guide rod does not protrude from the bottom when the rod is retracting.</p>	
Symmetrical port position Symbol -X144  <p>This makes it easy to remove and rotate piping when it is mounted on a wall where mounting space is limited.</p>	
Lateral piping type (Change of plug position) Symbol -X867  <p>A type which plugs the piping port on the top in order to use it on the side.</p>	

Compact Guide Cylinder

Series *MGP*

∅12, ∅16, ∅20, ∅25, ∅32, ∅40, ∅50, ∅63, ∅80, ∅100



- MGJ
- MGP**
- MGQ
- MGG
- MGK
- MGF
- MGZ
- MGT

Stroke Variations

Bearing type	Bore size (mm)	Stroke (mm)																	Intermediate stroke
		10	20	25	30	40	50	75	100	125	150	175	200	250	300	350	400		
MGPM Slide bearing	12	●	●		●	●	●	●	●	●	●	●	●	●	●	●	●	●	Spacer installation type Available by the 1 mm & 5 mm interval. Exclusive body (-XB10) in stroke increments of 1 mm
	16	●	●		●	●	●	●	●	●	●	●	●	●	●	●	●	●	
	20	●	●		●	●	●	●	●	●	●	●	●	●	●	●	●	●	
	25	●	●	●	●	●	●	●	●	●	●	●	●	●	●	●	●	●	
	32			●	●	●	●	●	●	●	●	●	●	●	●	●	●	●	
MGPL Ball bushing bearing	40			●	●	●	●	●	●	●	●	●	●	●	●	●	●	●	
	50			●	●	●	●	●	●	●	●	●	●	●	●	●	●	●	
	63			●	●	●	●	●	●	●	●	●	●	●	●	●	●	●	
	80			●	●	●	●	●	●	●	●	●	●	●	●	●	●	●	
	100			●	●	●	●	●	●	●	●	●	●	●	●	●	●	●	

- D-
- X
- Individual
-X



Series MGP Specific Product Precautions 1

Be sure to read before handling.

Refer to front matters 42 and 43 for Safety Instructions and pages 3 to 11 for Actuator and Auto Switch Precautions.

Mounting

Warning

1. Never place your hands or fingers between the plate and the body.

Be very careful to prevent your hands or fingers from getting caught in the gap between the cylinder body and the plate when air is applied.

Caution

1. Use cylinders within the piston speed range.

An orifice is set for this cylinder, but the piston speed may exceed the operating range if the speed controller is not used. If the cylinder is used outside the operating speed range, it may cause damage to the cylinder and shorten the service life. Adjust the speed by installing the speed controller and use the cylinder within the limited range.

2. Do not scratch or gouge the sliding portion of the piston rod and the guide rod.

Damaged seals, etc. will result in leakage or malfunction.

3. Do not dent or scratch the mounting surface of a body and a plate.

The flatness of the mounting surface may not be maintained, which would cause an increase in sliding resistance.

4. Make sure that the cylinder mounting surface has a flatness of 0.05 mm or less.

If the flatness of the workpieces and brackets mounted on the plate is not appropriate, sliding resistance may increase.

5. Bottom of cylinder

The guide rods protrude from the bottom of the cylinder at the end of the retracting stroke, and therefore, in cases where the cylinder is to be bottom mounted, it is necessary to provide bypass ports in the mounting surface for the guide rods, as well as holes for the hexagon socket head screws which are used for mounting.

Moreover, in applications where impact occurs from a stopper, etc., the mounting bolts should be inserted to a depth of 2 d or more (1.5 d or more for MGPS).

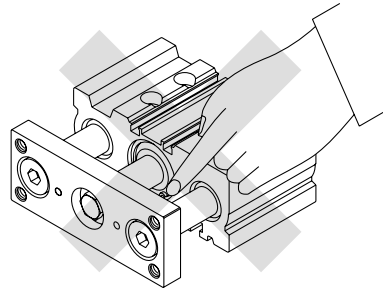

Cushion

With air cushion

Caution

1. Keep the adjusting range of the cushion valve within 3 rotations of the completely closed position.

When adjusting the cushion valve, use the following screwdriver or hexagon wrenches. Keep the adjusting range of the cushion valve within 3 rotations of the completely closed position. Air leakage will occur if operated after opening by 4 rotations or more. Furthermore, a stopper mechanism is provided for the cushion valve, and it should not be forced open beyond that position.

Bore size (mm)	Applicable tool
16	Flat head watchmakers' screwdriver 3 mm
20,25,32,40	JIS B 4648 hexagon wrench key 1.5
50,63	JIS B 4648 hexagon wrench key 2.5
80,100	JIS B 4648 hexagon wrench key 4

2. Be sure to activate the air cushion at the cylinder stroke end.

Be sure to activate the air cushion at the end of the cylinder stroke. When it is intended to operate with the cushion valve fully opened, select a cylinder equipped with rubber bumper. If operated without confirming this point, the piston rod assembly, etc., may be damaged.

3. Be sure to operate a cylinder equipped with air cushion to the end of the stroke.

If it is not operated to the end of the stroke, the effect of the air cushion will not be fully exhibited. Consequently, in cases where the stroke is regulated by an external stopper, etc., caution must be exercised, as the air cushion will become completely ineffective.

Series MGP

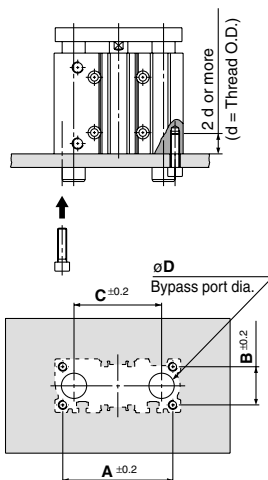

Bore size (mm)	A (mm)	B (mm)	C (mm)	D (mm)		Hexagon socket head cap screw
				MGPM	MGPL	
12	50	18	41	10	8	M4 x 0.7
16	56	22	46	12	10	M5 x 0.8
20	72	24	54	14	12	M5 x 0.8
25	82	30	64	18	15	M6 x 1.0
32	98	34	78	22	18	M8 x 1.25
40	106	40	86	22	18	M8 x 1.25
50	130	46	110	27	22	M10 x 1.5
63	142	58	124	27	22	M10 x 1.5
80	180	54	156	33	28	M12 x 1.75
100	210	62	188	39	33	M14 x 2.0

Series MGPS

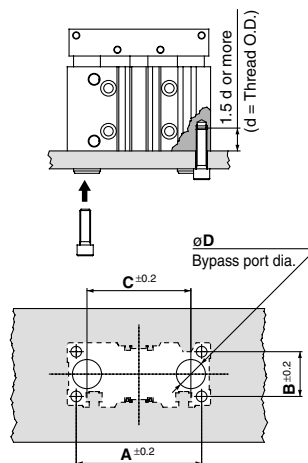

Bore size (mm)	A (mm)	B (mm)	C (mm)	D (mm)	Hexagon socket head cap screw
50	140	50	116	32	M12 x 1.75
80	214	66	170	47	M16 x 2

Piping

Caution

Depending on the operating conditions, piping port positions can be changed by using a plug.

1. For M5

After tightening by hand, tighten additional 1/6 to 1/4 rotation with a tightening tool.

2. For taper thread

Use the correct tightening torques listed below. Before tightening the plug, wrap pipe tape around it. Also, with regard to the sunk dimension of a plug (a dimension in the drawing), use the stipulated figures as a guide and confirm the air leakage before operation.

* If tightening plugs on the top mounting port with more than the proper tightening torque, plugs will be screwed much deeply and air passage will be squeezed. Consequently, the cylinder speed will be restricted.

Connection thread (plug) size	Proper tightening torque (N·m)	a dimension
1/8	7 to 9	0.5 mm or less
1/4	12 to 14	1 mm or less
3/8	22 to 24	1 mm or less

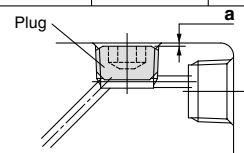



Series MGP Specific Product Precautions 2

Be sure to read before handling.
Refer to front matters 42 and 43 for Safety Instructions and pages 3 to 11 for Actuator and Auto Switch Precautions.

Allowable Kinetic Energy

Load mass and a maximum speed must be within the ranges shown in the graphs below.

MGP with rubber bumper

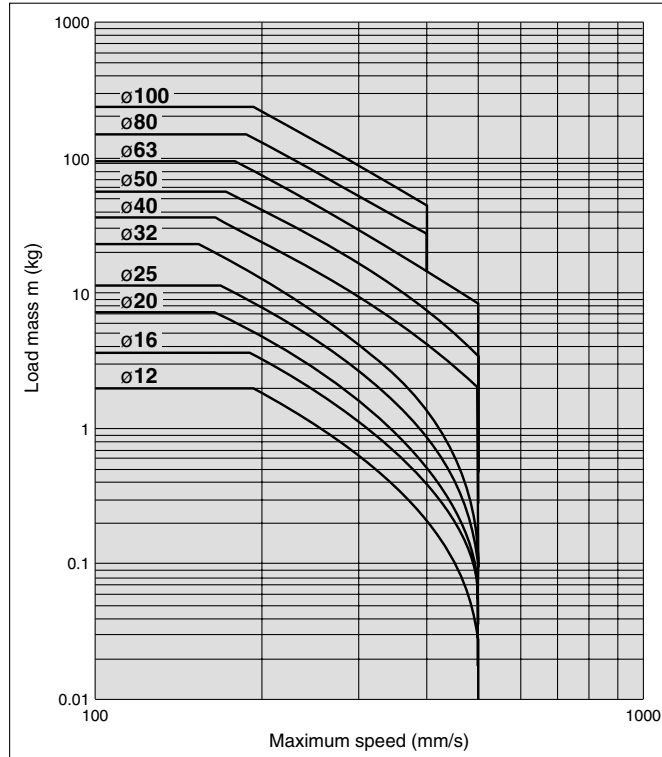

MGP with air cushion

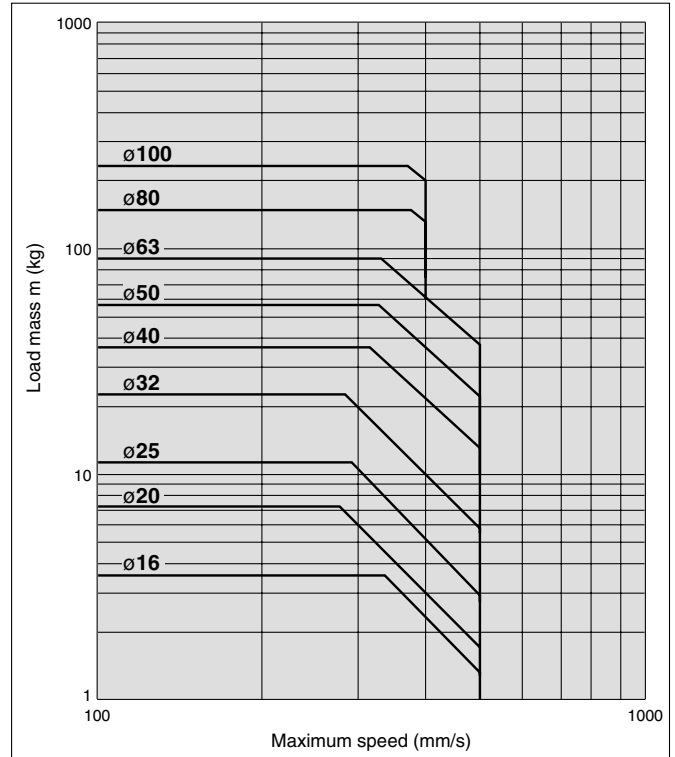

MGP without cushion (MGP-□V (Water resistant), XB6, XC9, XC22)

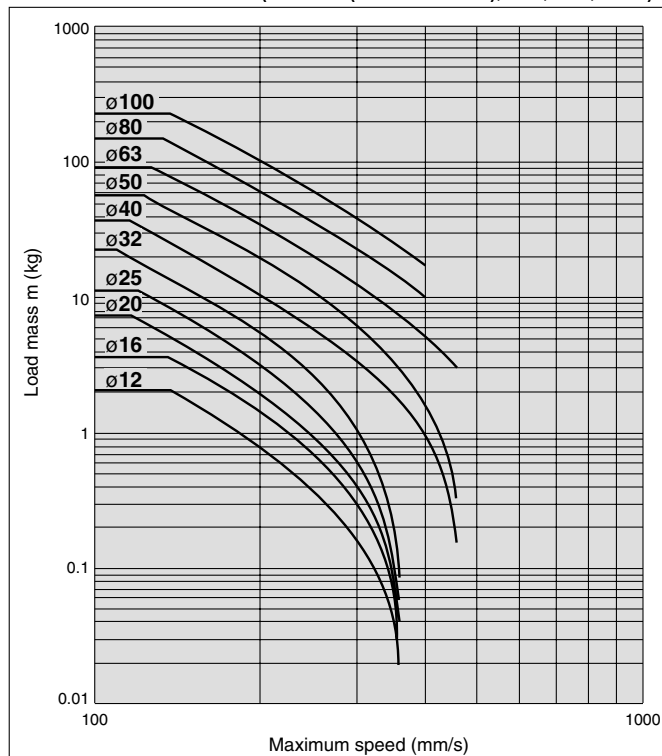

MGJ

MGP

MGQ

MGG

MGC

MGF

MGZ

MGT

D-□

-X□

Individual
-X□

Compact Guide Cylinder Series *MGP*

ø12, ø16, ø20, ø25, ø32, ø40, ø50, ø63, ø80, ø100

How to Order

Compact Guide Cylinder **MGP** **M** **25** **30** **M9BW** **2**

Compact Guide Cylinder •

Bearing type

M	Slide bearing
L	Ball bushing bearing

Bore size

12	12 mm	40	40 mm
16	16 mm	50	50 mm
20	20 mm	63	63 mm
25	25 mm	80	80 mm
32	32 mm	100	100 mm

Thread type

Nil	M5 x 0.8
	Rc
N	NPT
TF	G

* For bore sizes 12 and 16, only M5 x 0.8 is available.

Number of auto switches

Nil	2 pcs.
S	1 pc.
n	n pcs.

Auto switch

Nil	Without auto switch (Built-in magnet)
------------	---------------------------------------

* For the applicable auto switch model, refer to the table below.

Cylinder stroke (mm)
Refer to "Standard Stroke" on page 273.

Made to Order Specification
For details, refer to page 273.

Applicable Auto Switch/Refer to pages 1719 to 1827 for further information on auto switches.

Type	Special function	Electrical entry	Indicator light	Wiring (Output)	Load voltage		Auto switch model		Lead wire length (m)				Pre-wired connector	Applicable load						
					DC	AC	Perpendicular	In-line	0.5 (Nil)	1 (M)	3 (L)	5 (Z)								
Solid state switch	—	Grommet	Yes	3-wire (NPN)	24V	5V, 12V	—	M9NV	M9N	●	●	●	○	○	IC circuit	Relay, PLC				
				3-wire (PNP)				M9PV	M9P	●	●	●	○	○						
				2-wire				M9BV	M9B	●	●	●	○	○						
				3-wire (NPN)				M9NWV	M9NW	●	●	●	○	○						
	Diagnostic indication (2-color indication)			3-wire (PNP)	M9PWV	M9PW	●	●	●	○	○	○	○	○	○		○	IC circuit		
				2-wire	M9BWV	M9BW	●	●	●	○	○	○	○	○	○		○			
	Water resistant (2-color indication)			3-wire (NPN)	M9NAV	M9NA	○	○	●	○	○	○	○	○	○		○	IC circuit		
				3-wire (PNP)	M9PAV	M9PA	○	○	●	○	○	○	○	○	○		○			
	Magnetic field resistant (2-color indication)			2-wire	M9BAV	M9BA	○	○	●	○	○	○	○	○	○		○	—		
				2-wire (Non-polar)	—	P4DW	—	—	●	●	○	○	○	○	○		○			
Reed switch		—	Grommet	Yes	3-wire (NPN equivalent)	24V	5V	—	A96V	A96	●	—	●	—	—	—	—		IC circuit	—
					2-wire				A93V	A93	●	—	●	—	—	—	—		—	—
Reed switch	—	Grommet	No	2-wire	24V	12V	100V or less	A90V	A90	●	—	●	—	—	—	—	—	—		
								—	—	●	—	●	—	—	—	—	—	—	—	—

* Lead wire length symbols: 0.5 m..... Nil (Example) M9NW
 1 m..... M (Example) M9NWM
 3 m..... L (Example) M9NWL
 5 m..... Z (Example) M9NWZ

* Solid state auto switches marked with "○" are produced upon receipt of order.
 * D-P4DW type can be mounted on bore sizes 32 to 100.

* Since there are other applicable auto switches than listed, refer to page 336 for details.
 * For details about auto switches with pre-wired connector, refer to pages 1784 and 1785.
 * Auto switches are shipped together (not assembled).

Specifications



Bore size	ø12	ø16	ø20	ø25	ø32	ø40	ø50	ø63	ø80	ø100
Action	Double acting									
Fluid	Air									
Proof pressure	1.5 MPa									
Maximum operating pressure	1.0 MPa									
Minimum operating pressure	0.12 MPa		0.1 MPa							
Ambient and fluid temperature	-10 to 60°C (No freezing)									
Piston speed ^(Note)	50 to 500 mm/s								50 to 400 mm/s	
Cushion	Rubber bumper on both ends									
Lubrication	Not required (Non-lube)									
Stroke length tolerance	$\begin{matrix} +1.5 \\ 0 \end{matrix}$ mm									

Note) Maximum speed with no load.

Make a model selection, considering a load according to the graph on pages 275 to 281.

Standard Stroke

Bore size (mm)	Standard stroke (mm)
12, 16	10, 20, 30, 40, 50, 75, 100, 125, 150, 175, 200, 250
20, 25	20, 30, 40, 50, 75, 100, 125, 150, 175, 200, 250, 300, 350, 400
32 to 100	25, 50, 75, 100, 125, 150, 175, 200, 250, 300, 350, 400

Manufacture of Intermediate Stroke



Made to Order Specification
(For details, refer to pages 1829 to 2021.)

Symbol	Specifications
-XA□	Change of guide rod end shape
-XB6	Heat resistant cylinder (-10 to 150°C)
-XB10	Intermediate stroke (Using exclusive body)
-XB13	Low speed cylinder (5 to 50 mm/s)
-XC4	With heavy duty scraper
-XC6	Made of stainless steel
-XC8	Adjustable stroke cylinder/Adjustable extension type
-XC9	Adjustable stroke cylinder/Adjustable retraction type
-XC22	Fluororubber seals
-XC35	With coil scraper
-XC69	With shock absorber
-XC79	Machining tapped hole, drilled hole and pin hole additionally.
-XC82	Bottom mounting style
-X144	Symmetrical port position
-X867	Lateral piping type (Change of plug position)

Refer to pages 334 to 336 for cylinders with auto switches.

- Minimum auto switch mounting stroke
- Proper auto switch mounting position (detection at stroke end) and mounting height
- Operating range
- Switch mounting bracket: Part no.

Description	Spacer installation type		Exclusive body (-XB10)	
	Spacers are installed in the standard stroke cylinder. • ø12 to 32: Available by the 1 mm stroke interval. • ø40 to 100: Available by the 5 mm stroke interval.		Dealing with the stroke by making an exclusive body. • All bore sizes are available by the 1 mm interval.	
Part no.	Refer to "How to Order" for the standard model numbers.		Suffix "-XB10" to the end of standard part number. ^(Note)	
Applicable stroke (mm)	ø12, ø16	1 to 249	ø12, ø16	11 to 249
	ø20, ø25, ø32	1 to 399	ø20, ø25	21 to 399
	ø40 to ø100	5 to 395	ø32 to ø100	26 to 399
Example	Part no.: MGPM20-39 A spacer 1 mm in width is installed in a MGPM20-40. C dimension is 77 mm.		Part no.: MGPM20-39-XB10 Special body manufactured for 39 stroke. C dimension is 76 mm.	

Theoretical Output

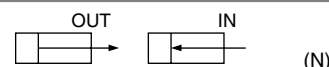

Bore size (mm)	Rod size (mm)	Operating direction	Piston area (mm ²)	Operating pressure (MPa)								
				0.2	0.3	0.4	0.5	0.6	0.7	0.8	0.9	1.0
12	6	OUT	113	23	34	45	57	68	79	90	102	113
		IN	85	17	26	34	43	51	60	68	77	85
16	8	OUT	201	40	60	80	101	121	141	161	181	201
		IN	151	30	45	60	76	91	106	121	136	151
20	10	OUT	314	63	94	126	157	188	220	251	283	314
		IN	236	47	71	94	118	142	165	189	212	236
25	12	OUT	491	98	147	196	246	295	344	393	442	491
		IN	378	76	113	151	189	227	265	302	340	378
32	16	OUT	804	161	241	322	402	482	563	643	724	804
		IN	603	121	181	241	302	362	422	482	543	603
40	16	OUT	1257	251	377	503	629	754	880	1006	1131	1257
		IN	1056	211	317	422	528	634	739	845	950	1056
50	20	OUT	1963	393	589	785	982	1178	1374	1570	1767	1963
		IN	1649	330	495	660	825	990	1154	1319	1484	1649
63	20	OUT	3117	623	935	1247	1559	1870	2182	2494	2805	3117
		IN	2803	561	841	1121	1402	1682	1962	2242	2523	2803
80	25	OUT	5027	1005	1508	2011	2514	3016	3519	4022	4524	5027
		IN	4536	907	1361	1814	2268	2722	3175	3629	4082	4536
100	30	OUT	7854	1571	2356	3142	3927	4712	5498	6283	7069	7854
		IN	7147	1429	2144	2859	3574	4288	5003	5718	6432	7147

Note) Theoretical output (N) = Pressure (MPa) x Piston area (mm²)

MGJ

MGP

MGQ

MGG

MGC

MGF

MGZ

MGT

D-□

-X□

Individual
-X□

Series MGP

Mass

Slide Bearing: MGPM12 to 100

(kg)

Bore size (mm)	Model	Standard stroke (mm)															
		10	20	25	30	40	50	75	100	125	150	175	200	250	300	350	400
12	MGPM12	0.24	0.28	—	0.31	0.35	0.39	0.50	0.59	0.70	0.79	0.89	0.98	1.17	—	—	—
16	MGPM16	0.33	0.38	—	0.43	0.48	0.53	0.68	0.80	0.97	1.09	1.22	1.35	1.60	—	—	—
20	MGPM20	—	0.67	—	0.75	0.83	0.91	1.17	1.37	1.57	1.76	1.96	2.16	2.63	3.03	3.42	3.82
25	MGPM25	—	0.95	—	1.05	1.16	1.27	1.65	1.92	2.19	2.47	2.74	3.01	3.67	4.21	4.76	5.30
32	MGPM32	—	—	1.69	—	—	2.07	2.47	2.85	3.24	3.62	4.00	4.38	5.33	6.09	6.86	7.62
40	MGPM40	—	—	1.95	—	—	2.37	2.83	3.25	3.68	4.10	4.53	4.95	5.99	6.85	7.70	8.55
50	MGPM50	—	—	3.36	—	—	4.00	4.73	5.37	6.01	6.65	7.29	7.93	9.54	10.8	12.1	13.4
63	MGPM63	—	—	4.18	—	—	4.94	5.78	6.54	7.29	8.05	8.80	9.56	11.4	12.9	14.4	15.9
80	MGPM80	—	—	6.49	—	—	7.43	8.67	9.61	10.5	11.5	12.4	13.4	15.8	17.7	19.5	21.4
100	MGPM100	—	—	10.5	—	—	11.9	13.6	14.9	16.3	17.6	18.9	20.2	23.6	26.2	28.9	31.5

Ball Bushing Bearing: MGPL12 to 100

(kg)

Bore size (mm)	Model	Standard stroke (mm)															
		10	20	25	30	40	50	75	100	125	150	175	200	250	300	350	400
12	MGPL12	0.24	0.27	—	0.30	0.35	0.39	0.47	0.56	0.66	0.74	0.83	0.91	1.08	—	—	—
16	MGPL16	0.34	0.39	—	0.43	0.51	0.56	0.67	0.79	0.93	1.04	1.16	1.28	1.50	—	—	—
20	MGPL20	—	0.70	—	0.77	0.89	0.97	1.14	1.31	1.52	1.69	1.87	2.04	2.42	2.77	3.12	3.47
25	MGPL25	—	0.98	—	1.07	1.25	1.34	1.57	1.81	2.08	2.31	2.54	2.77	3.27	3.74	4.20	4.66
32	MGPL32	—	—	1.54	—	—	1.85	2.30	2.62	2.99	3.31	3.62	3.94	4.63	5.26	5.89	6.52
40	MGPL40	—	—	1.79	—	—	2.15	2.64	3.00	3.42	3.78	4.14	4.50	5.28	6.00	6.72	7.44
50	MGPL50	—	—	3.11	—	—	3.66	4.41	4.96	5.60	6.15	6.70	7.25	8.48	9.57	10.7	11.8
63	MGPL63	—	—	3.93	—	—	4.59	5.46	6.12	6.88	7.54	8.21	8.87	10.3	11.7	13.0	14.3
80	MGPL80	—	—	6.25	—	—	7.39	8.69	9.51	10.3	11.1	12.0	12.8	14.7	16.3	18.0	19.6
100	MGPL100	—	—	9.89	—	—	11.6	13.4	14.5	15.7	16.9	18.1	19.3	21.9	24.2	26.6	28.9

Allowable Rotational Torque of Plate

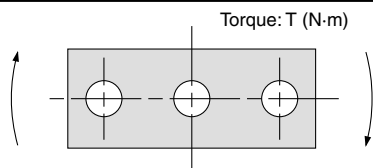

Non-rotating Accuracy of Plate

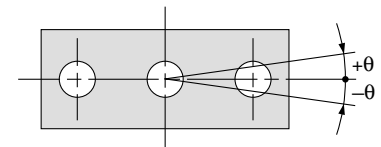

For non-rotating accuracy without load, use a value no more than the values in the table as a guide.

Bore size (mm)	Bearing type	Stroke (mm)															
		10	20	25	30	40	50	75	100	125	150	175	200	250	300	350	400
12	MGPM	0.39	0.32	—	0.27	0.24	0.21	0.43	0.36	0.31	0.27	0.24	0.22	0.19	—	—	—
	MGPL	0.61	0.45	—	0.35	0.58	0.50	0.37	0.29	0.24	0.20	0.18	0.16	0.12	—	—	—
16	MGPM	0.69	0.58	—	0.49	0.43	0.38	0.69	0.58	0.50	0.44	0.40	0.36	0.30	—	—	—
	MGPL	0.99	0.74	—	0.59	0.99	0.86	0.65	0.52	0.43	0.37	0.32	0.28	0.23	—	—	—
20	MGPM	—	1.05	—	0.93	0.83	0.75	1.88	1.63	1.44	1.28	1.16	1.06	0.90	0.78	0.69	0.62
	MGPL	—	1.26	—	1.03	2.17	1.94	1.52	1.25	1.34	1.17	1.03	0.93	0.76	0.65	0.56	0.49
25	MGPM	—	1.76	—	1.55	1.38	1.25	2.96	2.57	2.26	2.02	1.83	1.67	1.42	1.24	1.09	0.98
	MGPL	—	2.11	—	1.75	3.37	3.02	2.38	1.97	2.05	1.78	1.58	1.41	1.16	0.98	0.85	0.74
32	MGPM	—	—	6.35	—	—	5.13	5.69	4.97	4.42	3.98	3.61	3.31	2.84	2.48	2.20	1.98
	MGPL	—	—	5.95	—	—	4.89	5.11	4.51	6.34	5.79	5.33	4.93	4.29	3.78	3.38	3.04
40	MGPM	—	—	7.00	—	—	5.66	6.27	5.48	4.87	4.38	3.98	3.65	3.13	2.74	2.43	2.19
	MGPL	—	—	6.55	—	—	5.39	5.62	4.96	6.98	6.38	5.87	5.43	4.72	4.16	3.71	3.35
50	MGPM	—	—	13.0	—	—	10.8	12.0	10.6	9.50	8.60	7.86	7.24	6.24	5.49	4.90	4.43
	MGPL	—	—	9.17	—	—	7.62	9.83	8.74	11.6	10.7	9.83	9.12	7.95	7.02	6.26	5.63
63	MGPM	—	—	14.7	—	—	12.1	13.5	11.9	10.7	9.69	8.86	8.16	7.04	6.19	5.52	4.99
	MGPL	—	—	10.2	—	—	8.48	11.0	9.74	13.0	11.9	11.0	10.2	8.84	7.80	6.94	6.24
80	MGPM	—	—	21.9	—	—	18.6	22.9	20.5	18.6	17.0	15.6	14.5	12.6	11.2	10.0	9.11
	MGPL	—	—	15.1	—	—	23.3	22.7	20.6	18.9	17.3	16.0	14.8	12.9	11.3	10.0	8.94
100	MGPM	—	—	38.8	—	—	33.5	37.5	33.8	30.9	28.4	26.2	24.4	21.4	19.1	17.2	15.7
	MGPL	—	—	27.1	—	—	30.6	37.9	34.6	31.8	29.3	27.2	25.3	22.1	19.5	17.3	15.5

Bore size (mm)	Non-rotating accuracy θ	
	MGPM	MGPL
12		
16	$\pm 0.08^\circ$	$\pm 0.10^\circ$
20		
25	$\pm 0.07^\circ$	$\pm 0.09^\circ$
32		
40	$\pm 0.06^\circ$	$\pm 0.08^\circ$
50		
63	$\pm 0.05^\circ$	$\pm 0.06^\circ$
80		
100	$\pm 0.04^\circ$	$\pm 0.05^\circ$

Series MGP Model Selection

Selection Conditions

Mounting orientation	Vertical		Horizontal	
Maximum speed (mm/s)	200 or less	400	200 or less	400
Graph (Slide bearing type)	(1), (2)	(3), (4)	(13), (14)	(15), (16)
Graph (Ball bushing bearing type)	(5) to (8)	(9) to (12)	(17), (18)	(19), (20)

Selection Example 1 (Vertical Mounting)

Selection conditions

Mounting: Vertical
 Bearing type: Ball bushing
 Stroke: 30 stroke
 Maximum speed: 200 mm/s
 Load mass: 3 kg
 Eccentric distance: 90 mm

Find the point of intersection for the load mass of 3 kg and the eccentric distance of 90 mm on graph (5), based on vertical mounting, ball bushing, 30 stroke, and the speed of 200 mm/s.

→ MGPL25-30 is selected.

(5) Less than 40 stroke, V = 200 mm/s or less

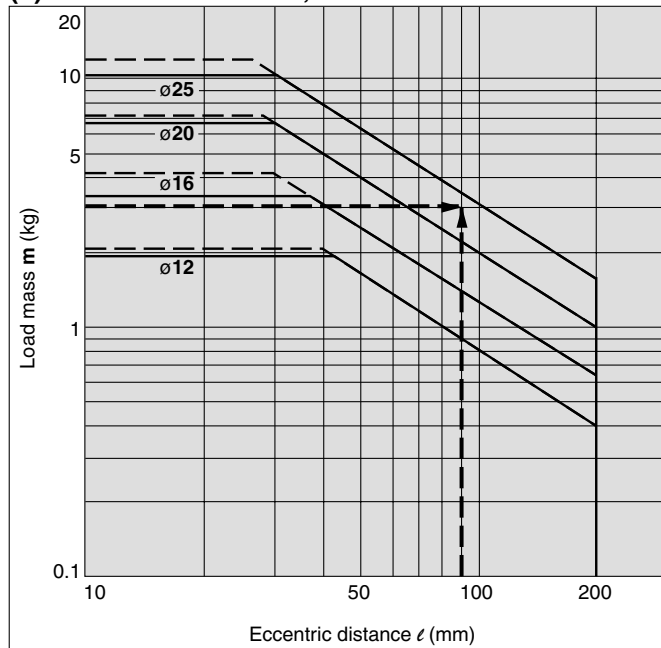

Selection Example 2 (Horizontal Mounting)

Selection conditions

Mounting: Horizontal
 Bearing type: Slide bearing
 Distance between plate and load center of gravity: 50 mm
 Maximum speed: 200 mm/s
 Load mass: 2 kg
 Stroke: 30 stroke

Find the point of intersection for the load mass of 2 kg and 30 stroke on graph (13), based on horizontal mounting, slide bearing, the distance of 50 mm between the plate and load center of gravity, and the speed of 200 mm/s.

→ MGPM20-30 is selected.

(13) $l = 50$ mm, V = 200 mm/s or less

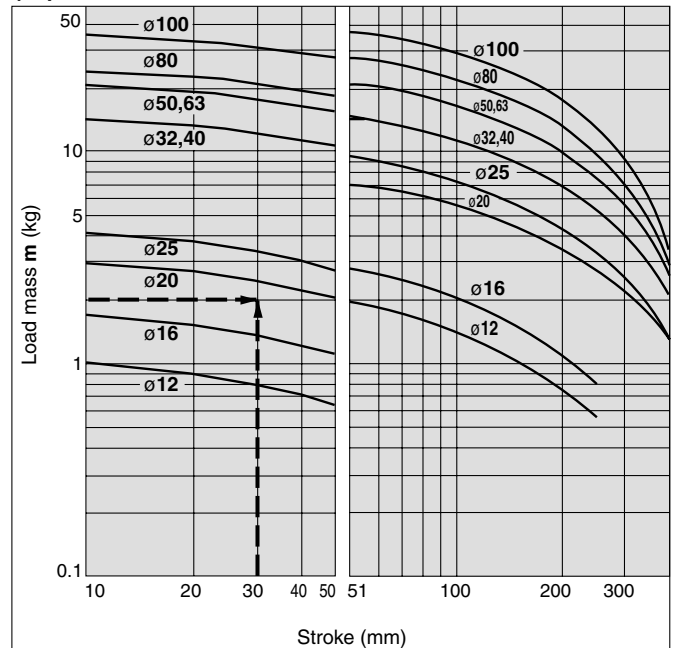

· When the maximum speed exceeds 200 mm/s, the allowable load mass is determined by multiplying the value shown in the graph at 400 mm/s by the coefficient listed in the table below.

Maximum	Up to 300 mm/s	Up to 400 mm/s	Up to 500 mm/s
Coefficient	1.7	1	0.6

MGJ

MGP

MGQ

MGG

MGC

MGF

MGZ

MGT

D-

-X

Individual
-X

Series MGP

Vertical Mounting (Slide Bearing)

— Operating pressure 0.4 MPa
 - - - Operating pressure 0.5 MPa or more

MGPM12 to 100

(1) 50 Stroke or Less, V = 200 mm/s or less

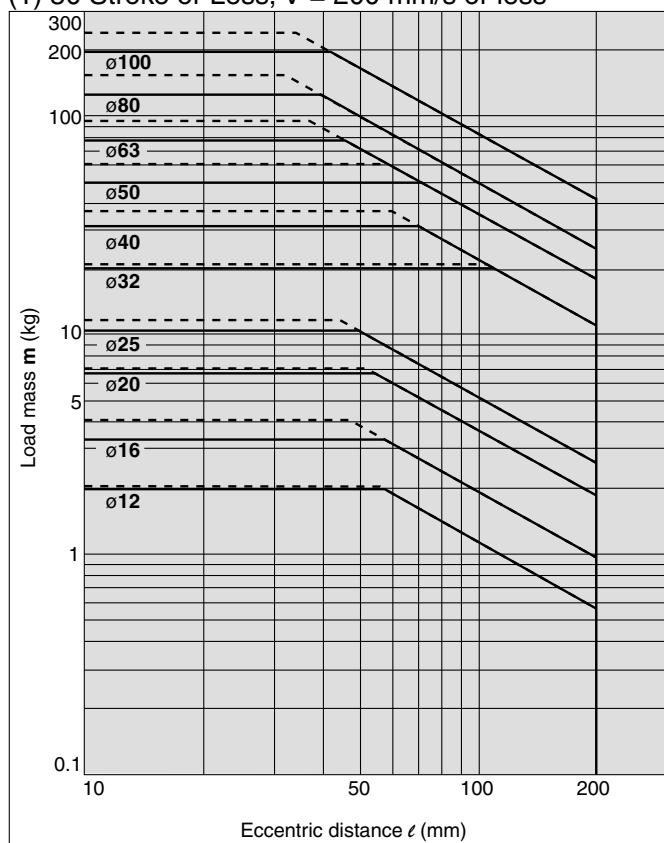

(2) Over 50 Stroke, V = 200 mm/s or less

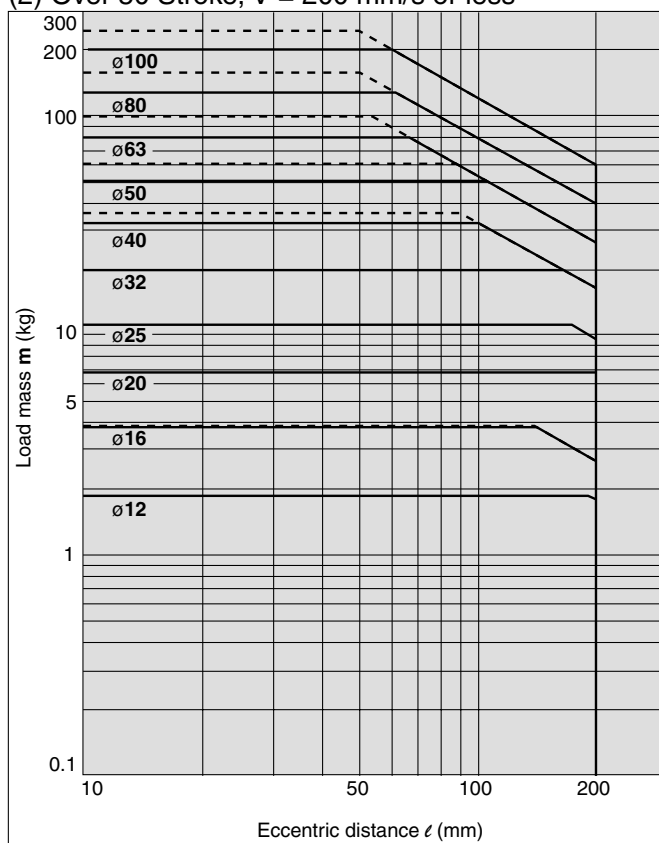

(3) 50 Stroke or Less, V = 400 mm/s

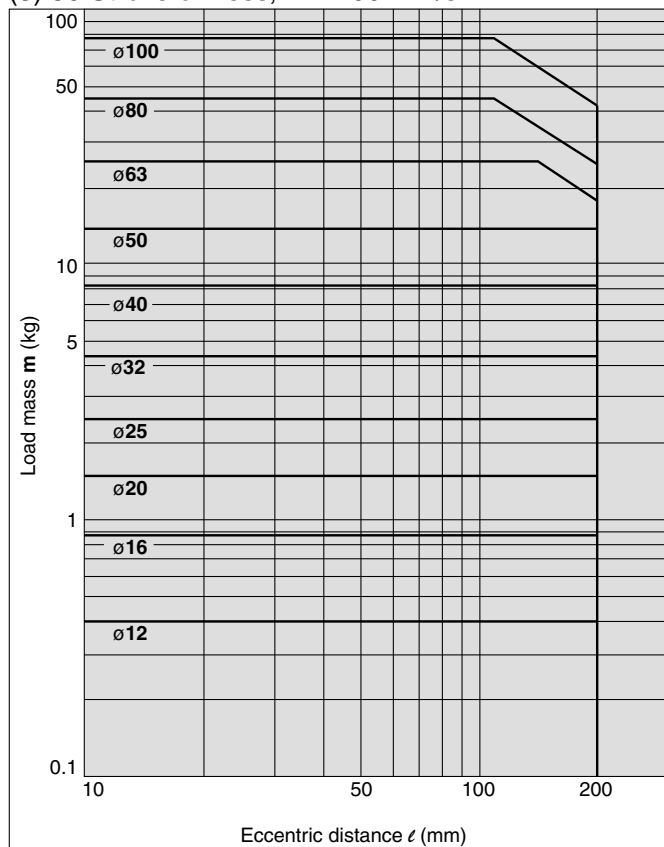

(4) Over 50 Stroke, V = 400 mm/s

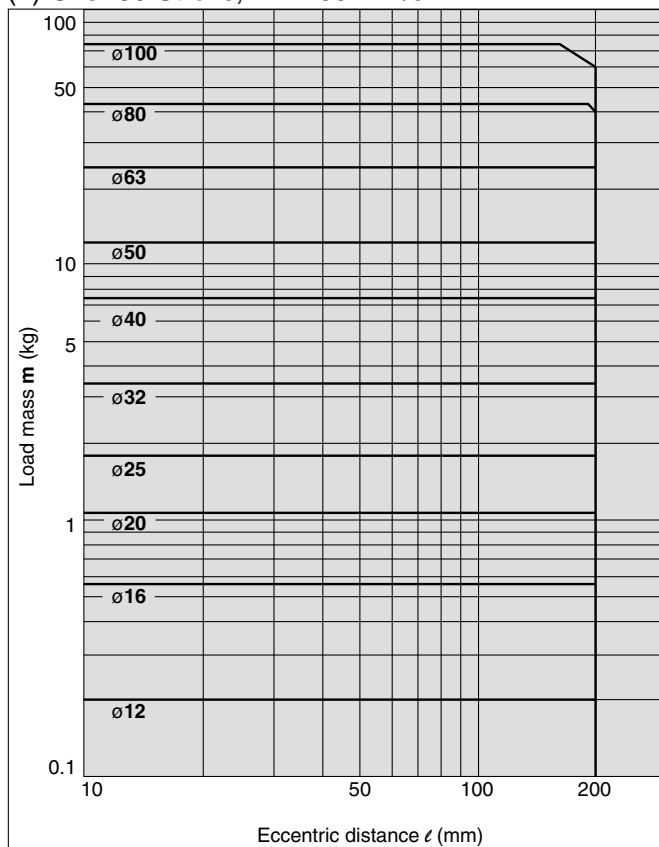

Vertical Mounting (Ball Bushing)

— Operating pressure 0.4 MPa
 - - - - Operating pressure 0.5 MPa or more

MGPL12 to 25

(5) 30 Stroke or Less, V = 200 mm/s or less

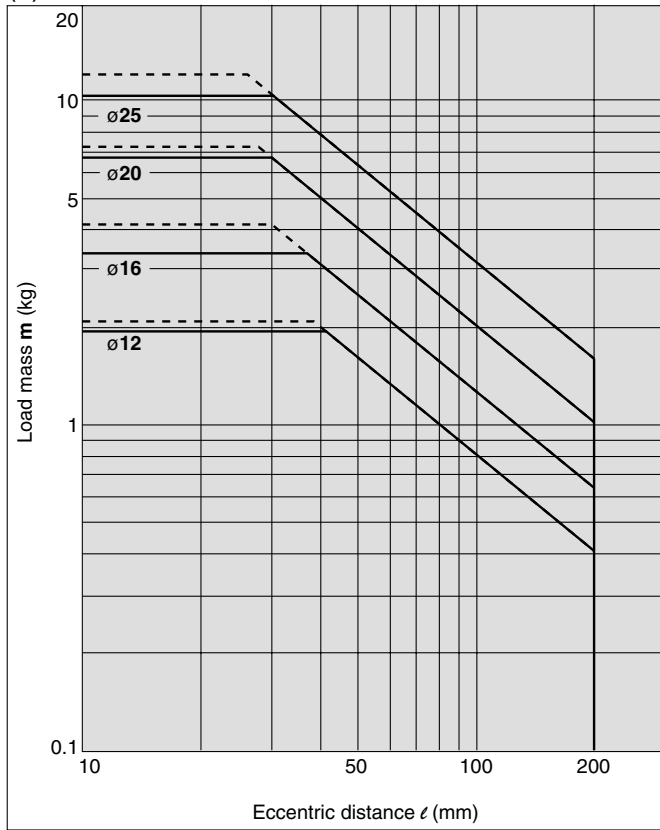

(6) Over 30 Stroke, V = 200 mm/s or less

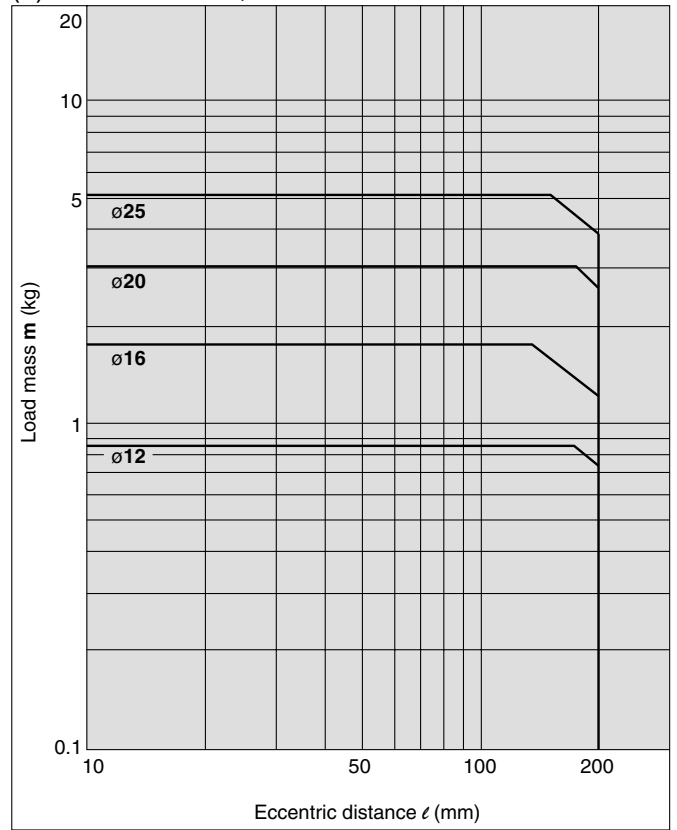

MGPL32 to 100

(7) 50 Stroke or Less, V = 200 mm/s or less

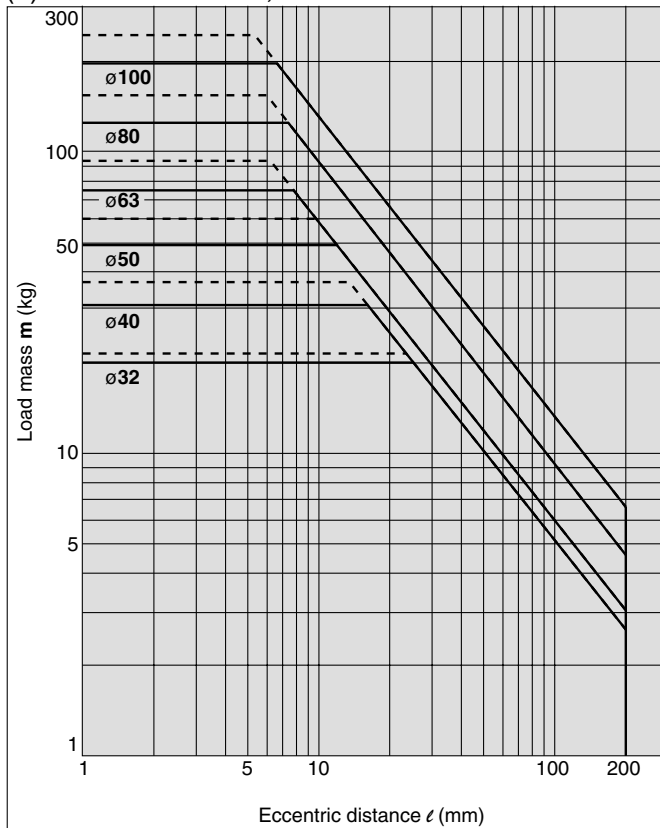

(8) Over 50 Stroke, V = 200 mm/s or less

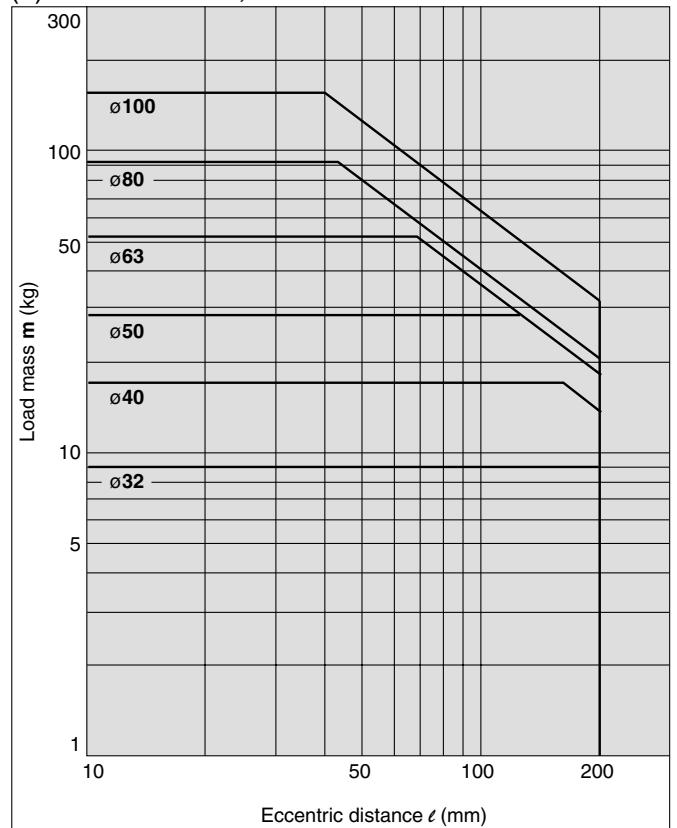

MGJ

MGP

MGQ

MGG

MGK

MGF

MGZ

MGT

D-□

-X□

Individual
-X□

Series MGP

Vertical Mounting (Ball Bushing)

Operating pressure 0.4 MPa

MGPL12 to 25

(9) 30 Stroke or Less, V = 400 mm/s

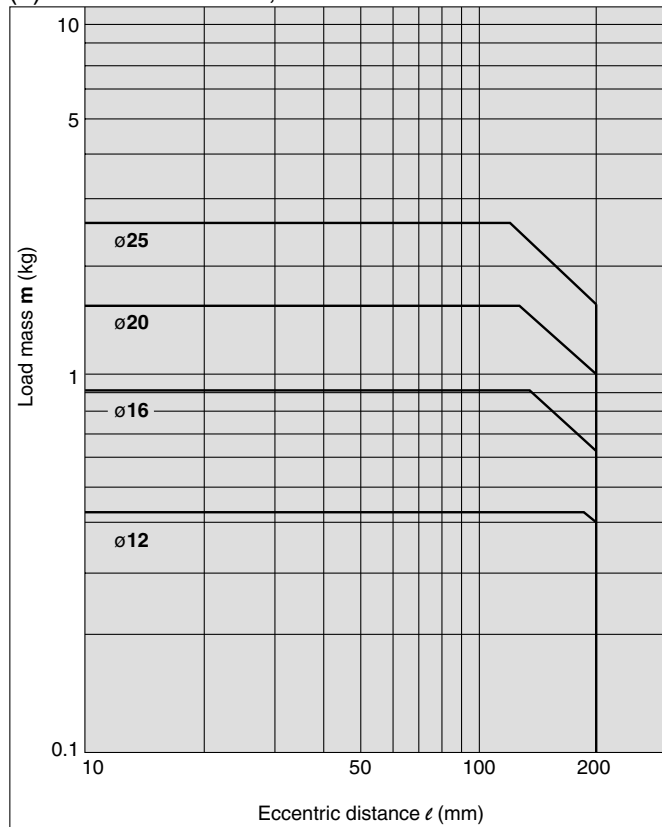

(10) Over 30 Stroke, V = 400 mm/s

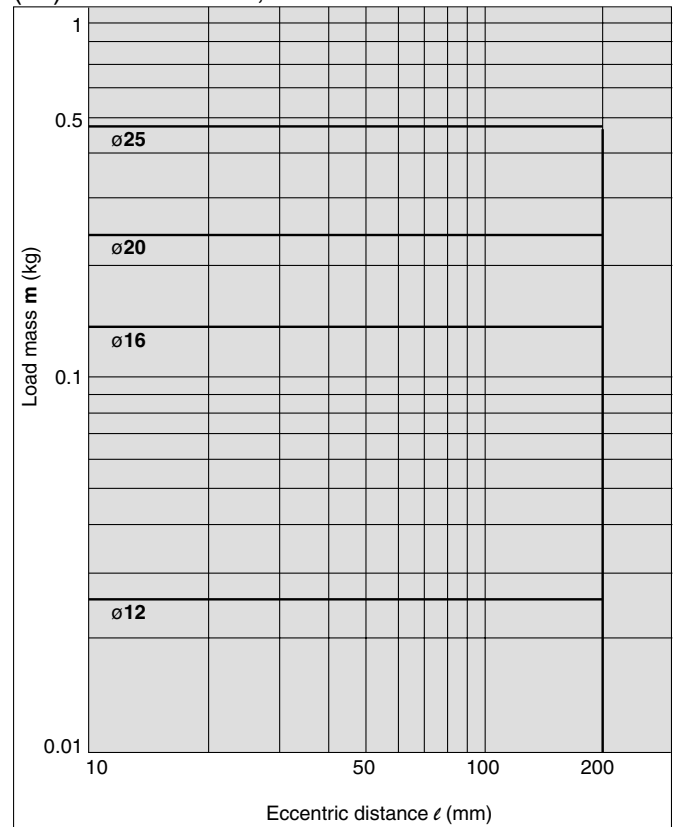

MGPL32 to 100

(11) 50 Stroke or Less, V = 400 mm/s

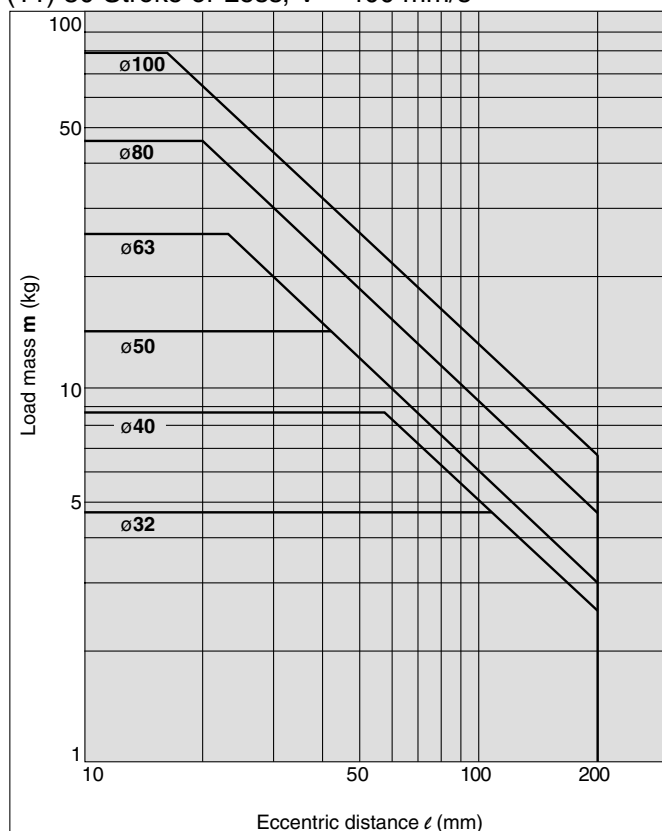

(12) Over 50 Stroke, V = 400 mm/s

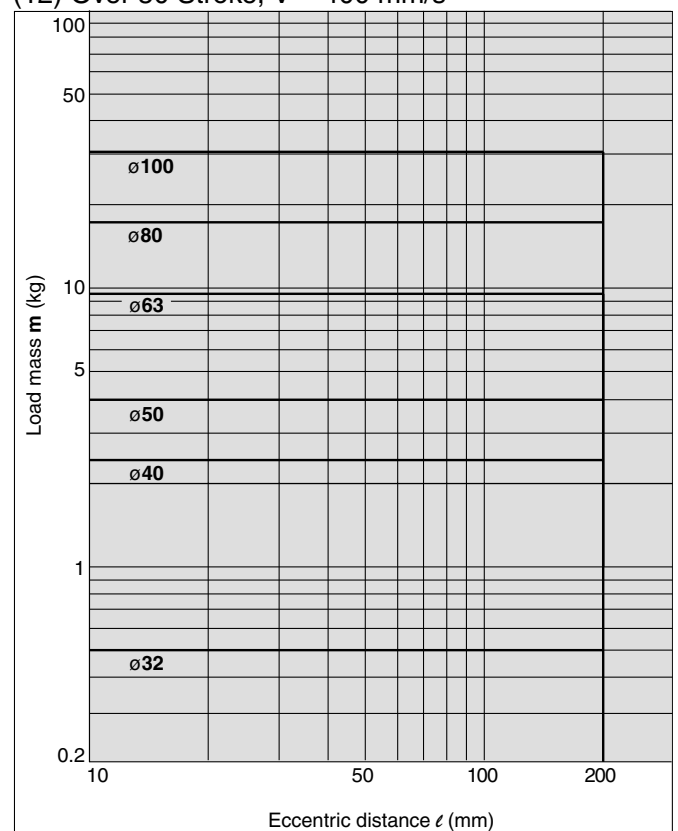

Horizontal Mounting (Slide Bearing)

MGPM12 to 100

(13) $\ell = 50$ mm, $V = 200$ mm/s or less

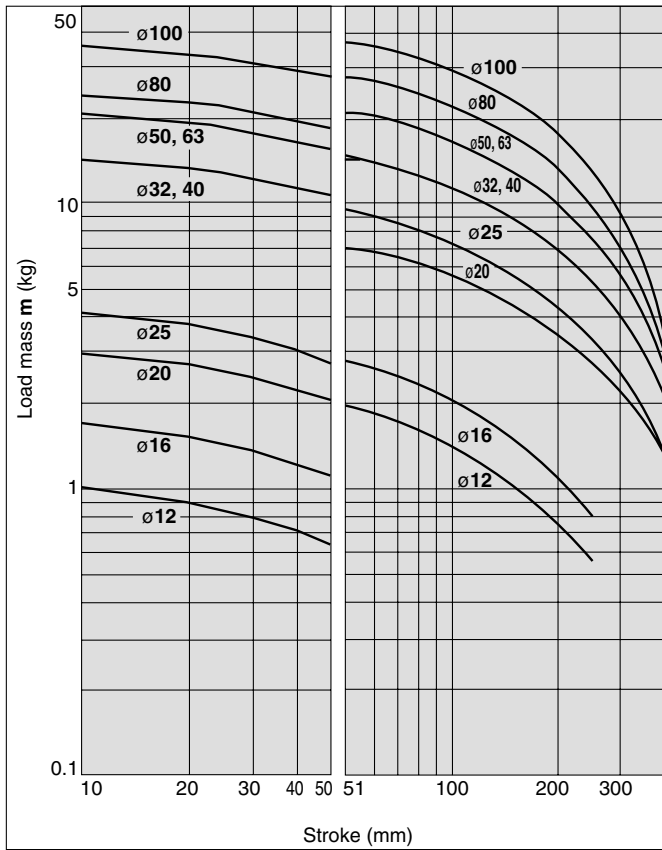

(14) $\ell = 100$ mm, $V = 200$ mm/s or less

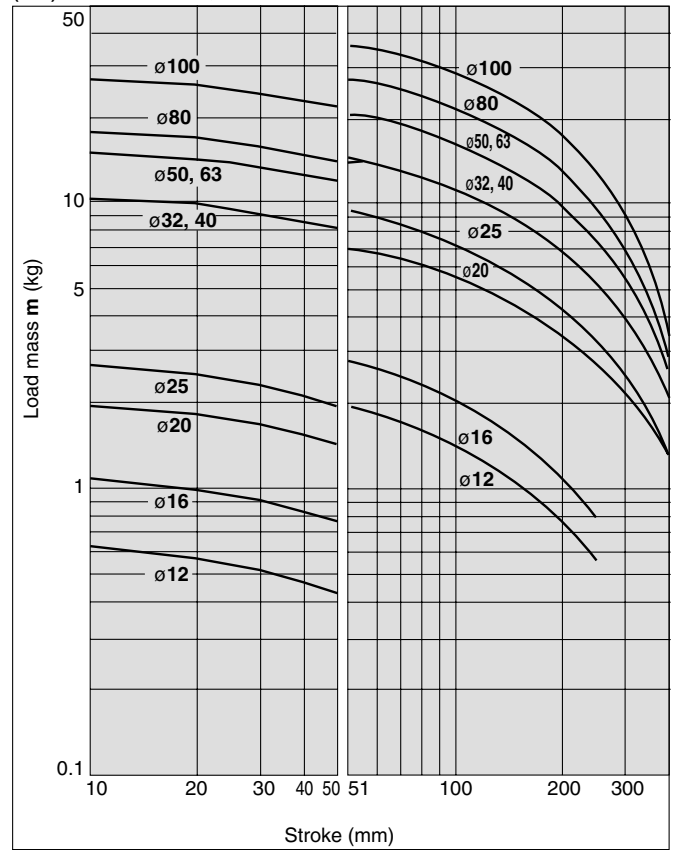

(15) $\ell = 50$ mm, $V = 400$ mm/s

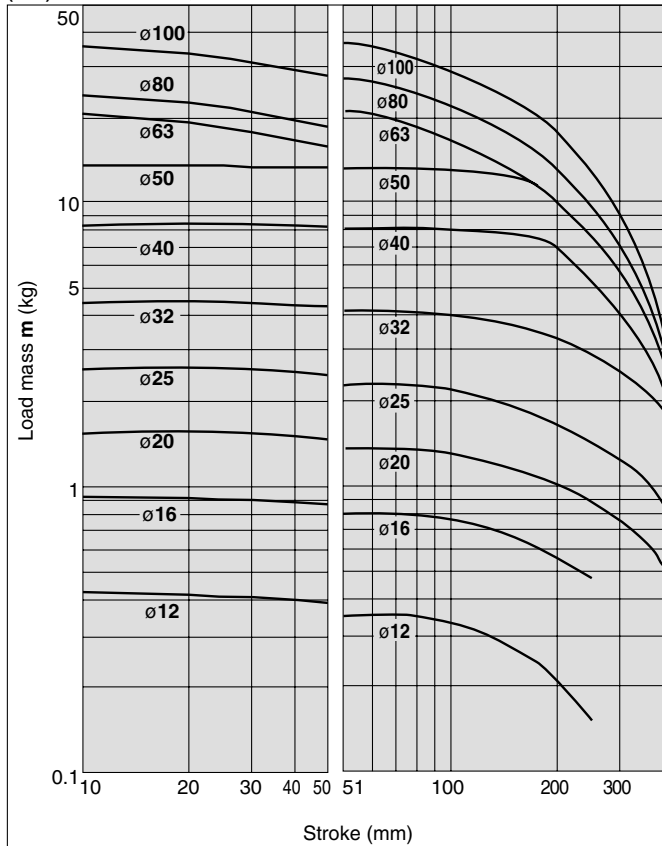

(16) $\ell = 100$ mm, $V = 400$ mm/s

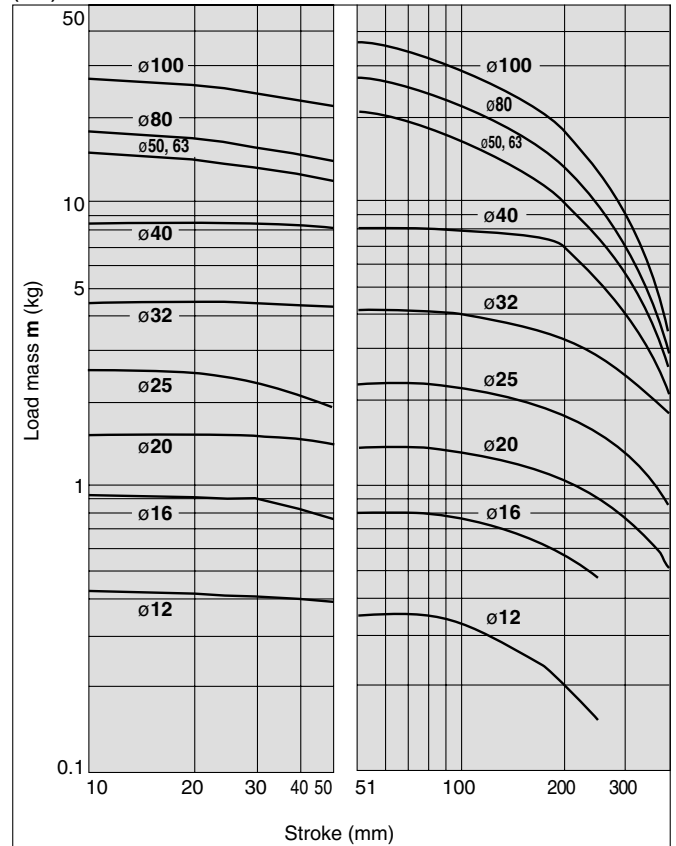

MGJ

MGP

MGQ

MGG

MGC

MGF

MGZ

MGT

D-□

-X□

Individual
-X□

Series MGP

Horizontal Mounting (Ball Bushing)

(17) $\ell = 50$ mm, $V = 200$ mm/s or less

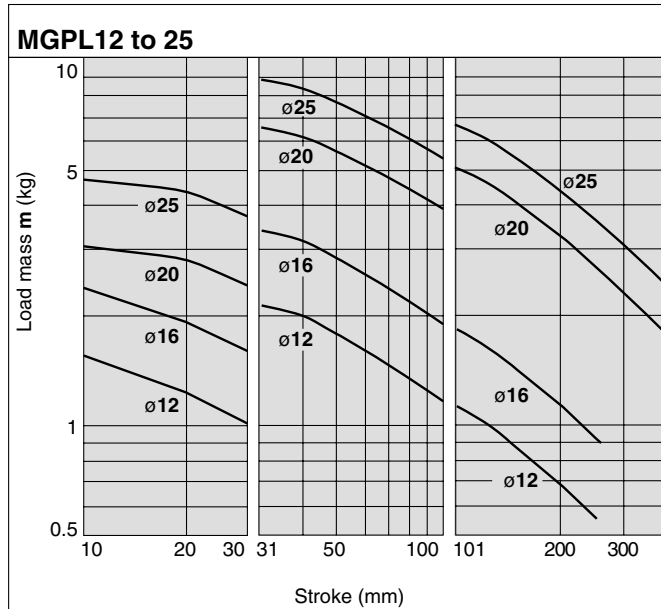

MGPL32 to 63

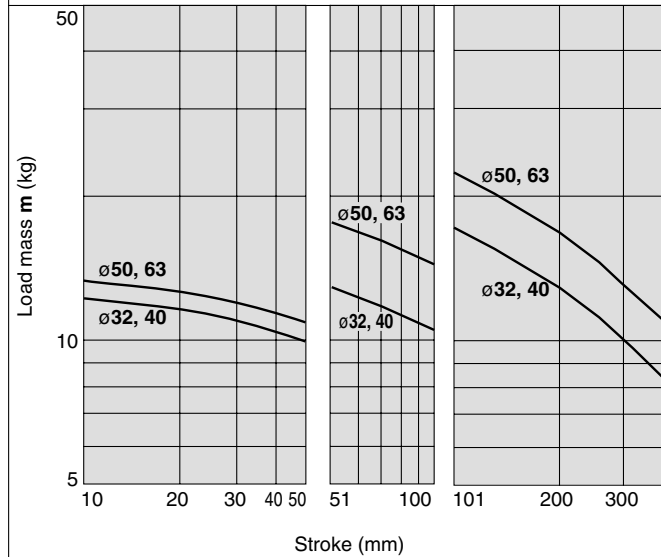

MGPL80, 100

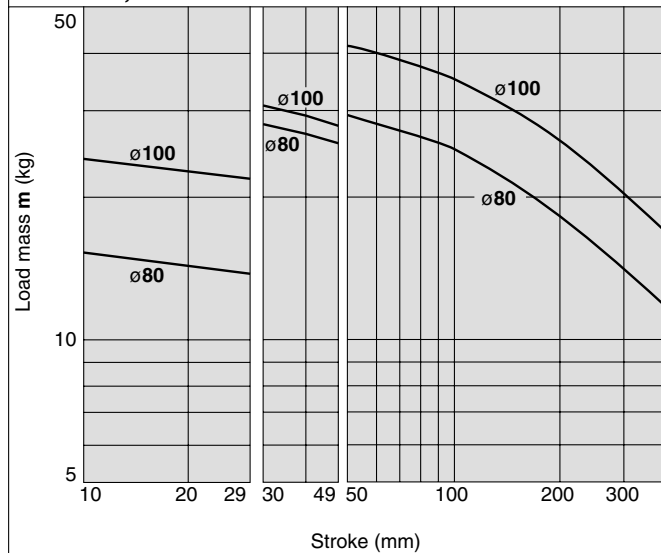

(18) $\ell = 100$ mm, $V = 200$ mm/s or less

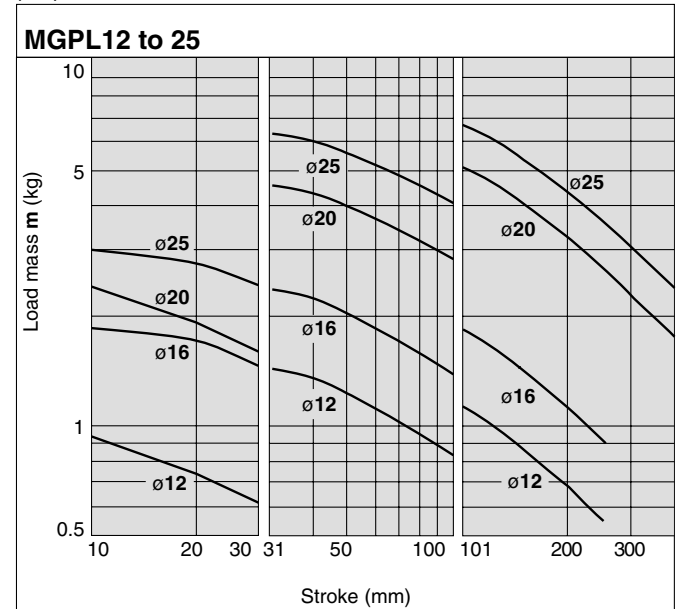

MGPL32 to 63

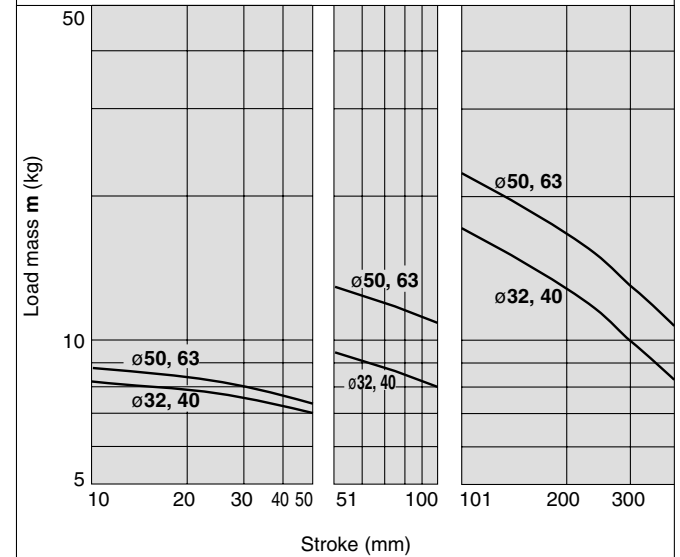

MGPL80, 100

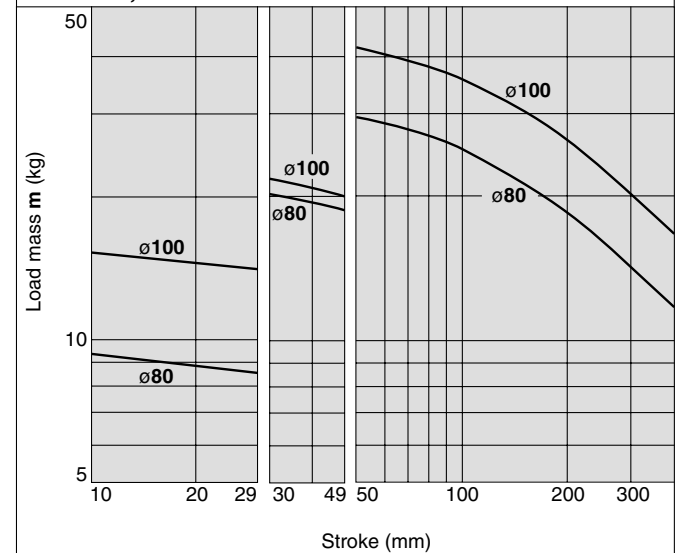

Horizontal Mounting (Ball Bushing)

(19) $\ell = 50$ mm, $V = 400$ mm/s

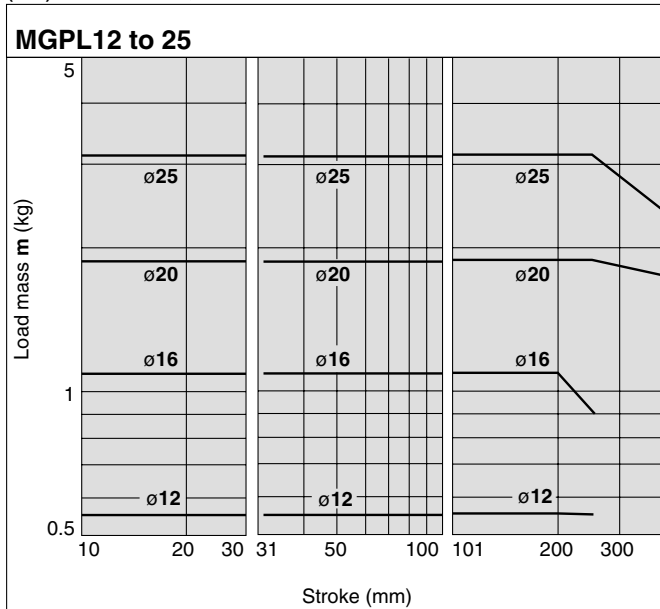

(20) $\ell = 100$ mm, $V = 400$ mm/s

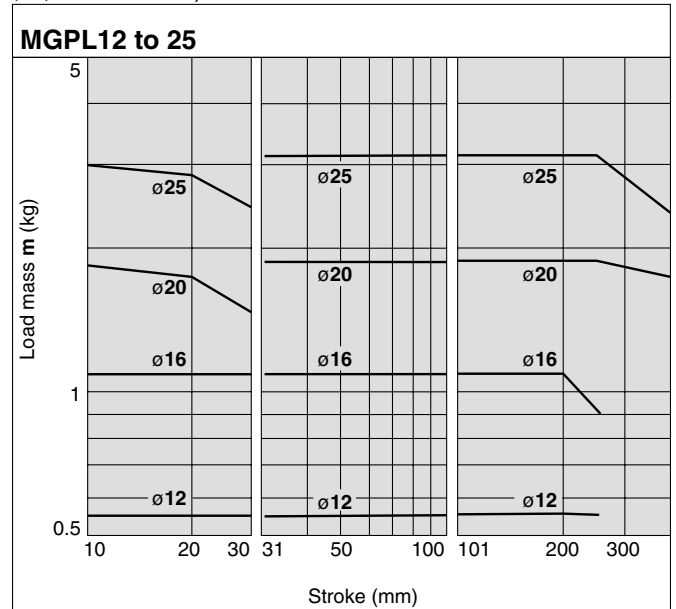

MGPL32 to 63

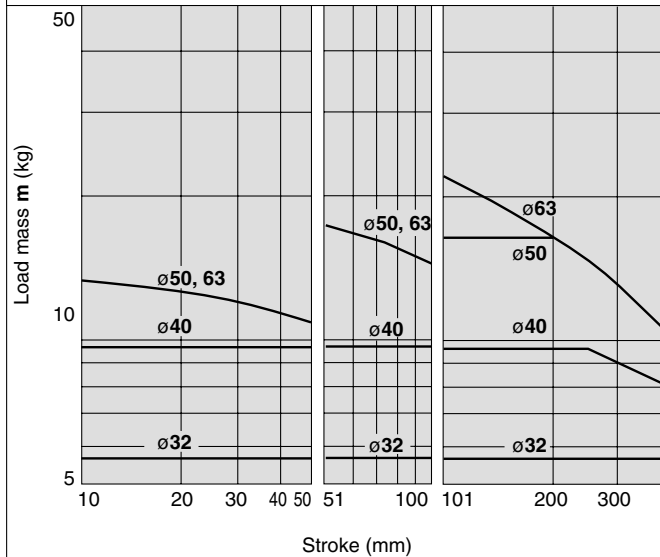

MGPL32 to 63

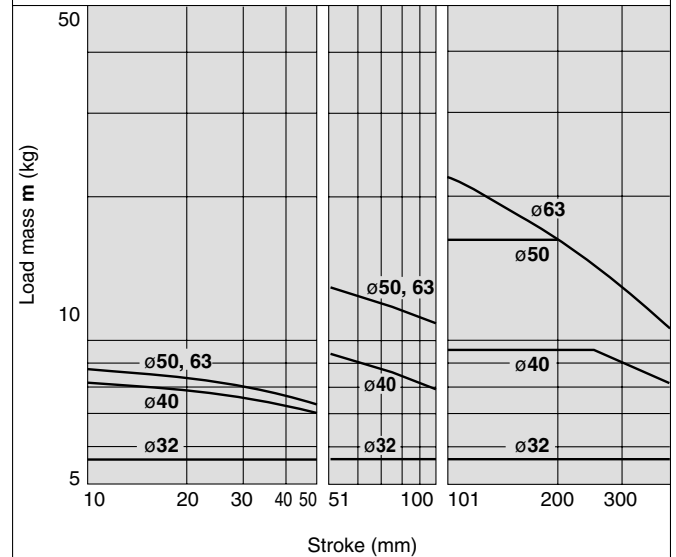

MGPL80, 100

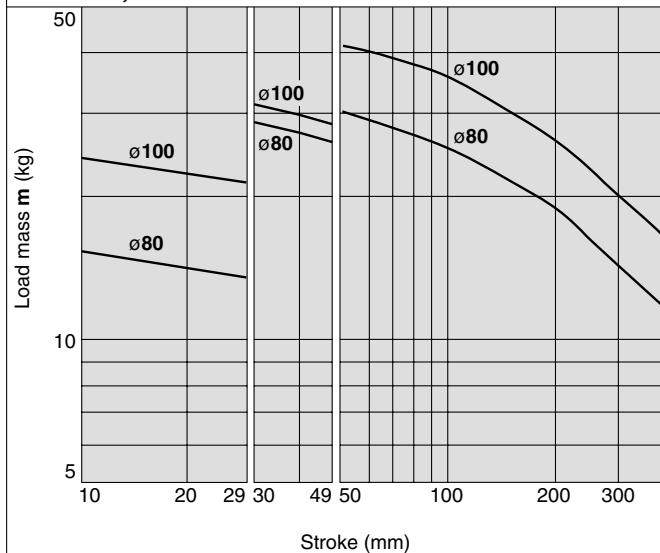

MGPL80, 100

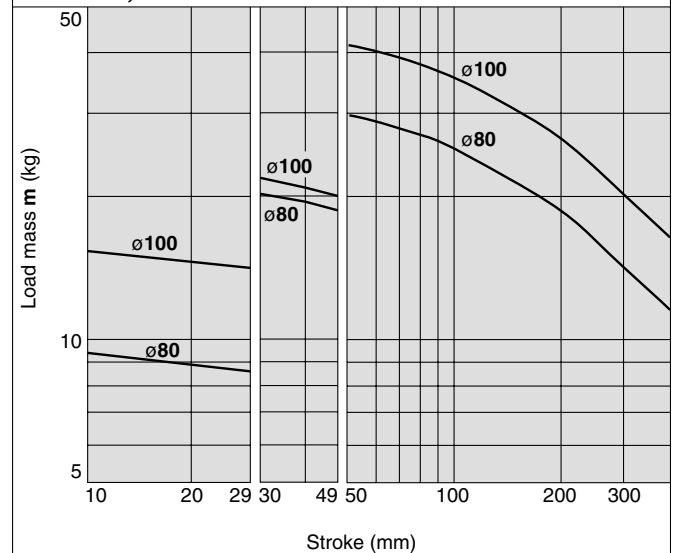

MGJ

MGP

MGQ

MGG

MGC

MGF

MGZ

MGT

D-

-X

Individual
-X

Series MGP

Operating Range when Used as Stopper

Bore Size: $\phi 12$ to 25/MGPM12 to 25 (Slide bearing)

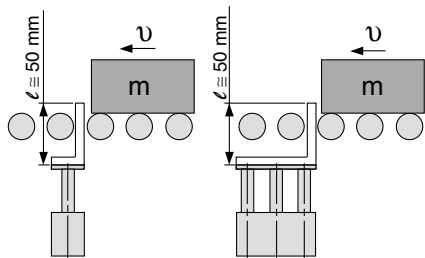

* When selecting a model with a longer l dimension, be sure to choose a bore size which is sufficiently large.

⚠ Caution

Caution on handling

Note 1) When using as a stopper, select a model with 30 stroke or less.

Note 2) Model MGPL (Ball bushing bearing) cannot be used as a stopper.

MGPM12 to 25 (Slide bearing)

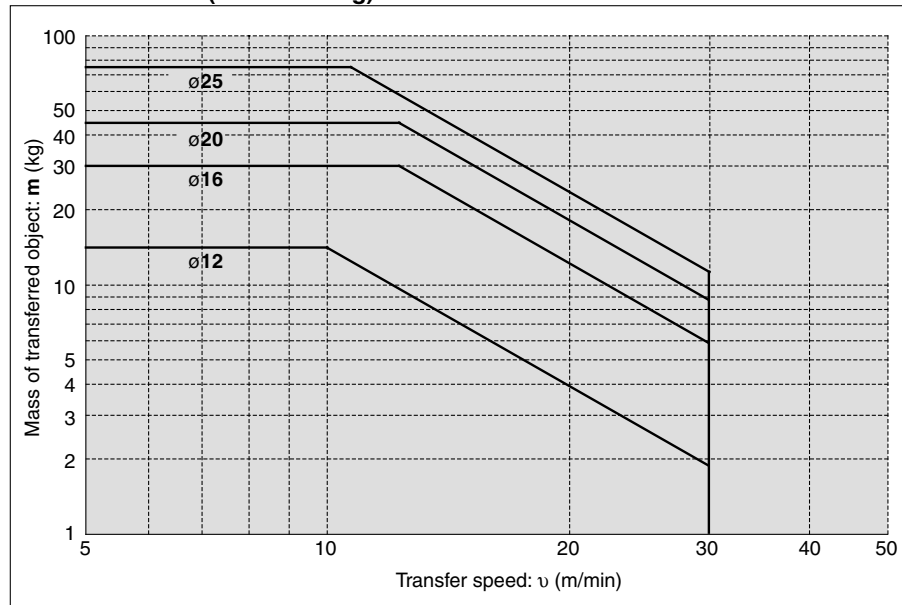

Bore Size: $\phi 32$ to 100/MGPM32 to 100 (Slide bearing)

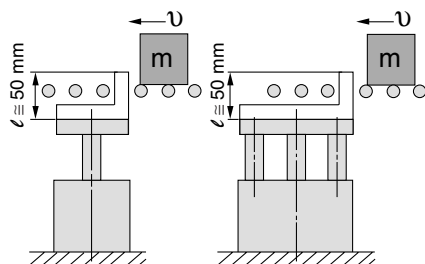

* When selecting a model with a longer l dimension, be sure to choose a bore size which is sufficiently large.

⚠ Caution

Caution on handling

Note 1) When using as a stopper, select a model with 50 stroke or less.

Note 2) Model MGPL (Ball bushing bearing) cannot be used as a stopper.

MGPM32 to 100 (Slide bearing)

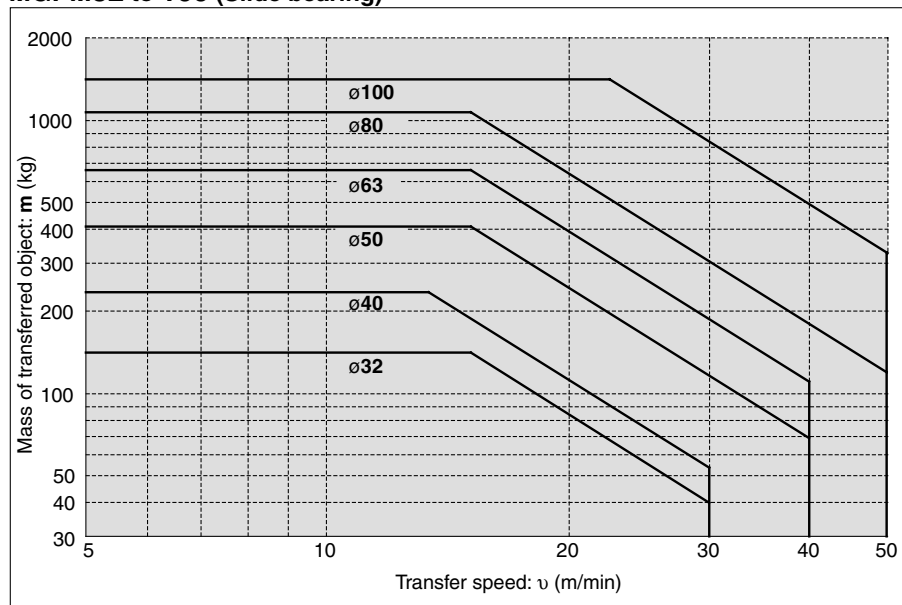

1. Water Resistant

Ideal for use in a machine tool environment exposed to coolants. Applicable for use in an environment with water splashing such as food processing and car wash equipment, etc.

Specifications

Applicable series		MGPM
Bearing type		Slide bearing
Bore size (mm)		20, 25, 32, 40, 50, 63, 80, 100
Cushion	MGPM□□R	Rubber bumper
	MGPM□□V	Without cushion

* Specifications other than above are the same as standard, basic style.

How to Order

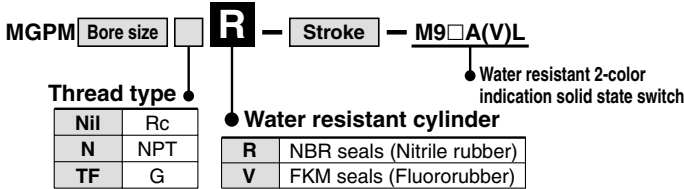

* Stainless steel parts are available as made-to-order products.
* Piston rod and guide rod are made of stainless steel.

Dimensions

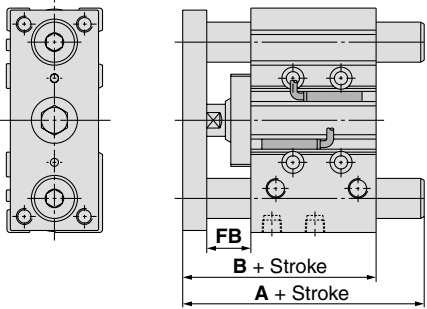

Bore size (mm)	A			B	FB
	50 st or less	Over 50 st to 200 st	Over 200 st		
20	66	97.5	135	66	19
25	67.5	99	136	67.5	20
32	109	114	152	71.5	22
40	109	114	152	78	22
50	117.5	129	172	83	23
63	117.5	129	172	88	23
80	121	148	199	102.5	24
100	141	166	207	120	29

(mm)

* Other dimensions are the same as standard type.

2. Copper and fluorine-free (For CRT manufacturing process)

To prevent the influence of copper ions or halogen ions during CRT manufacturing processes, copper and fluorine materials are not used in the component parts.

Specifications

Applicable series	MGPM	MGPL
Bearing type	Slide bearing	Ball bushing bearing
Bore size (mm)	12, 16, 20, 25, 32, 40, 50, 63, 80, 100	

* Specifications and dimensions other than above are the same as the standard, basic style.

How to Order

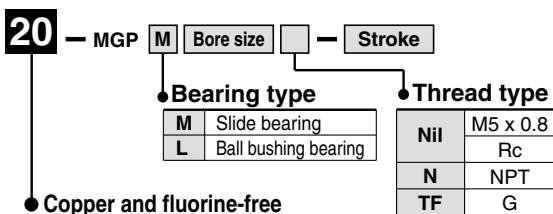

* For bore sizes 12 and 16, M5 x 0.8 is only available.

3. Clean Series

Applicable in a clean room environment. Ideal for use in conveyor lines for semiconductor (LSI), liquid crystal (LCD), food processing, pharmaceutical, and electronic parts, etc.

Specifications

Applicable series		MGPL							
Bearing type		Ball bushing bearing							
Bore size (mm)		12	16	20	25	32	40	50	63
Stroke (mm)		10 to 250		20 to 400		25 to 400			

* Specifications other than above are the same as standard, basic style.

How to Order

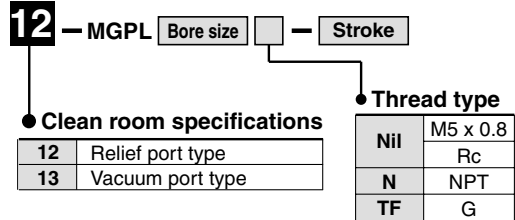

* For bore sizes 12 and 16, M5 x 0.8 is only available.

Dimensions

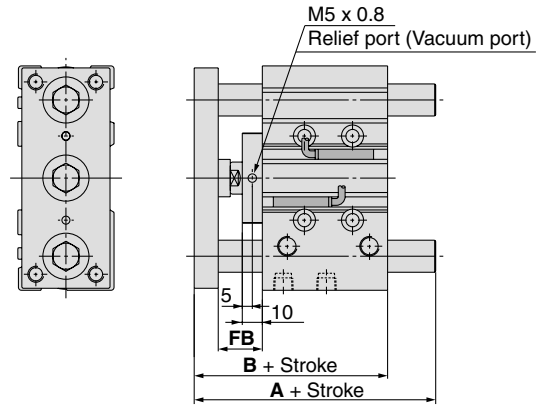

Bore size (mm)	A				B	FB
	30 st or less	Over 30 st to 100 st	Over 100 st to 200 st	Over 200 st		
12	56	68	98	98	55	18
16	62	78	108	108	59	18
20	76	93	117	135	66	19
25	82.5	98.5	117.5	135	66.5	19

(mm)

Bore size (mm)	A				B	FB
	50 st or less	Over 50 st to 100 st	Over 100 st to 200 st	Over 200 st		
32	93	110	130	152	71.5	22
40	93	110	130	152	78	22
50	104	125	145	172	83	23
63	104	125	145	172	88	23

(mm)

* Other dimensions are the same as standard products.

MGJ

MGP

MGQ

MGG

MGC

MGF

MGZ

MGT

D-□

-X□

Individual
-X□

Series MGP

Construction/Series MGPM

MGPM12 to 25

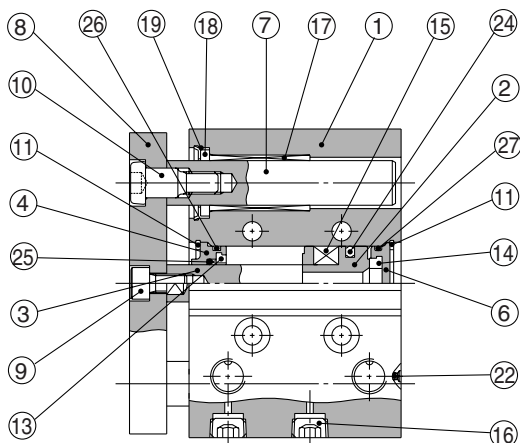

50 stroke or less

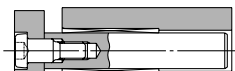

ø12, ø16 50 stroke or less

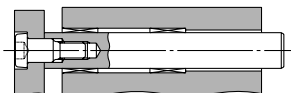

ø12, ø16 Over 50 stroke



ø20, ø25 Over 50 stroke

MGPM32 to 100

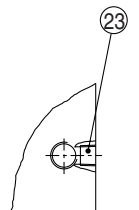
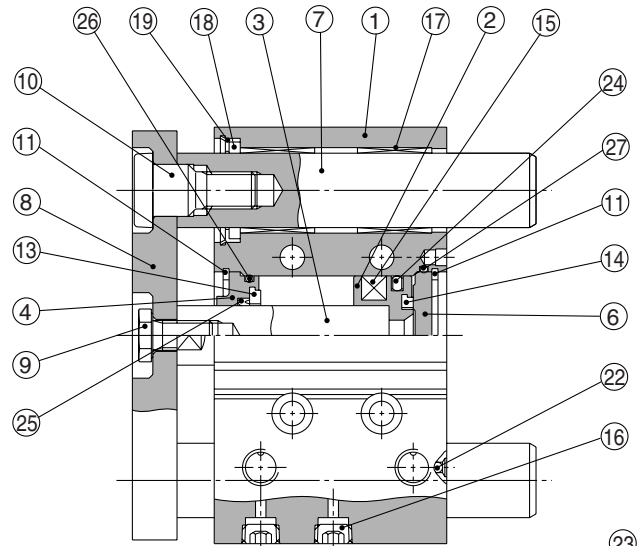

ø63 or more

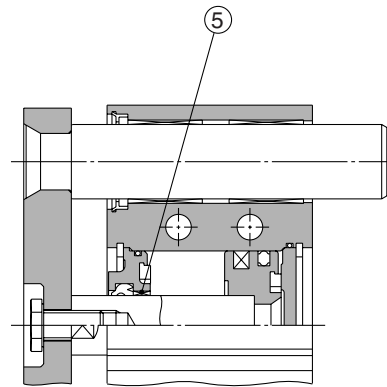

ø50 or more

Component Parts

No.	Description	Material	Note
1	Body	Aluminum alloy	Hard anodized
2	Piston	Aluminum alloy	Chromated
3	Piston rod	Stainless steel	ø12 to ø25
		Carbon steel	ø32 to ø100 Hard chrome plated
4	Collar	Aluminum bearing alloy	ø12 to ø40 Clear anodized
		Aluminum alloy casted	ø50 to ø100 Painted
5	Bushing	Babbitt	ø50 to ø100
6	Head cover	Aluminum alloy	ø12 to ø63 Chromated
			ø80 to ø100 Painted
7	Guide rod	Carbon steel	Hard chrome plated
8	Plate	Carbon steel	Nickel plated
9	Plate mounting bolt	Carbon steel	Nickel plated
10	Guide bolt	Carbon steel	Nickel plated
11	Retaining ring	Carbon tool steel	Phosphate coated
12	Retaining ring	Carbon tool steel	Phosphate coated
13	Bumper A	Urethane	
14	Bumper B	Urethane	
15	Magnet	-	
16	Plug Hexagon socket head cap plug	Carbon steel	ø12, ø16 Nickel plated
			ø20 to ø100
17	Slide Bearing	Babbitt	

Component Parts

No.	Description	Material	Note
18	Felt	Felt	
19	Holder	Resin	
20	Ball bushing		
21	Spacer	Aluminum alloy	
22	Steel ball	Carbon steel	ø12 to ø50
23	Plug	Carbon steel	ø63 to ø100 Nickel plated
24*	Piston seal	NBR	
25*	Rod seal	NBR	
26*	Gasket A	NBR	
27*	Gasket B	NBR	

Replacement Parts: Seal Kit

Bore size (mm)	Kit no.	Contents	Bore size (mm)	Kit no.	Contents
12	MGP12-PS	Set of nos. above ø12, ø16 ø20, ø25 ø29, ø27	40	MGP40-PS	Set of nos. above ø24, ø25 ø29, ø27
16	MGP16-PS		50	MGP50-PS	
20	MGP20-PS		63	MGP63-PS	
25	MGP25-PS		80	MGP80-PS	
32	MGP32-PS		100	MGP100-PS	

* Seal kit includes 24 to 27. Order the seal kit, based on each bore size.

* Since the seal kit does not include a grease pack, order it separately.
Grease pack part no.: GR-S-010 (10 g)

Construction/Series MGPL

MGPL12 to 25

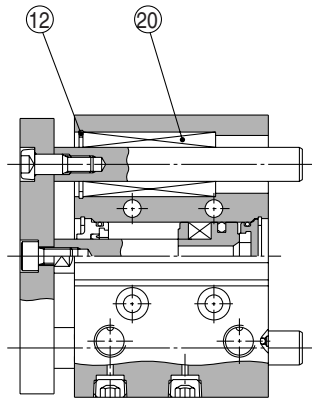

30 stroke or less

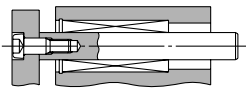

ø12, ø16 30 stroke or less

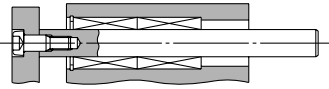

ø12, ø16 Over 30 stroke

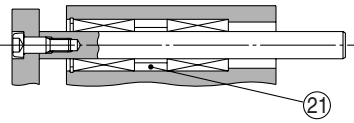

ø20, ø25 Over 100 stroke

MGPL32 to 100

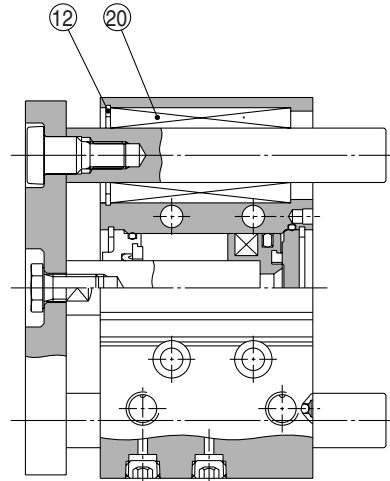

ø63 or more

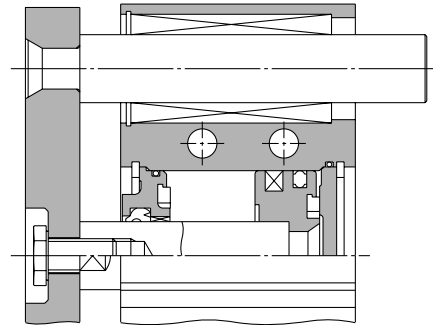

ø50 or more

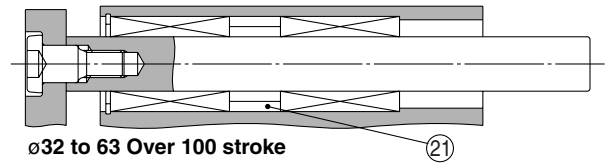

ø32 to 63 Over 100 stroke

MGJ

MGP

MGQ

MGG

MGC

MGF

MGZ

MGT

D-□

-X□

Individual
-X□

Series MGP

MGPM, MGPL: $\phi 12$ to $\phi 25$

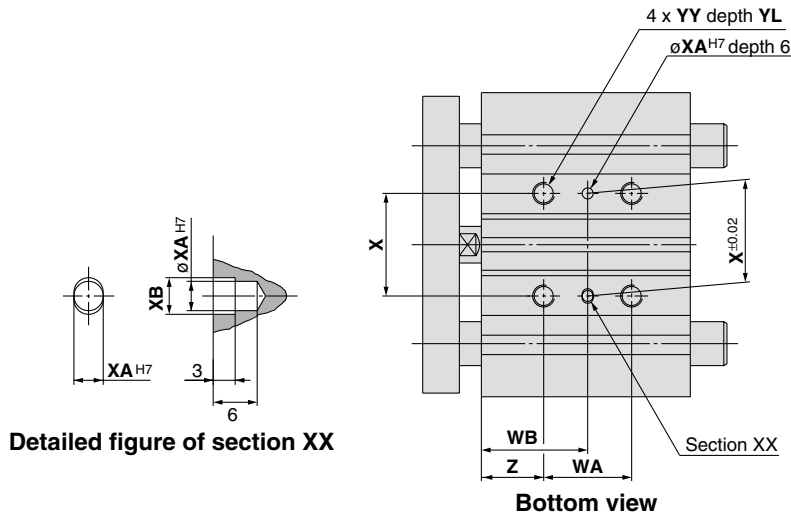

Detailed figure of section XX

Bottom view

T-slot dimensions

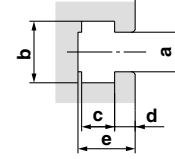

Bore size (mm)	T-slot dimensions (mm)				
	a	b	c	d	e
12	4.4	7.4	3.7	2	6.2
16	4.4	7.4	3.7	2.5	6.7
20	5.4	8.4	4.5	2.8	7.8
25	5.4	8.4	4.5	3	8.2

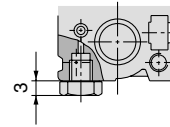

$\phi 12, \phi 16$

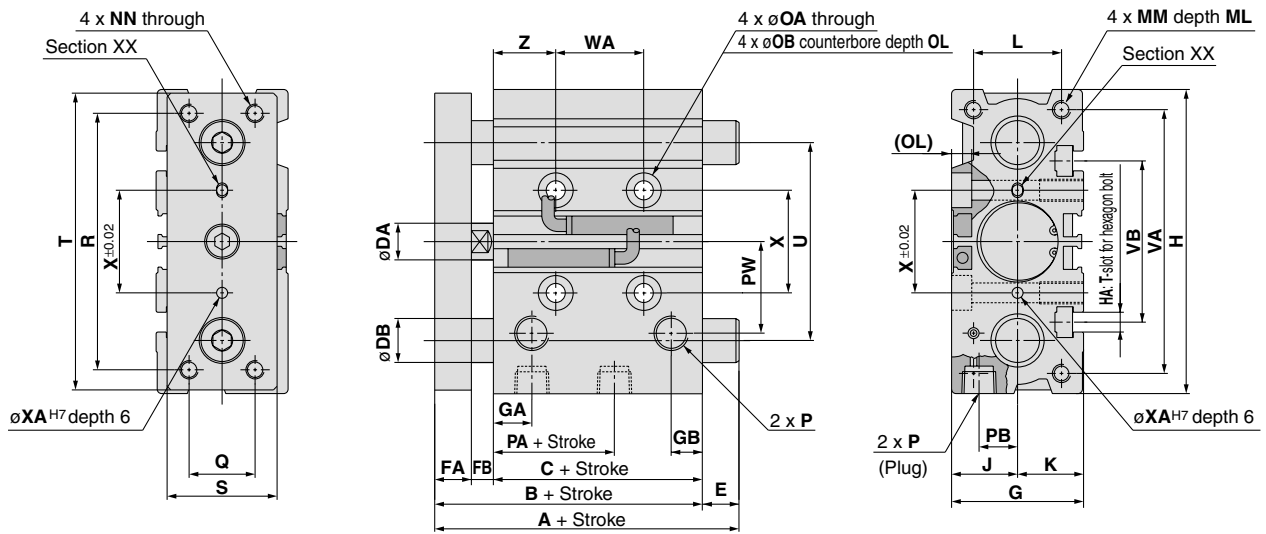

• For intermediate strokes other than standard strokes, refer to "Manufacture of Intermediate Stroke" on page 273.

• For bore sizes with $\phi 12$ and $\phi 16$ only, M5 x 0.8 is available.
• Rc, NPT, G port can be selected for bore sizes with $\phi 20$ or more. (Refer to page 272.)

MGPM, MGPL Common Dimensions

Bore size (mm)	Standard stroke (mm)	B	C	DA	FA	FB	G	GA	GB	H	HA	J	K	L	MM	ML	NN	OA	OB	OL	P		
																					Nil	N	TF
12	10, 20, 30, 40, 50, 75, 100	42	29	6	8	5	26	11	7.5	58	M4	13	13	18	M4 x 0.7	10	M4 x 0.7	4.3	8	4.5	M5 x 0.8	—	—
16	125, 150, 175, 200, 250	46	33	8	8	5	30	11	8	64	M4	15	15	22	M5 x 0.8	12	M5 x 0.8	4.3	8	4.5	M5 x 0.8	—	—
20	20, 30, 40, 50, 75, 100, 125, 150, 175, 200, 250, 300, 350, 400	53	37	10	10	6	36	10.5	8.5	83	M5	18	18	24	M5 x 0.8	13	M5 x 0.8	5.4	9.5	5.5	Rc 1/8	NPT 1/8	G 1/8
25		53.5	37.5	12	10	6	42	11.5	9	93	M5	21	21	30	M6 x 1.0	15	M6 x 1.0	5.4	9.5	5.5	Rc 1/8	NPT 1/8	G 1/8

Bore size (mm)	PA	PB	PW	Q	R	S	T	U	VA	VB	WA				WB				X	XA	XB	YY	YL	Z		
											30 st or less	Over 30 st to 100 st	Over 100 st to 200 st	Over 200 st to 300 st	Over 30 st to 100 st	Over 100 st to 200 st	Over 200 st to 300 st	Over 300 st								
12	13	8	18	14	48	22	56	41	50	37	20	40	110	200	—	15	25	60	105	—	23	3	3.5	M5 x 0.8	10	5
16	15	10	19	16	54	25	62	46	56	38	24	44	110	200	—	17	27	60	105	—	24	3	3.5	M5 x 0.8	10	5
20	12.5	10.5	25	18	70	30	81	54	72	44	24	44	120	200	300	29	39	77	117	167	28	3	3.5	M6 x 1.0	12	17
25	12.5	13.5	30	26	78	38	91	64	82	50	24	44	120	200	300	29	39	77	117	167	34	4	4.5	M6 x 1.0	12	17

MGPM (Slide bearing) A, DB, E Dimensions

Bore size (mm)	A				DB	E			
	50 st or less	Over 50 st to 100 st	Over 100 st to 200 st	Over 200 st		50 st or less	Over 50 st to 100 st	Over 100 st to 200 st	Over 200 st
12	42	60.5	85	85	8	0	18.5	43	43
16	46	64.5	95	95	10	0	18.5	49	49
20	53	84.5	84.5	122	12	0	31.5	31.5	69
25	53.5	85	85	122	16	0	31.5	31.5	68.5

MGPL (Ball bushing bearing) A, DB, E Dimensions

Bore size (mm)	A				DB	E			
	30 st or less	Over 30 st to 100 st	Over 100 st to 200 st	Over 200 st		30 st or less	Over 30 st to 100 st	Over 100 st to 200 st	Over 200 st
12	43	55	85	85	6	1	13	43	43
16	49	65	95	95	8	3	19	49	49
20	63	80	104	122	10	10	27	51	69
25	69.5	85.5	104.5	122	13	16	32	51	68.5

MGPM, MGPL: $\phi 32$ to $\phi 63$

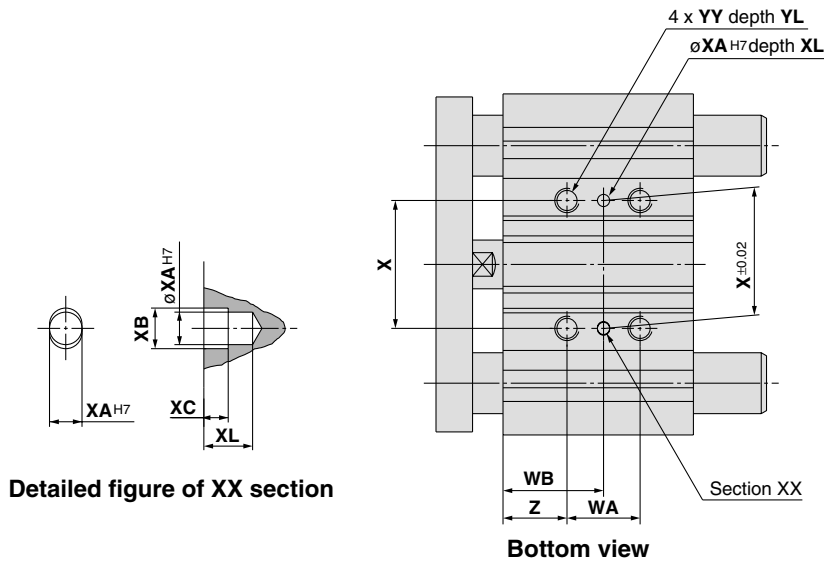

T-slot dimensions

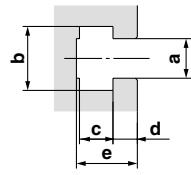

Bore size (mm)	T-slot dimensions (mm)				
	a	b	c	d	e
32	6.5	10.5	5.5	3.5	9.5
40	6.5	10.5	5.5	4	11
50	8.5	13.5	7.5	4.5	13.5
63	11	17.8	10	7	18.5

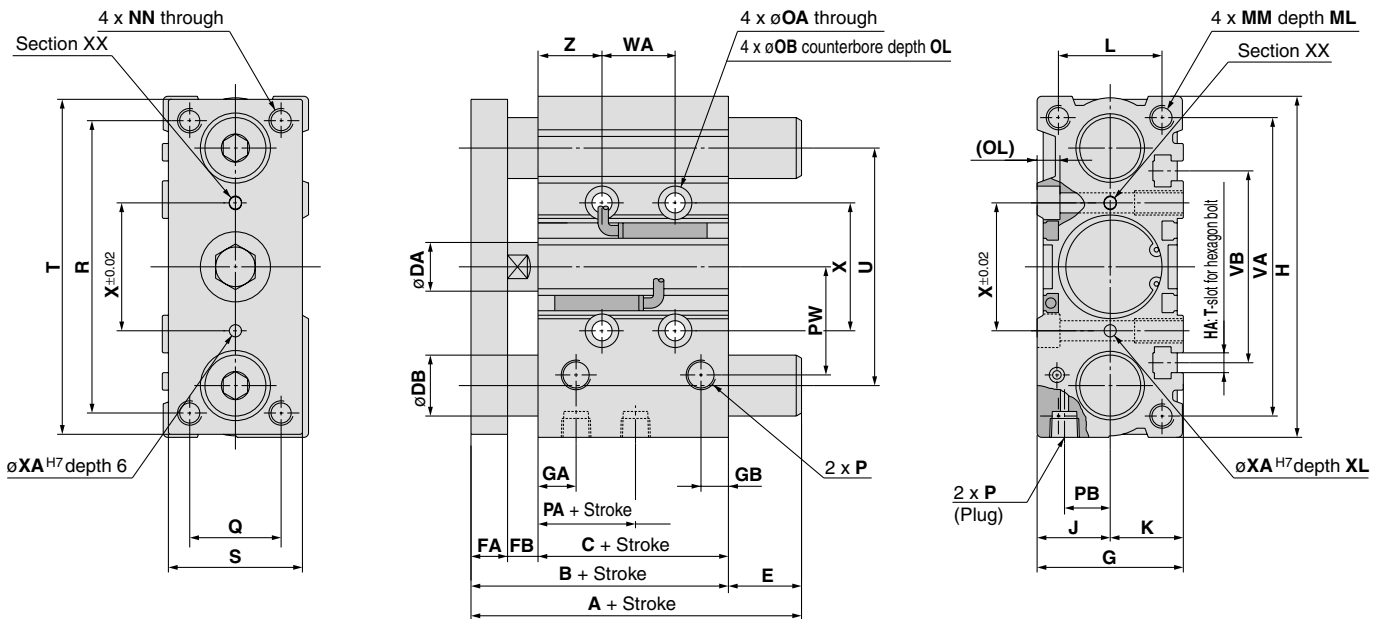

- MGJ
- MGP**
- MGQ
- MGG
- MGC
- MGF
- MGZ
- MGT

• For intermediate strokes other than standard strokes, refer to "Manufacture of Intermediate Stroke" on page 273.

• Choice of Rc, NPT, G port is possible. (Refer to page 272.)

MGPM, MGPL Common Dimensions (mm)

Bore size (mm)	Standard stroke (mm)	B	C	DA	FA	FB	G	GA	GB	H	HA	J	K	L	MM	ML	NN	OA	OB	OL	P		
																					Nil	N	TF
32	25, 50, 75	59.5	37.5	16	12	10	48	12.5	9	112	M6	24	24	34	M8 x 1.25	20	M8 x 1.25	6.6	11	7.5	Rc 1/8	NPT 1/8	G 1/8
40	100, 125, 150	66	44	16	12	10	54	14	10	120	M6	27	27	40	M8 x 1.25	20	M8 x 1.25	6.6	11	7.5	Rc 1/8	NPT 1/8	G 1/8
50	175, 200, 250	72	44	20	16	12	64	14	11	148	M8	32	32	46	M10 x 1.5	22	M10 x 1.5	8.6	14	9	Rc 1/4	NPT 1/4	G 1/4
63	300, 350, 400	77	49	20	16	12	78	16.5	13.5	162	M10	39	39	58	M10 x 1.5	22	M10 x 1.5	8.6	14	9	Rc 1/4	NPT 1/4	G 1/4

Bore size (mm)	PA	PB	PW	Q	R	S	T	U	VA	VB	WA					WB					X	XA	XB	XC	XL	YY	YL	Z
											25 st or less	Over 25 st to 100 st	Over 100 st to 200 st	Over 200 st to 300 st	Over 300 st	25 st or less	Over 25 st to 100 st	Over 100 st to 200 st	Over 200 st to 300 st	Over 300 st								
32	7	15	35.5	30	96	44	110	78	98	63	24	48	124	200	300	33	45	83	121	171	42	4	4.5	3	6	M8 x 1.25	16	21
40	13	18	39.5	30	104	44	118	86	106	72	24	48	124	200	300	34	46	84	122	172	50	4	4.5	3	6	M8 x 1.25	16	22
50	9	21.5	47	40	130	60	146	110	130	92	24	48	124	200	300	36	48	86	124	174	66	5	6	4	8	M10 x 1.5	20	24
63	14	28	58	50	130	70	158	124	142	110	28	52	128	200	300	38	50	88	124	174	80	5	6	4	8	M10 x 1.5	20	24

MGPM (Slide bearing) A, DB, E Dimensions (mm)

Bore size (mm)	A			DB	E		
	50 st or less	Over 50 st to 200 st	Over 200 st		50 st or less	Over 50 st to 200 st	Over 200 st
32	97	102	140	20	37.5	42.5	80.5
40	97	102	140	20	31	36	74
50	106.5	118	161	25	34.5	46	89
63	106.5	118	161	25	29.5	41	84

MGPL (Ball bushing bearing) A, DB, E Dimensions (mm)

Bore size (mm)	A				DB	E			
	50 st or less	Over 50 st to 100 st	Over 100 st to 200 st	Over 200 st		50 st or less	Over 50 st to 100 st	Over 100 st to 200 st	Over 200 st
32	81	98	118	140	16	21.5	38.5	58.5	80.5
40	81	98	118	140	16	15	32	52	74
50	93	114	134	161	20	21	42	62	89
63	93	114	134	161	20	16	37	57	84

- D-
- X
- Individual -X

Series MGP

MGPM, MGPL: $\phi 80, \phi 100$

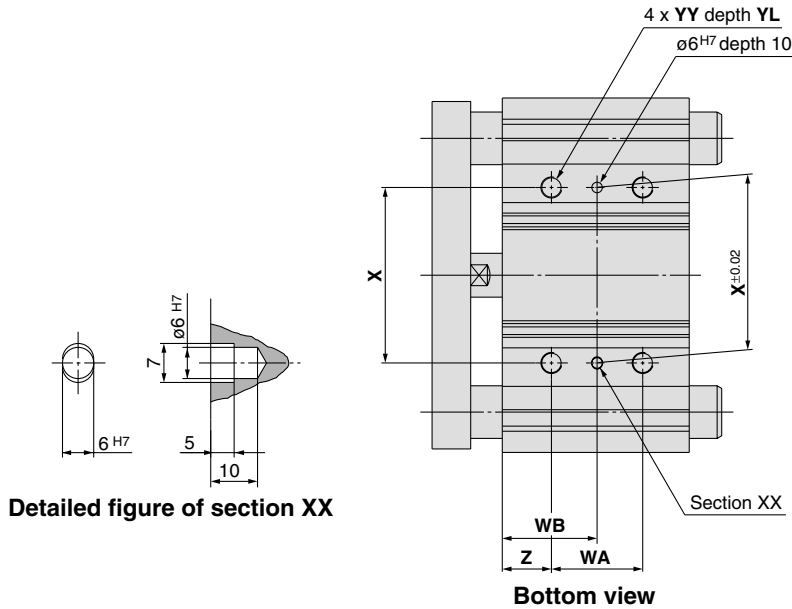

T-slot dimensions

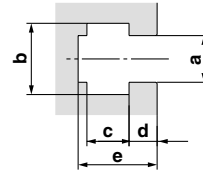

Bore size (mm)	T-slot dimensions				
	a	b	c	d	e
80	13.3	20.3	12	8	22.5
100	15.3	23.3	13.5	10	30

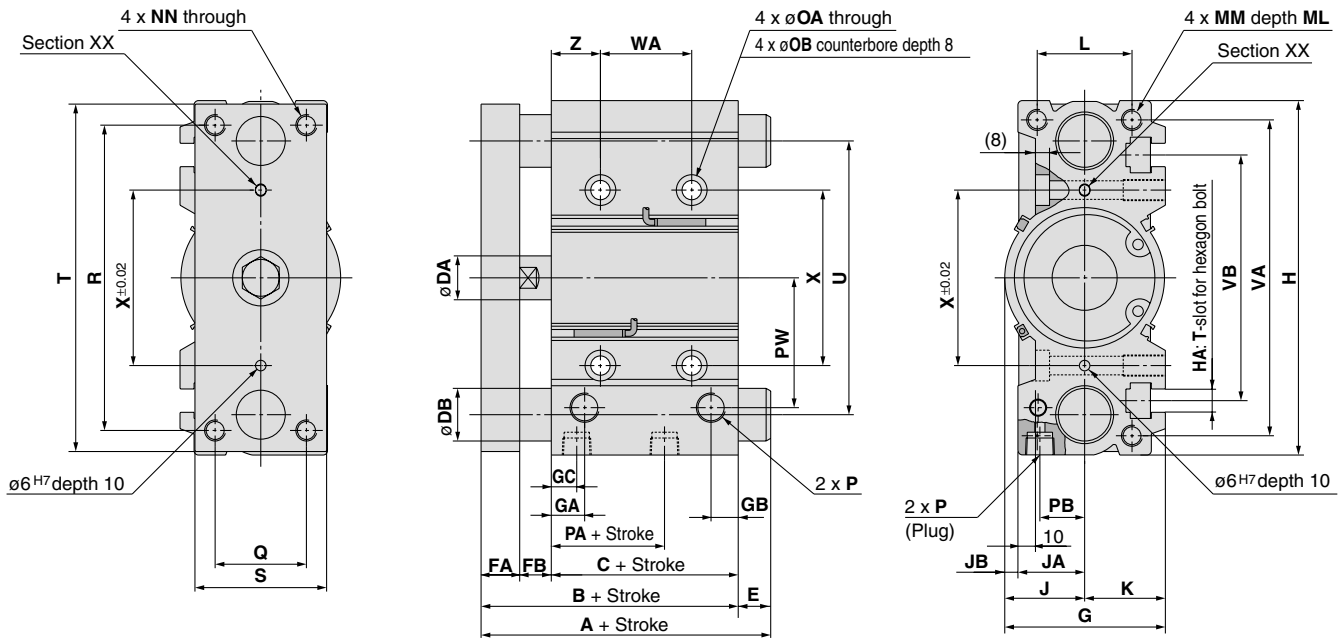

• For intermediate strokes other than standard strokes, refer to "Manufacture of Intermediate Stroke" on page 273.

• Choice of Rc, NPT, G port is possible. (Refer to page 272.)

MGPM, MGPL Common Dimensions

Bore size (mm)	Standard stroke (mm)	B	C	DA	FA	FB	G	GA	GB	GC	H	HA	J	JA	JB	K	L	MM	ML	NN	OA	OB	P		
																							Nil	N	TF
80	25, 50, 75, 100	96.5	56.5	25	22	18	91.5	19	15.5	14.5	202	M12	45.5	38	7.5	46	54	M12 x 1.75	25	M12 x 1.75	10.6	17.5	Rc 3/8	NPT 3/8	G 3/8
100	125, 150, 175, 200	116	66	30	25	25	111.5	23	19	18	240	M14	55.5	45	10.5	56	62	M14 x 2.0	31	M14 x 2.0	12.5	20	Rc 3/8	NPT 3/8	G 3/8

Bore size (mm)	PA	PB	PW	Q	R	S	T	U	VA	VB	WA					WB					X	YY	YL	Z
											25 st or less	Over 25 st to 100 st	Over 100 st to 200 st	Over 200 st to 300 st	Over 300 st	25 st or less	Over 25 st to 100 st	Over 100 st to 200 st	Over 200 st to 300 st	Over 300 st				
80	14.5	25.5	74	52	174	75	198	156	180	140	28	52	128	200	300	42	54	92	128	178	100	M12 x 1.75	24	28
100	17.5	32.5	89	64	210	90	236	188	210	166	48	72	148	220	320	35	47	85	121	171	124	M14 x 2.0	28	11

MGPM (Slide bearing) A, DB, E Dimensions

Bore size (mm)	A			DB	E		
	50 st or less	Over 50 st to 200 st	Over 200 st		50 st or less	Over 50 st to 200 st	Over 200 st
80	115	142	193	30	18.5	45.5	96.5
100	137	162	203	36	21	46	87

MGPL (Ball bushing bearing) A, DB, E Dimensions

Bore size (mm)	A				DB	E			
	25 st or less	Over 25 st to 50 st	Over 50 st to 200 st	Over 200 st		25 st or less	Over 25 st to 50 st	Over 50 st to 200 st	Over 200 st
80	109.5	130	160	193	25	13	33.5	63.5	96.5
100	121	147	180	203	30	5	31	64	87

Compact Guide Cylinder/With Air Cushion

Series *MGP*

Ø16, Ø20, Ø25, Ø32, Ø40, Ø50, Ø63, Ø80, Ø100



MGJ

MGP

MGQ

MGG

MGK

MGF

MGZ

MGT

Stroke Variations

Bearing type	Bore size (mm)	Stroke (mm)													Intermediate stroke		
		25	50	75	100	125	150	175	200	250	300	350	400				
MGPM Slide bearing	16	●	●	●	●	●	●	●	●	●	●	●	●	●	●	●	Strokes available by the 1 mm interval by changing the collar.
	20	●	●	●	●	●	●	●	●	●	●	●	●	●	●	●	
	25	●	●	●	●	●	●	●	●	●	●	●	●	●	●	●	
	32	●	●	●	●	●	●	●	●	●	●	●	●	●	●	●	
MGPL Ball bushing bearing	40	●	●	●	●	●	●	●	●	●	●	●	●	●	●	●	
	50	●	●	●	●	●	●	●	●	●	●	●	●	●	●	●	
	63	●	●	●	●	●	●	●	●	●	●	●	●	●	●	●	
	80	●	●	●	●	●	●	●	●	●	●	●	●	●	●	●	
	100	●	●	●	●	●	●	●	●	●	●	●	●	●	●	●	

D-□

-X□

Individual
-X□

Compact Guide Cylinder/With Air Cushion Series MGP

ø16, ø20, ø25, ø32, ø40, ø50, ø63, ø80, ø100

How to Order

Compact Guide Cylinder **MGP** **M** **32** **50** **A** **M9BW** **2** **—**

Compact Guide Cylinder

Bearing type

M	Slide bearing
L	Ball bushing bearing

Bore size

16	16 mm	50	50 mm
20	20 mm	63	63 mm
25	25 mm	80	80 mm
32	32 mm	100	100 mm
40	40 mm		

Thread type

Nil	M5 x 0.8
	Rc
N	NPT
TF	G

* For bore sizes 16, M5 x 0.8 is only available.

Auto switch

Nil	Without auto switch (Built-in magnet)
------------	---------------------------------------

* For the applicable auto switch model, refer to the table below.

Number of auto switches

Nil	2 pcs.
S	1 pc.
n	n pcs.

Made to Order Specification
For details, refer to page 291.

With air cushion

Cylinder stroke (mm)
Refer to "Standard Stroke" on page 291.

Applicable Auto Switch/Refer to pages 1719 to 1827 for further information on auto switches.

Type	Special function	Electrical entry	Indicator light	Wiring (Output)	Load voltage		Auto switch model		Lead wire length (m)				Pre-wired connector	Applicable load				
					DC	AC	Perpendicular	In-line	0.5 (Nil)	1 (M)	3 (L)	5 (Z)		IC circuit	Relay, PLC			
Solid state switch	—	Grommet	Yes	3-wire (NPN)	5V, 12V	—	—	M9NV	M9N	●	●	●	○	○	IC circuit	Relay, PLC		
				3-wire (PNP)				M9PV	M9P	●	●	●	○	○				
				2-wire	12V			M9BV	M9B	●	●	●	○	○	○		○	IC circuit
				3-wire (NPN)	5V, 12V			M9NWV	M9NW	●	●	●	○	○	○			
	3-wire (PNP)			M9PWV				M9PW	●	●	●	○	○	○				
	2-wire			12V	M9BWV			M9BW	●	●	●	○	○	○	○		○	
	3-wire (NPN)			5V, 12V	M9NAV			M9NA	○	○	●	○	○	○	○		IC circuit	
	3-wire (PNP)				M9PAV			M9PA	○	○	●	○	○	○				
	2-wire			12V	M9BAV			M9BA	○	○	○	●	○	○	○		○	
	2-wire (Non-polar)			—	—			P4DW	—	—	●	●	○	○	○		○	
Reed switch	—	Grommet	Yes	3-wire (NPN equivalent)	—	5V	—	A96V	A96	●	—	●	—	—	IC circuit	—		
				2-wire	24V	12V	100V	A93V	A93	●	—	●	—	—	—	—	Relay, PLC	
						100V or less	A90V	A90	●	—	●	—	—	—	—	IC circuit		

* Lead wire length symbols: 0.5 m..... Nil (Example) M9NW
 1 m..... M (Example) M9NWM
 3 m..... L (Example) M9NWL
 5 m..... Z (Example) M9NWX

* Solid state auto switches marked with "○" are produced upon receipt of order.
 * D-P4DW type can be mounted on bore sizes ø32 to ø100.

* Since there are other applicable auto switches than listed, refer to page 336 for details.
 * For details about auto switches with pre-wired connector, refer to pages 1784 and 1785.
 * Auto switches are shipped together (not assembled).

Series MGP

Mass

Slide bearing: MGPM16 to 100

(kg)

Bore size (mm)	Model	Standard stroke (mm)											
		25	50	75	100	125	150	175	200	250	300	350	400
16	MGPM16	0.51	0.69	0.78	0.91	1.07	1.20	1.32	1.45	1.70	—	—	—
20	MGPM20	0.89	1.14	1.34	1.54	1.74	1.94	2.13	2.33	2.80	3.20	3.59	3.99
25	MGPM25	1.23	1.60	1.87	2.14	2.41	2.68	2.95	3.23	3.89	4.43	4.97	5.51
32	MGPM32	1.98	2.51	2.77	3.15	3.53	3.91	4.29	4.68	5.63	6.39	7.15	7.92
40	MGPM40	2.34	2.91	3.21	3.64	4.06	4.49	4.92	5.34	6.38	7.23	8.09	8.94
50	MGPM50	3.92	4.75	5.29	5.93	6.57	7.21	7.85	8.49	10.1	11.4	12.7	13.9
63	MGPM63	4.94	5.89	6.54	7.29	8.05	8.81	9.56	10.3	12.2	13.7	15.2	16.7
80	MGPM80	—	8.98	9.64	10.6	11.5	12.5	13.4	14.3	16.8	18.7	20.5	22.4
100	MGPM100	—	14.2	15.1	16.5	17.8	19.1	20.5	21.8	25.1	27.8	30.4	33.1

Ball bushing bearing: MGPL16 to 100

(kg)

Bore size (mm)	Model	Standard stroke (mm)											
		25	50	75	100	125	150	175	200	250	300	350	400
16	MGPL16	0.56	0.66	0.78	0.89	1.03	1.15	1.26	1.38	1.61	—	—	—
20	MGPL20	0.97	1.12	1.30	1.47	1.68	1.85	2.03	2.20	2.57	2.92	3.27	3.62
25	MGPL25	1.34	1.54	1.78	1.96	2.19	2.46	2.69	2.92	3.33	3.83	4.30	4.76
32	MGPL32	1.81	2.34	2.57	2.88	3.26	3.58	3.89	4.21	4.91	5.54	6.17	6.80
40	MGPL40	2.15	2.73	3.01	3.36	3.78	4.14	4.50	4.86	5.65	6.37	7.08	7.80
50	MGPL50	3.65	4.47	4.95	5.49	6.14	6.69	7.24	7.79	9.02	10.1	11.2	12.3
63	MGPL63	4.66	5.60	6.20	6.85	7.61	8.28	8.95	9.61	11.1	12.4	13.7	15.1
80	MGPL80	—	8.88	9.63	10.5	11.3	12.1	12.9	13.7	15.6	17.3	18.9	20.5
100	MGPL100	—	13.7	14.9	16.1	17.2	18.4	19.6	20.8	23.4	25.7	28.1	30.4

Allowable Rotational Torque of Plate (Air Cushion)

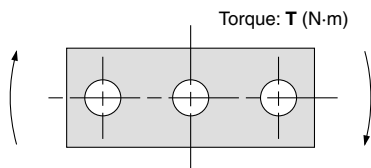

T (N · m)

Bore size (mm)	Bearing type	Stroke											
		25	50	75	100	125	150	175	200	250	300	350	400
16	MGPM	0.53	0.84	0.69	0.58	0.50	0.44	0.40	0.36	0.30	—	—	—
	MGPL	1.27	0.86	0.65	0.52	0.43	0.37	0.32	0.28	0.23	—	—	—
20	MGPM	0.99	2.23	1.88	1.63	1.44	1.28	1.16	1.06	0.90	0.78	0.69	0.62
	MGPL	2.66	1.94	1.52	1.57	1.34	1.17	1.03	0.93	0.76	0.65	0.56	0.49
25	MGPM	1.64	3.51	2.96	2.57	2.26	2.02	1.83	1.67	1.42	1.24	1.09	0.98
	MGPL	4.08	3.02	2.38	2.41	2.05	1.78	1.58	1.41	1.16	0.98	0.85	0.74
32	MGPM	6.35	6.64	5.69	4.97	4.42	3.98	3.61	3.31	2.84	2.48	2.20	1.98
	MGPL	5.95	5.89	5.11	6.99	6.34	5.79	5.33	4.93	4.29	3.78	3.38	3.04
40	MGPM	7.00	7.32	6.27	5.48	4.87	4.38	3.98	3.65	3.13	2.74	2.43	2.19
	MGPL	6.55	6.49	5.62	7.70	6.98	6.38	5.87	5.43	4.72	4.16	3.71	3.35
50	MGPM	13.0	13.8	12.0	10.6	9.50	8.60	7.86	7.24	6.24	5.49	4.90	4.43
	MGPL	9.17	11.2	9.80	12.8	11.6	10.7	9.80	9.10	7.95	7.02	6.26	5.63
63	MGPM	14.7	15.6	13.5	11.9	10.7	9.69	8.86	8.16	7.04	6.19	5.52	4.99
	MGPL	10.2	12.5	11.0	14.3	13.0	11.9	11.0	10.2	8.84	7.80	6.64	6.24
80	MGPM	—	26.0	22.9	20.5	18.6	17.0	15.6	14.5	12.6	11.2	10.0	9.11
	MGPL	—	25.2	22.7	20.6	18.9	17.3	16.0	14.8	12.9	11.3	10.0	8.94
100	MGPM	—	41.9	37.5	33.8	30.9	28.4	26.2	24.4	21.4	19.1	17.2	15.7
	MGPL	—	41.7	37.9	34.6	31.8	29.3	27.2	25.3	22.1	19.5	17.3	15.5

Non-rotating Accuracy of Plate

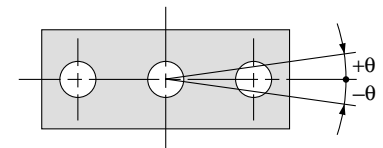

For non-rotating accuracy θ without load, use a value no more than the values in the table as a guide.

Bore size (mm)	Non-rotating accuracy θ	
	MGPM	MGPL
16	$\pm 0.08^\circ$	$\pm 0.10^\circ$
20	$\pm 0.07^\circ$	$\pm 0.09^\circ$
25		
32	$\pm 0.06^\circ$	$\pm 0.08^\circ$
40		
50	$\pm 0.05^\circ$	$\pm 0.06^\circ$
63		
80	$\pm 0.04^\circ$	$\pm 0.05^\circ$
100		

Compact Guide Cylinder/With Air Cushion Series MGP Model Selection

Selection Conditions

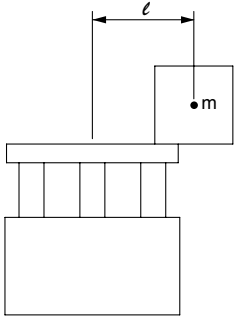
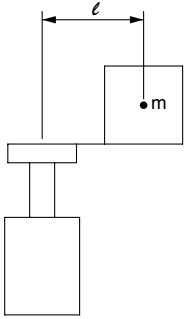
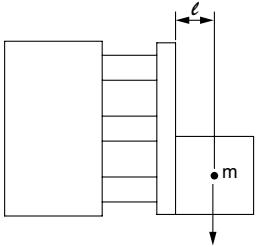
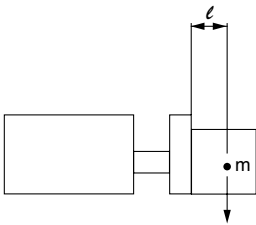
Mounting orientation	Vertical		Horizontal	
				
Maximum speed (mm/s)	200 or less	400	200 or less	400
Graph (Slide bearing type)	(1), (2)	(3), (4)	(15), (16)	(17), (18)
Graph (Ball bushing bearing type)	(5) to (9)	(10) to (14)	(19), (20)	(21), (22)

Selection Example 1 (Vertical Mounting)

Selection conditions

Mounting: Vertical
Bearing type: Ball bushing
Stroke: 75 stroke
Maximum speed: 200 mm/s
Load mass: 7 kg
Eccentric distance: 70 mm

Find the point of intersection for the load mass of 7 kg and the eccentric distance of 70 mm on graph (5), based on vertical mounting, ball bushing, 75 mm stroke, and the speed of 200 mm/s.
→ MGPL25-75A is selected.

(5) 75 Stroke or Less, $V = 200$ mm/s or less

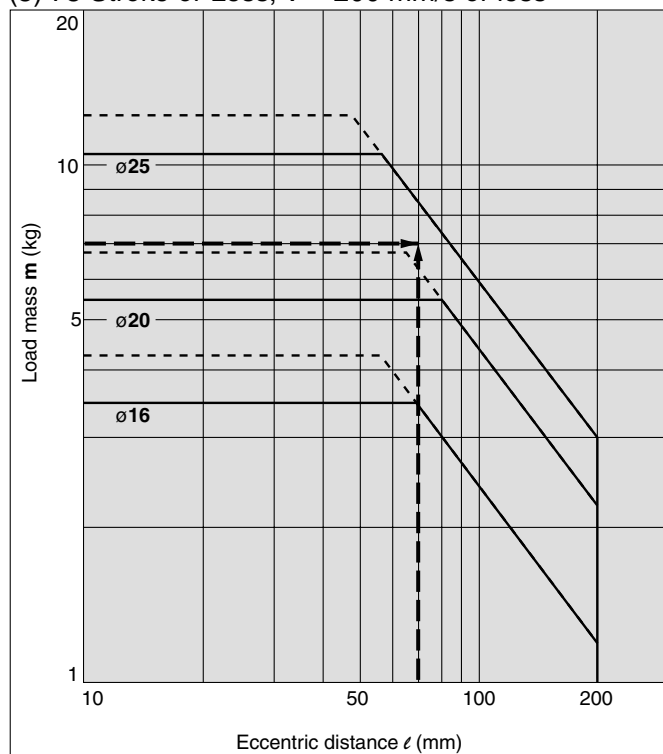

Selection Example 2 (Horizontal Mounting)

Selection conditions

Mounting: Horizontal
Bearing type: Slide bearing
Distance between plate and load center of gravity: 40 mm
Maximum speed: 400 mm/s
Load mass: 8 kg
Stroke: 100 stroke

Find the point of intersection for the load mass of 8 kg and 100 stroke on graph (17), based on horizontal mounting, slide bearing, the distance of 40 mm between the plate and load center of gravity, and the speed of 400 mm/s.
→ MGPM32-100A is selected.

(17) $l = 50$ mm, $V = 400$ mm/s

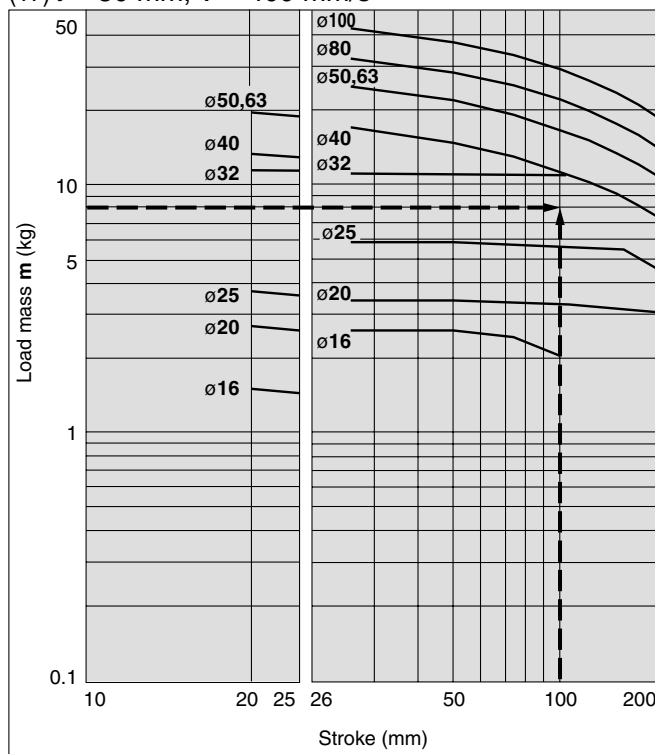

· When the maximum speed exceeds 200 mm/s, the allowable load mass is determined by multiplying the value shown in the graph at 400 mm/s by the coefficient listed in the table below.

Maximum	Up to 300 mm/s	Up to 400 mm/s	Up to 500 mm/s
Coefficient	1.7	1	0.6

MGJ

MGP

MGQ

MGG

MGC

MGF

MGZ

MGT

D-□

-X□

Individual
-X□

Series MGP

Vertical Mounting (Slide Bearing)

— Operating pressure 0.4 MPa
 - - - Operating pressure 0.5 MPa or more

MGPM16 to 100

(1) 25 Stroke, V = 200 mm/s or less

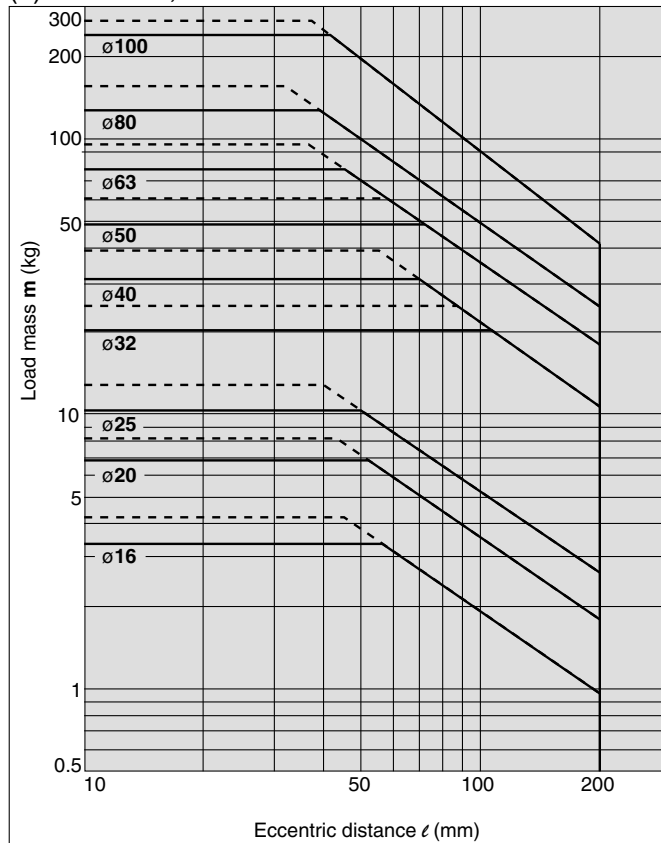

(2) Over 25 Stroke, V = 200 mm/s or less

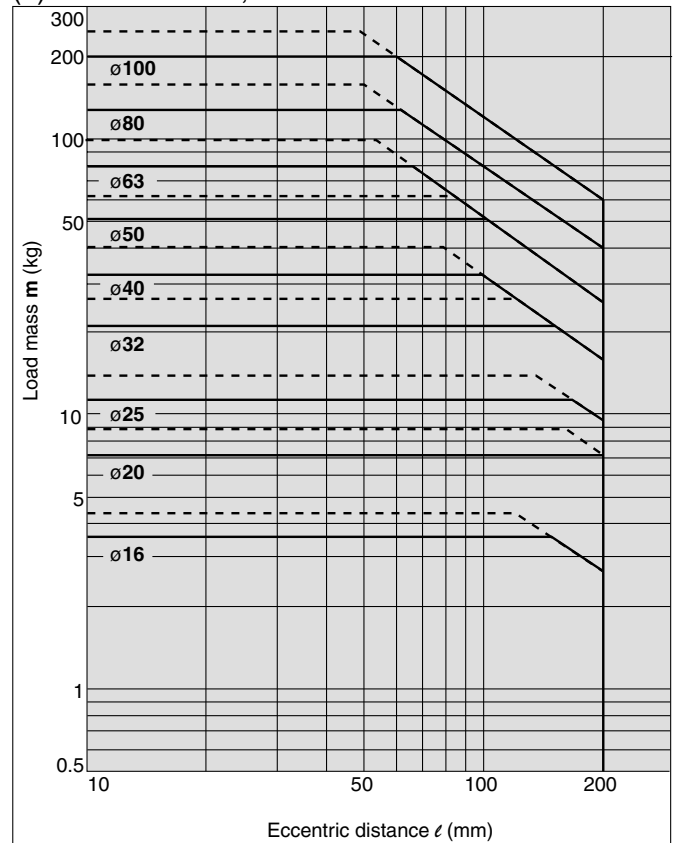

(3) 25 Stroke, V = 400 mm/s

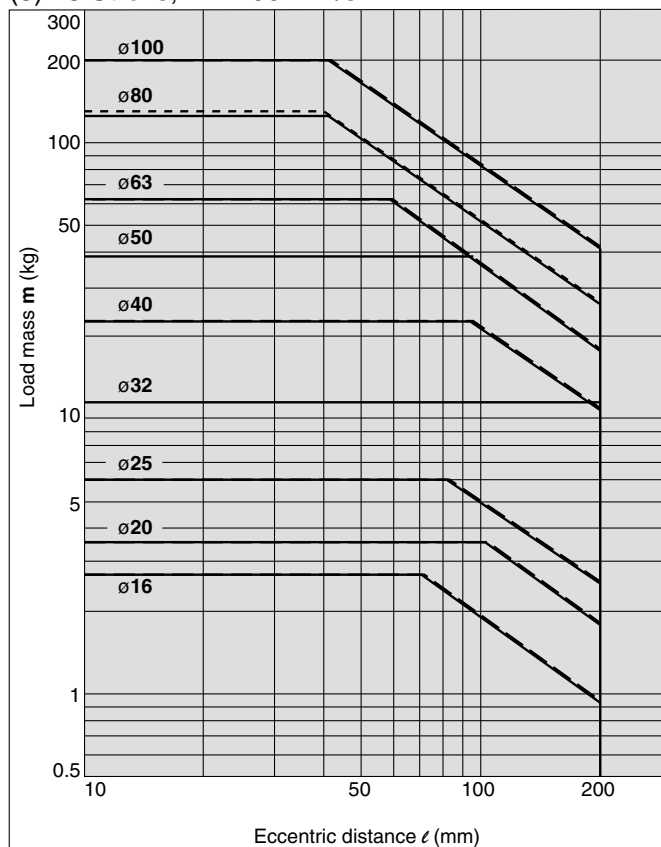

(4) Over 25 Stroke, V = 400 mm/s

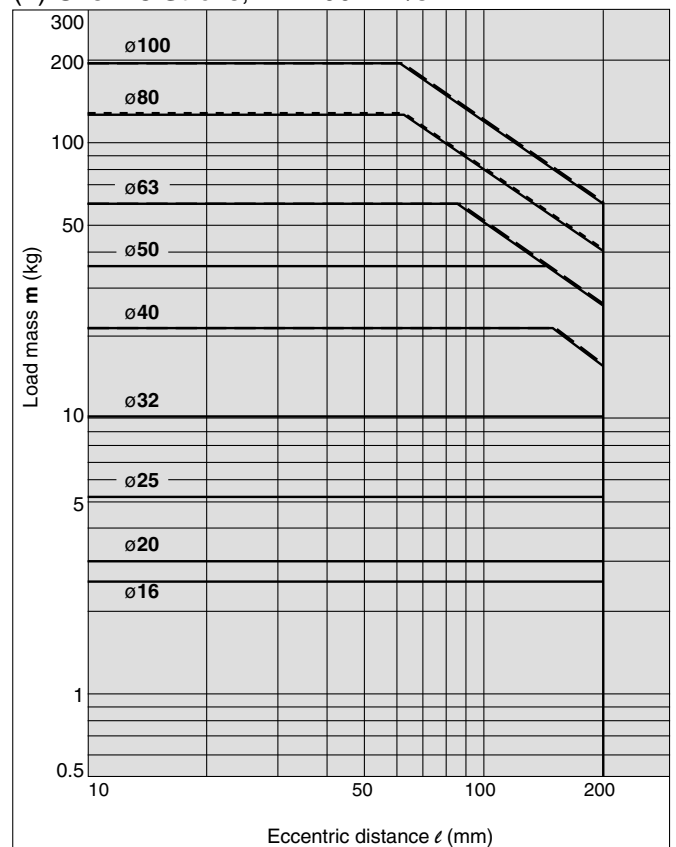

— Operating pressure 0.4 MPa
- - - Operating pressure 0.5 MPa or more

Vertical Mounting (Ball Bushing)

MGPL16 to 25

(5) 75 Stroke or Less, $V = 200$ mm/s or less

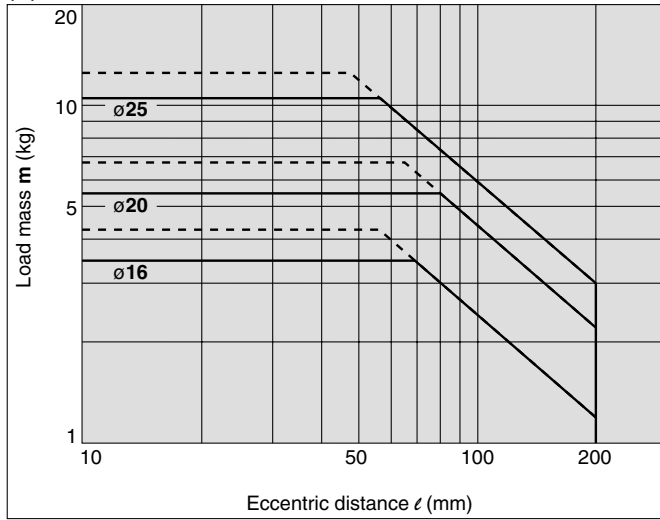

(6) Over 75 Stroke, $V = 200$ mm/s or less

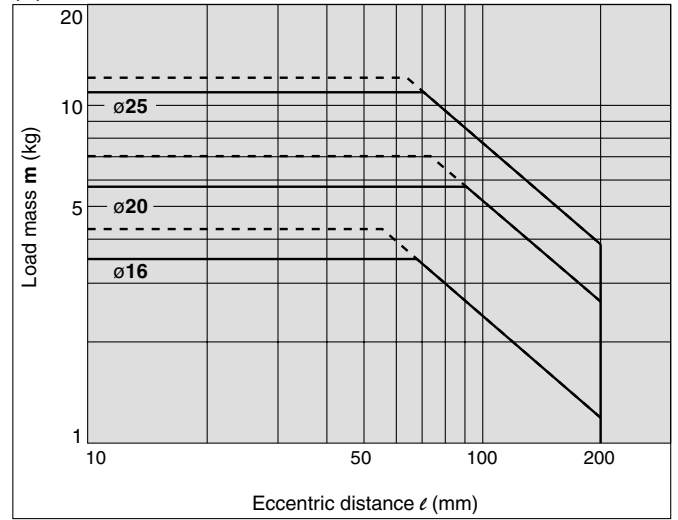

MGPL32 to 63

(7) 25 Stroke, $V = 200$ mm/s or less

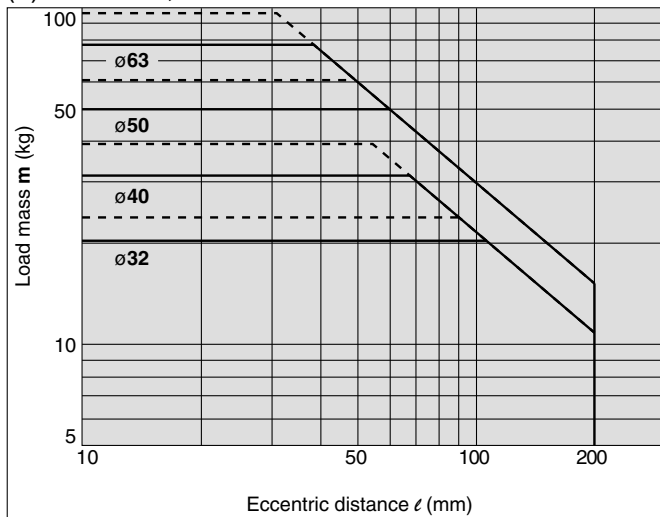

(8) Over 25 Stroke, $V = 200$ mm/s or less

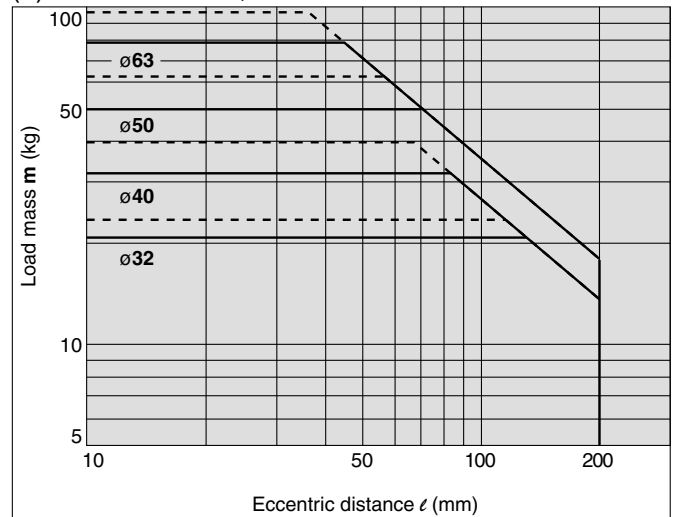

MGPL80, 100

(7) $V = 200$ mm/s or less

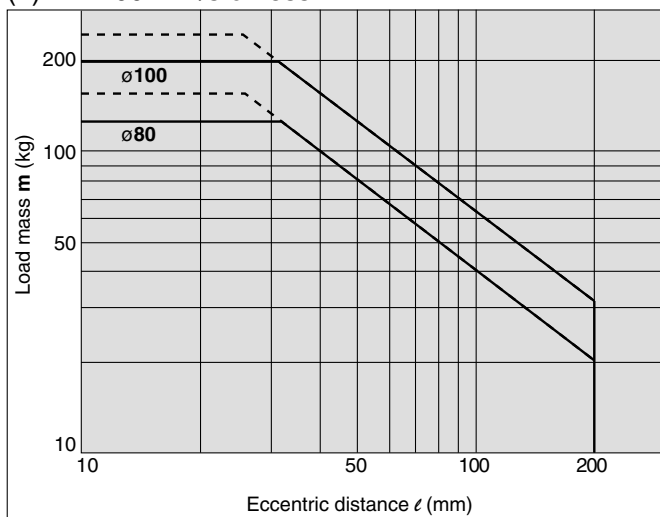

- MGJ
- MGP**
- MGQ
- MGG
- MGC
- MGF
- MGZ
- MGT

- D-□
- X□
- Individual
- X□

Series MGP

Vertical Mounting (Ball Bushing)

Operating pressure 0.4 MPa

MGPL16 to 25

(10) 75 Stroke or Less, V = 400 mm/s

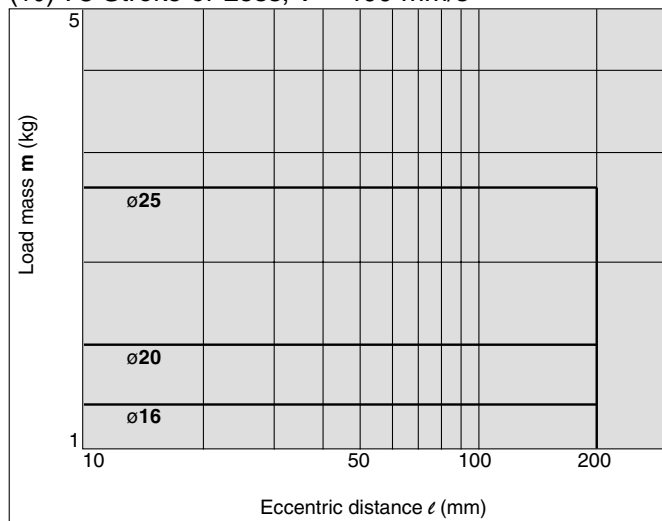

(11) Over 75 Stroke, V = 400 mm/s

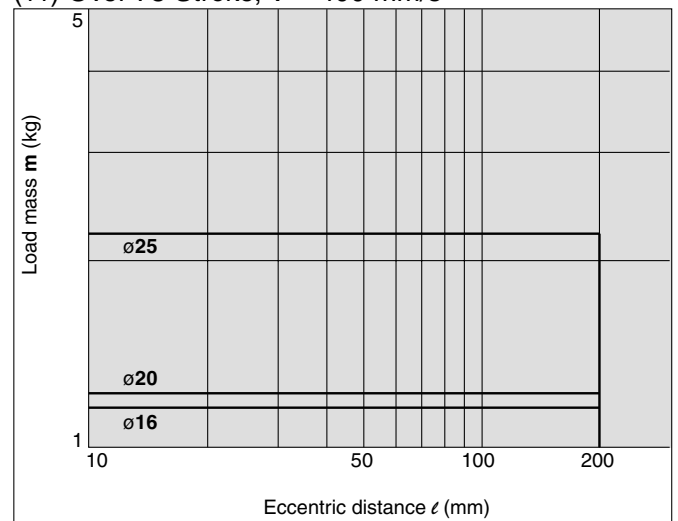

MGPL32 to 63

(12) 25 Stroke, V = 400 mm/s

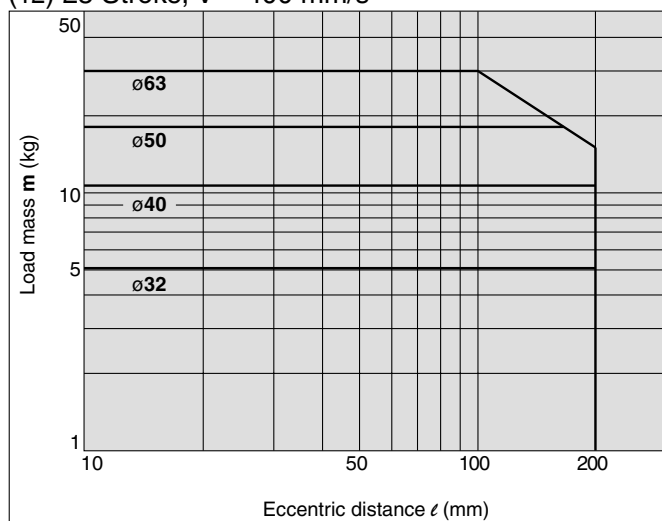

(13) Over 25 Stroke, V = 400 mm/s

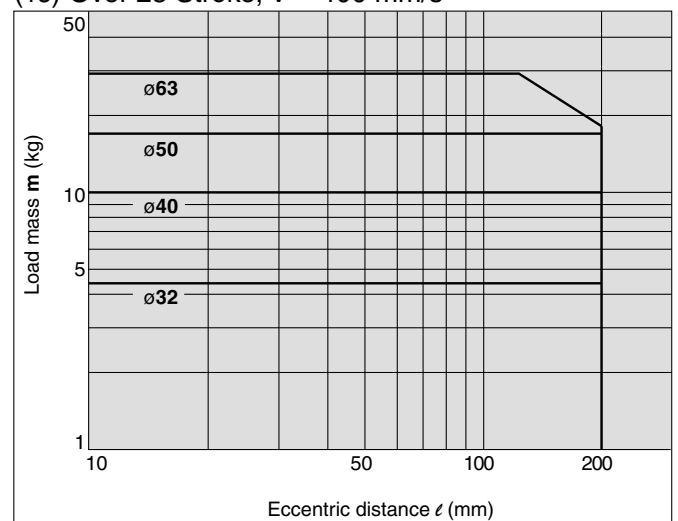

MGPL80, 100

(14) V = 400 mm/s

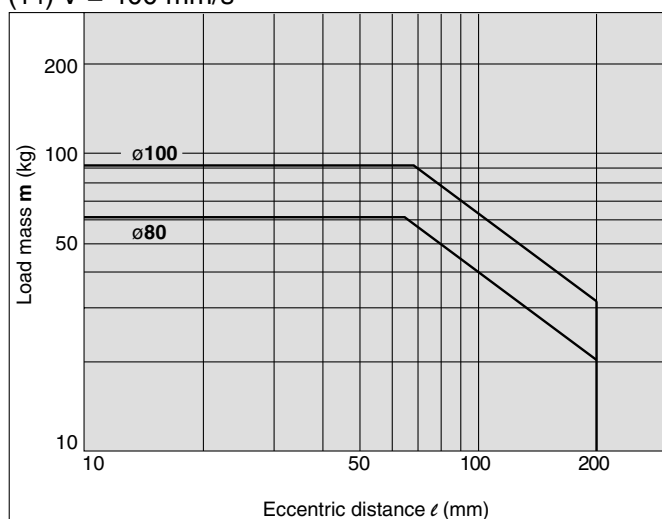

Horizontal Mounting (Slide Bearing)

MGPM16 to 100

(15) $\ell = 50$ mm, $V = 200$ mm/s or less

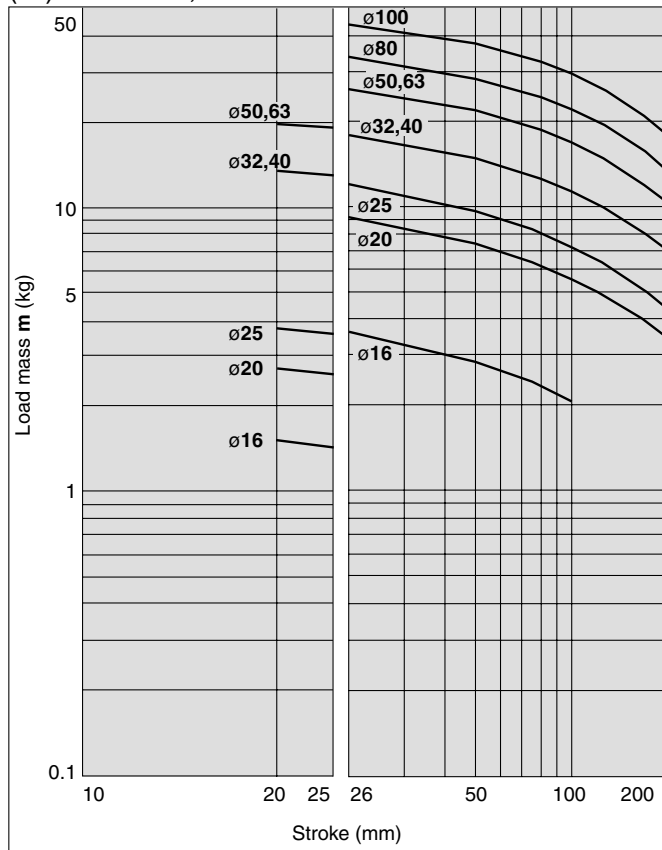

(16) $\ell = 100$ mm, $V = 200$ mm/s or less

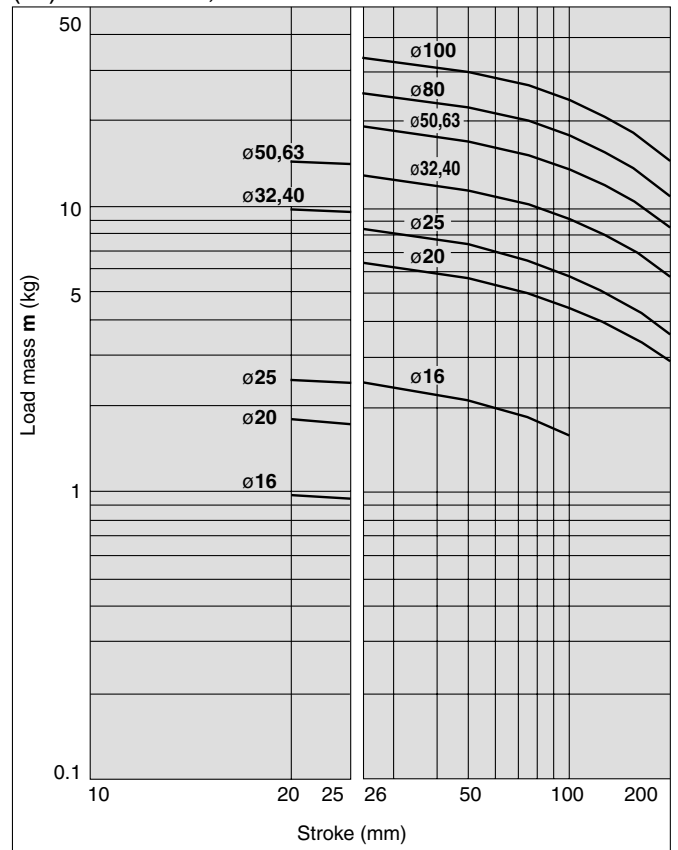

(17) $\ell = 50$ mm, $V = 400$ mm/s

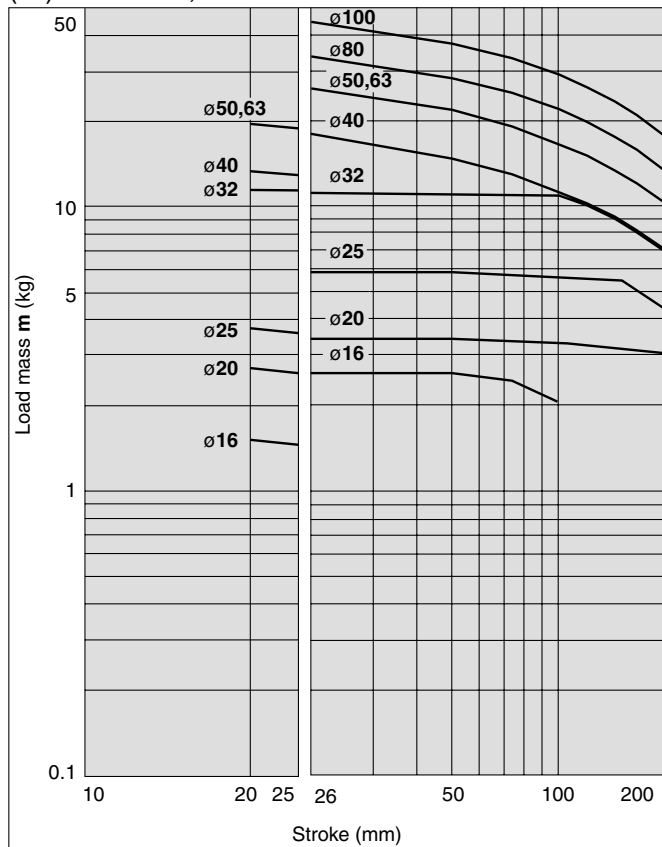

(18) $\ell = 100$ mm, $V = 400$ mm/s

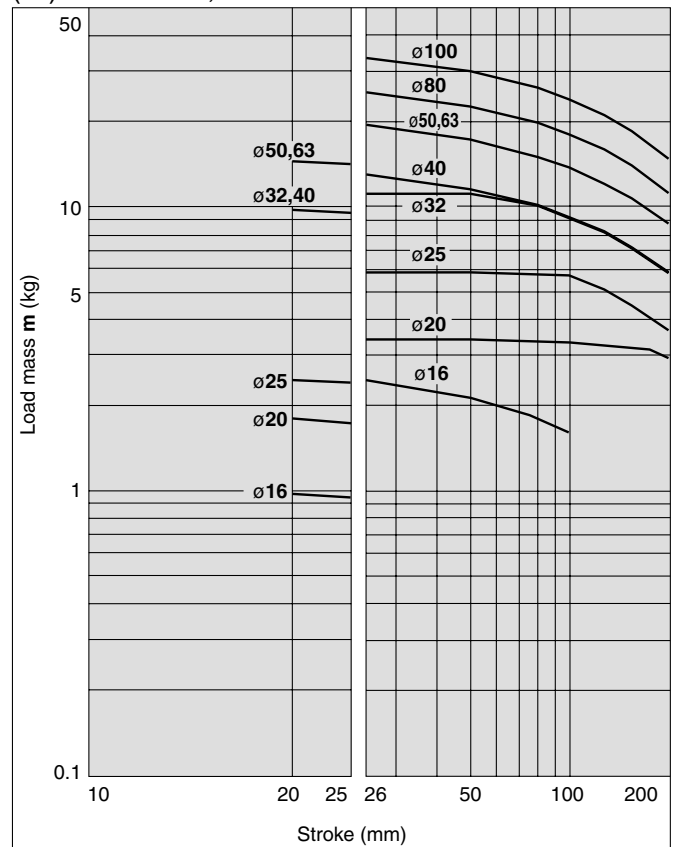

MGJ

MGP

MGQ

MGG

MGC

MGF

MGZ

MGT

D-□

-X□

Individual
-X□

Series MGP

Horizontal Mounting (Ball Bushing)

(19) $\ell = 50$ mm, $V = 200$ mm/s or less

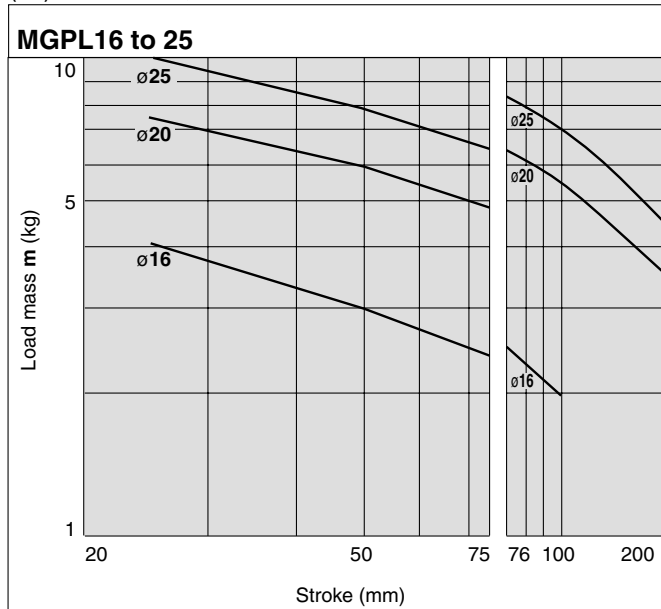

(20) $\ell = 100$ mm, $V = 200$ mm/s or less

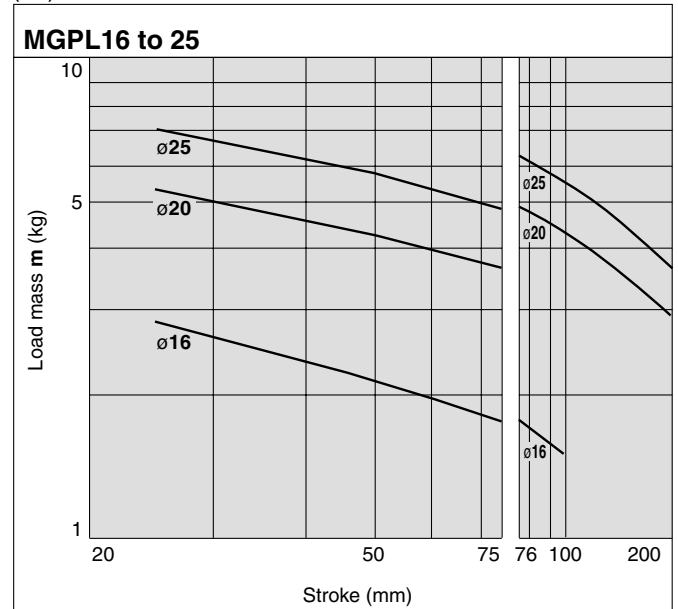

MGPL32 to 63

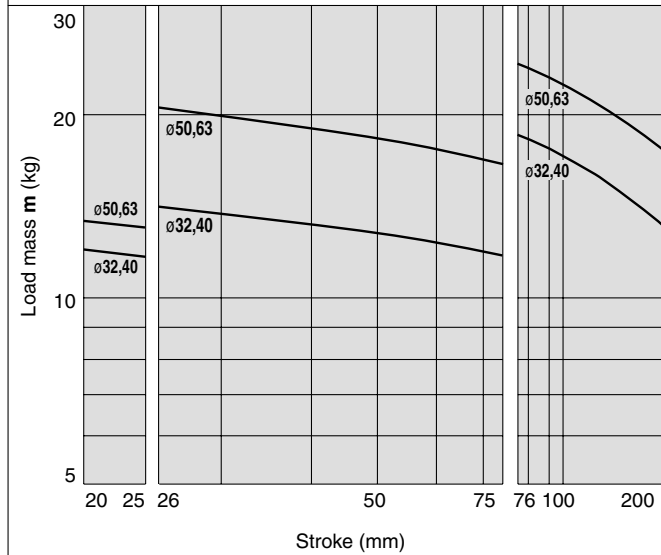

MGPL32 to 63

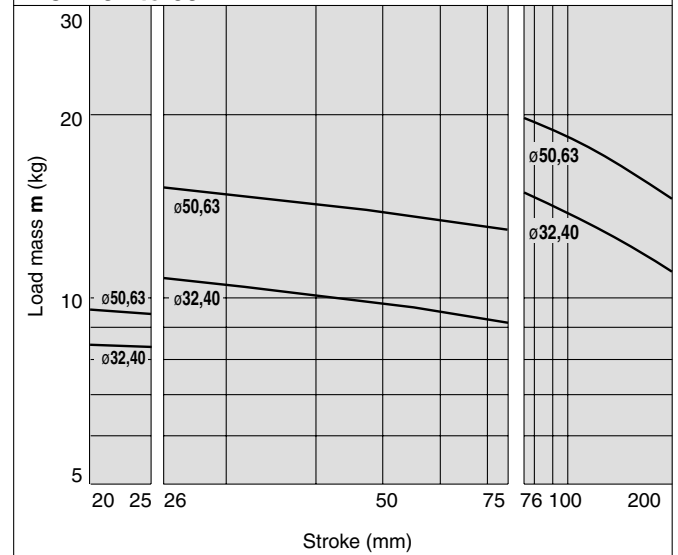

MGPL80, 100

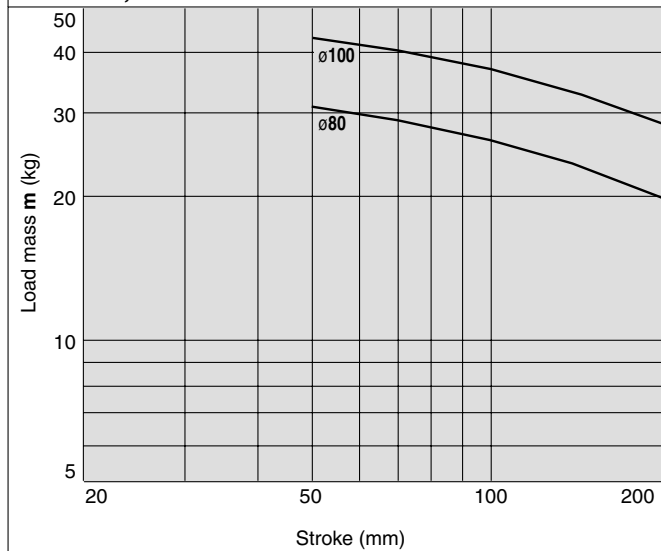

MGPL80, 100

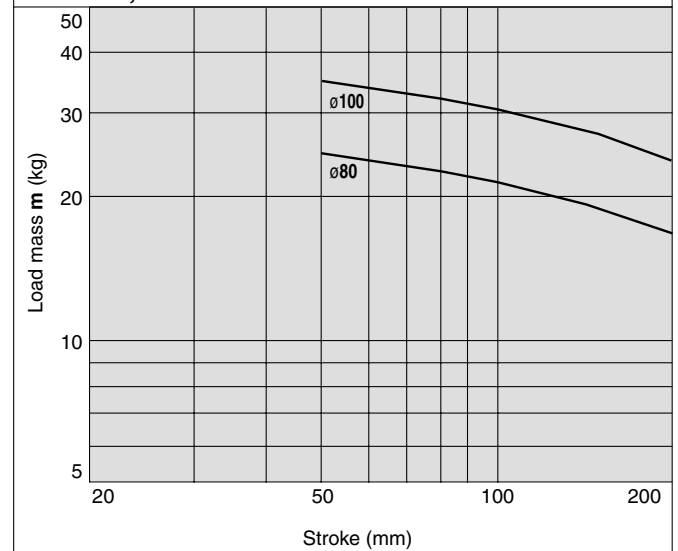

Horizontal Mounting (Ball Bushing)

(21) $\ell = 50$ mm, $V = 400$ mm/s

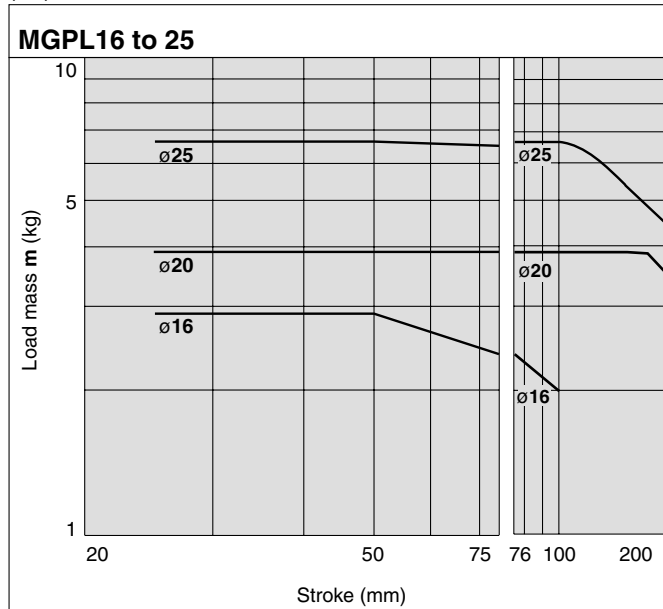

(22) $\ell = 100$ mm, $V = 400$ mm/s

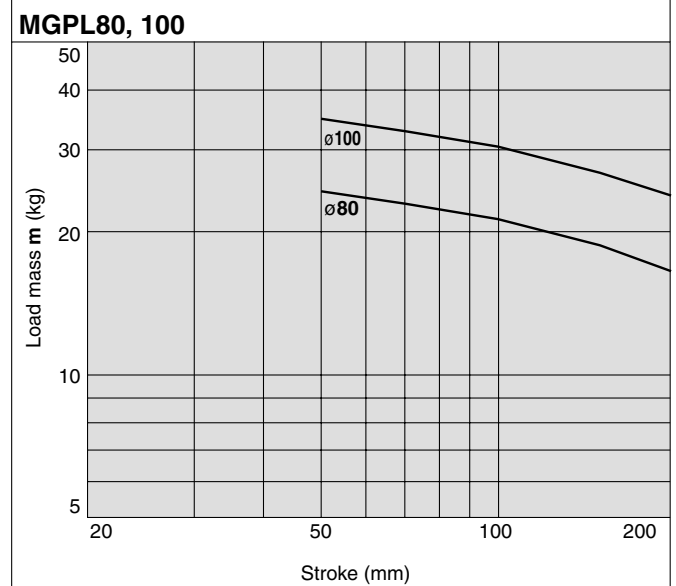
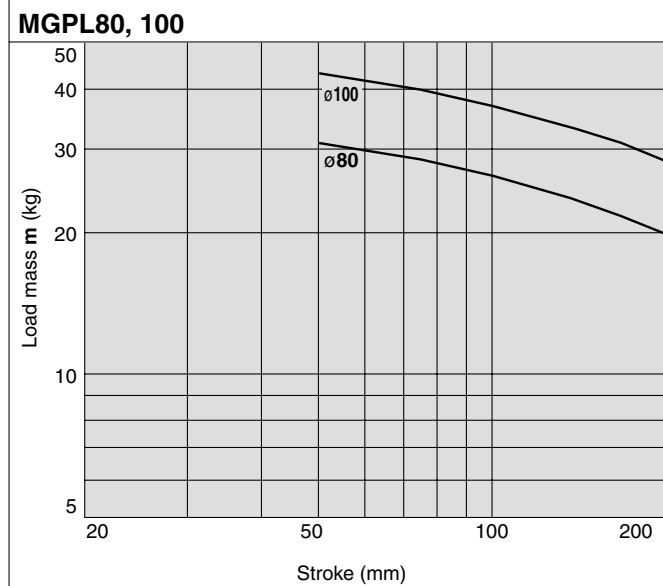
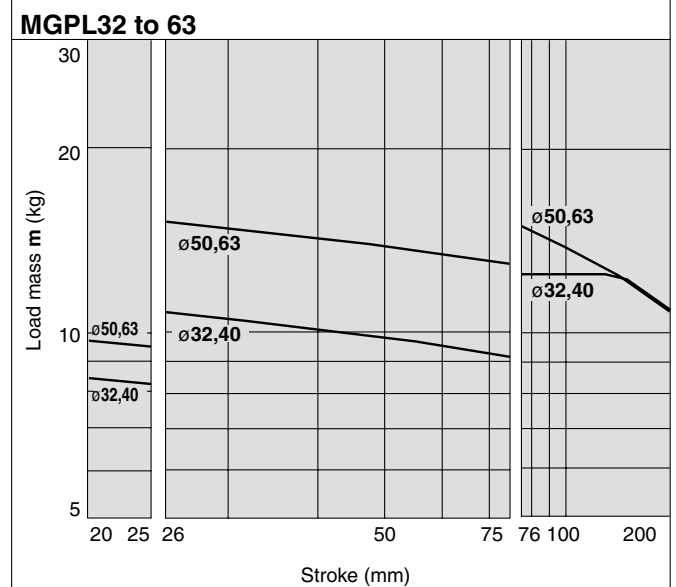
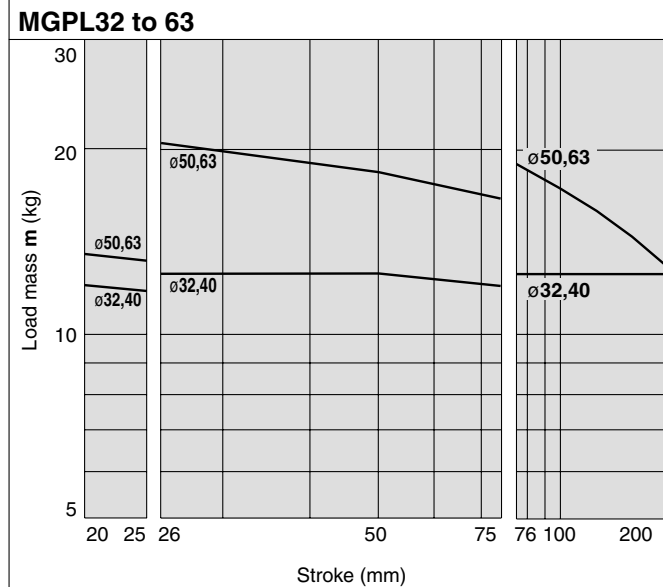
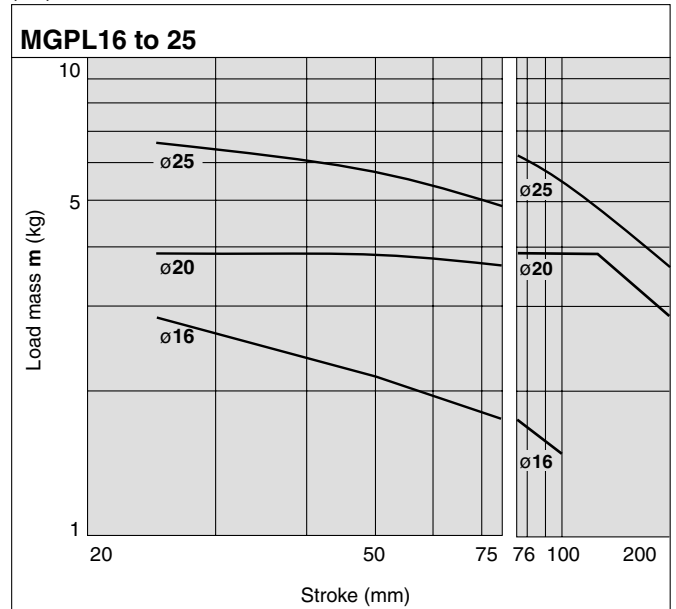

- MGJ
- MGP**
- MGQ
- MGG
- MGC
- MGF
- MGZ
- MGT

- D-
- X
- Individual
- X

Series MGP

Operating Range when Used as Stopper

Bore size $\phi 16$ to 25/MGPM16 to 25 (Slide bearing)

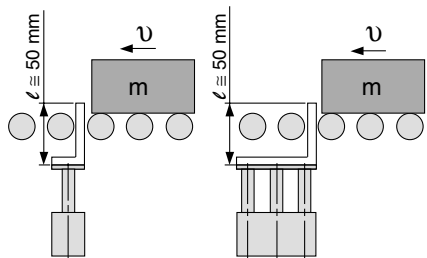

* When selecting a model with a longer l dimension, be sure to choose a bore size which is sufficiently large.

⚠ Caution

Caution on handling

Note 1) When using as a stopper, select a model with 25 stroke or less.

Note 2) Model MGPL (Ball bushing bearing) cannot be used as a stopper.

MGPM16 to 25 (Slide bearing)

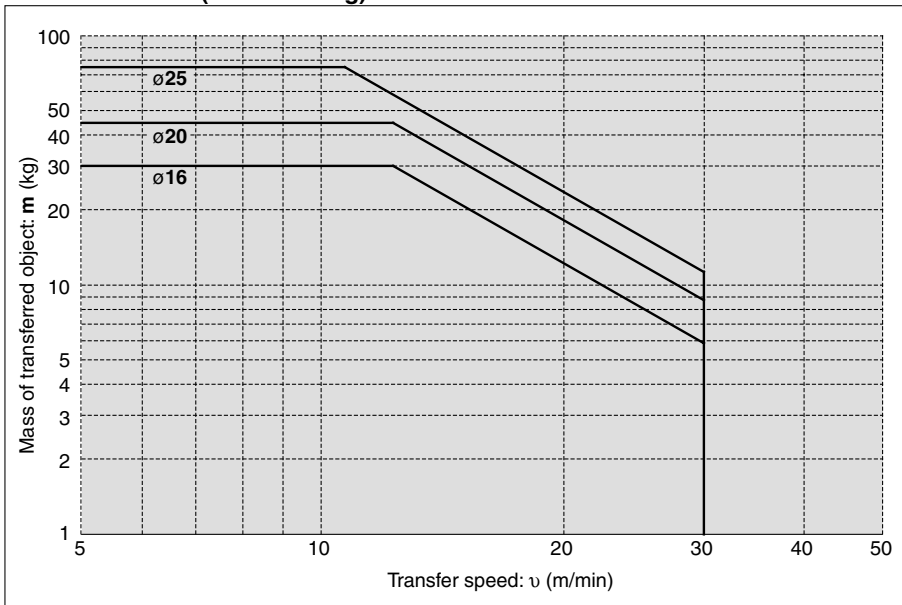

Bore Size $\phi 32$ to 100/MGPM32 to 100 (Slide bearing)

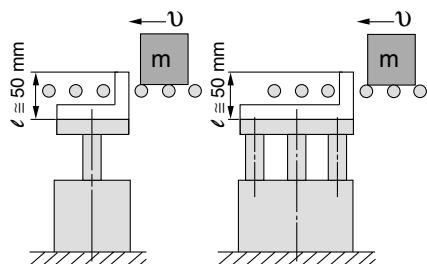

* When selecting a model with a longer l dimension, be sure to choose a bore size which is sufficiently large.

⚠ Caution

Caution on handling

Note 1) When using as a stopper, select a model with 50 stroke or less.

Note 2) Model MGPL (Ball bushing bearing) cannot be used as a stopper.

MGPM32 to 100 (Slide bearing)

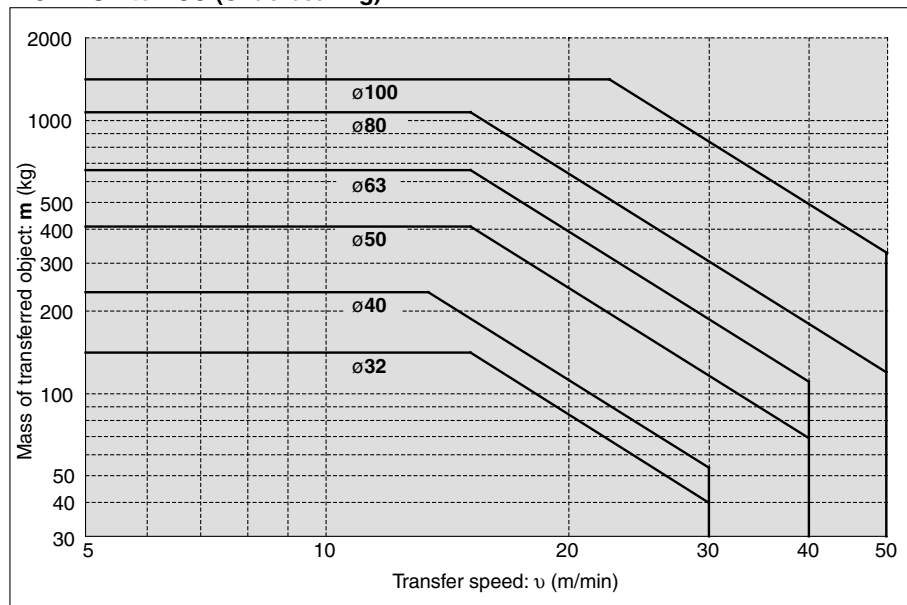

Copper and Fluorine-free Series (For CRT Manufacturing Process)

To prevent the influence of copper ions or halogen ions during CRT manufacturing processes, copper and fluorine materials are not used in the component parts.

Specifications

Applicable series	MGPM	MGPL
Bearing type	Slide bearing	Ball bushing bearing
Bore size (mm)	16, 20, 25, 32, 40, 50, 63, 80, 100	

* Specifications and dimensions other than above are the same as the standard basic style.

How to Order

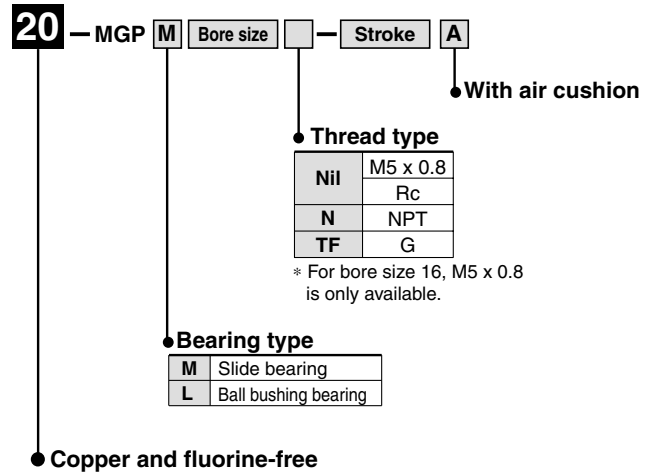

MGJ

MGP

MGQ

MGG

MGC

MGF

MGZ

MGT

D-□

-X□

Individual
-X□

Series MGP

Series MGPM/Construction (With air cushion)

MGPM16 to 25

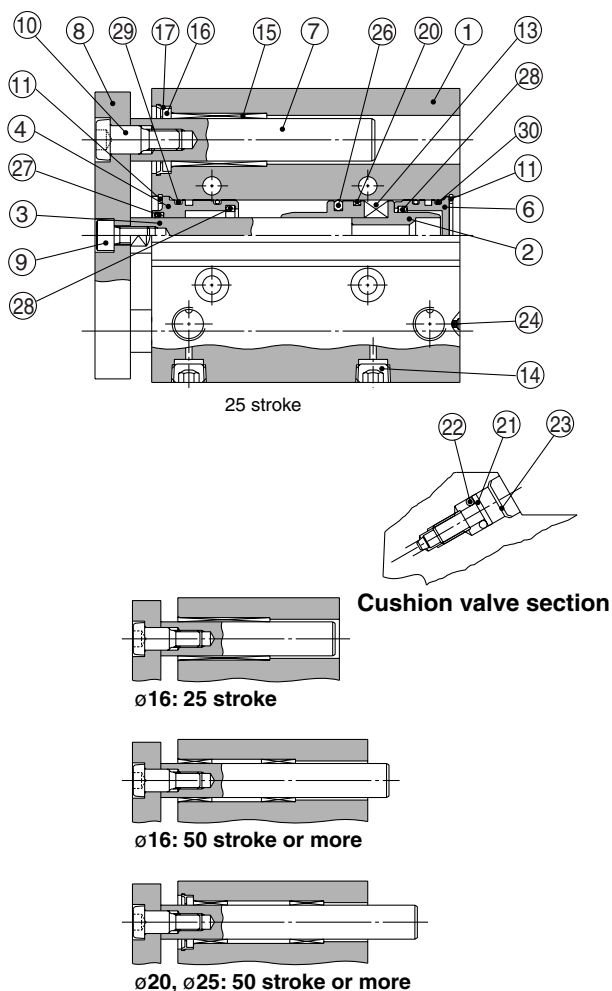

Component Parts

No.	Description	Material	Note
1	Body	Aluminum alloy	Hard anodized
2	Piston	Aluminum alloy	Chromated
3	Piston rod	Stainless steel	ø16 to ø25
		Carbon steel	ø32 to ø100 Hard chrome plated
4	Collar	Aluminum alloy	ø16 to ø63 Clear anodized ø80, ø100 Painted
5	Bushing	Babbitt	
6	Head cover	Aluminum alloy	ø16 to ø25 Clear anodized
			ø32 to ø100 Painted
7	Guide rod	Carbon steel	Hard chrome plated
8	Plate	Carbon steel	Nickel plated
9	Plate mounting bolt	Carbon steel	Nickel plated
10	Guide bolt	Carbon steel	Nickel plated
11	Retaining ring	Carbon tool steel	Phosphate coated
12	Retaining ring	Carbon tool steel	Phosphate coated
13	Magnet	—	
14	Plug Hexagon socket head cap plug	Carbon steel	ø16 Nickel plated
			ø20 to ø100
15	Slide Bearing	Babbitt	
16	Felt	Felt	
17	Holder	Resin	
18	Ball bushing		
19	Spacer	Aluminum alloy	

MGPM32 to 100

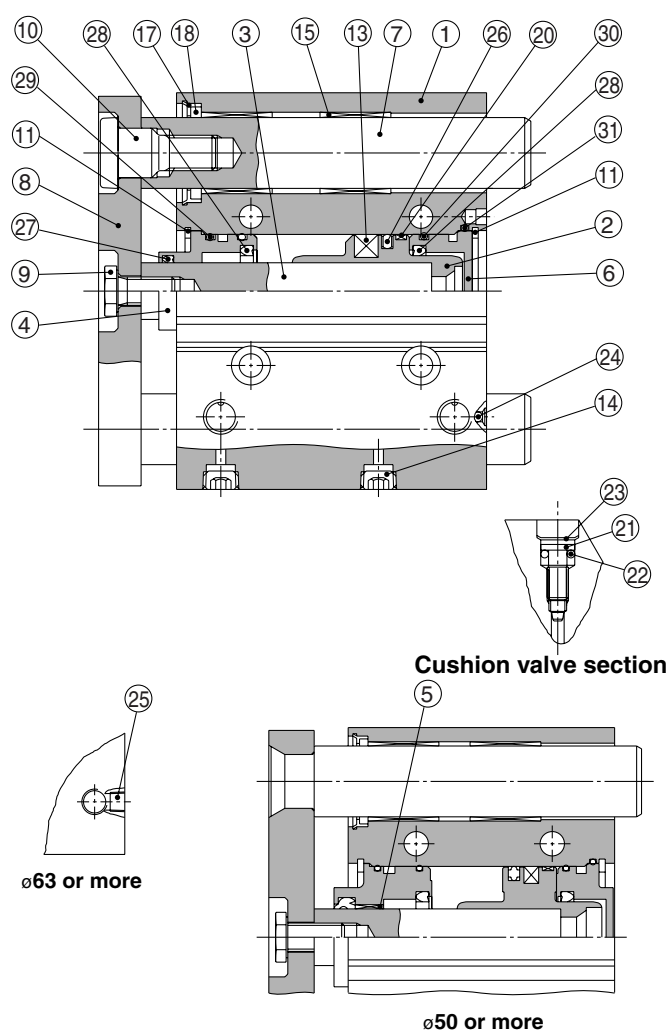

Component Parts

No.	Description	Material	Note
20	Wear ring	Resin	
21	Cushion valve	Steel	
22	Gasket	NBR	
23	Retaining ring	Carbon tool steel	Except ø16
24	Steel ball	Carbon steel	ø16 to ø50
25	Plug	Carbon steel	ø63 to ø100 Nickel plated
26*	Piston seal	NBR	
27*	Rod seal	NBR	
28*	Cushion seal	Urethane	
29*	Gasket A	NBR	
30*	Gasket B	NBR	
31*	Gasket C	NBR	

Replacement Parts: Seal Kit

Bore size (mm)	Kit no.	Contents	Bore size (mm)	Kit no.	Contents
16	MGP16-A-PS	Set of nos. above ø26, ø27, ø28, ø29, ø30, ø31	50	MGP50-A-PS	Set of nos. above ø26, ø27, ø28, ø29, ø30, ø31
20	MGP20-A-PS		63	MGP63-A-PS	
25	MGP25-A-PS		80	MGP80-A-PS	
32	MGP32-A-PS		100	MGP100-A-PS	
40	MGP40-A-PS				

* Seal kit includes ②⑥ to ③①. Order the seal kit, based on each bore size.

* Since the seal kit does not include a grease pack, order it separately.

Grease pack part no.: GR-S-010 (10 g)

Series MGPL/Construction (With Air Cushion)

MGPL16 to 25

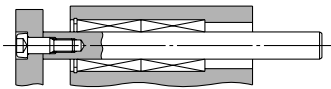
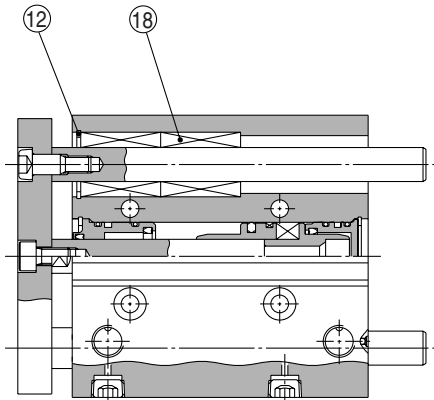

$\phi 20, \phi 25$: 75 stroke or less

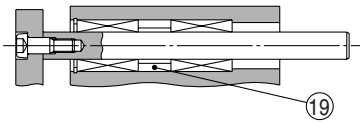

$\phi 20, \phi 25$: 100 stroke or more

MGPL32 to 100

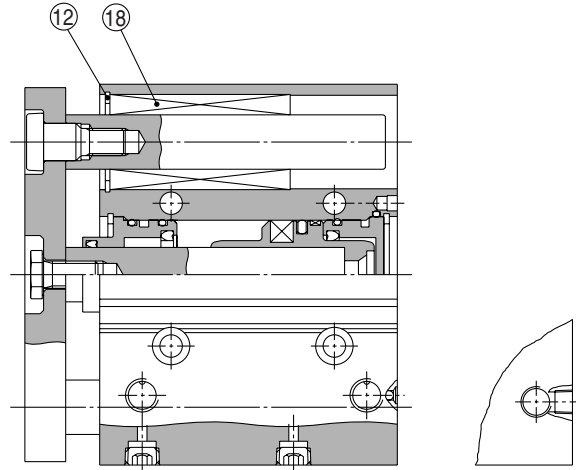

$\phi 63$ or more

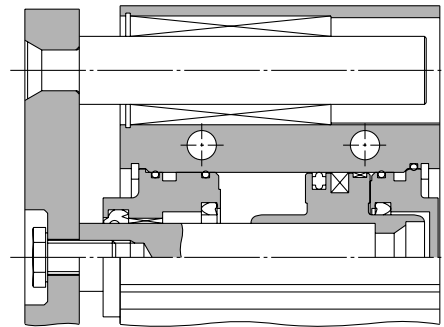

$\phi 50$ or more

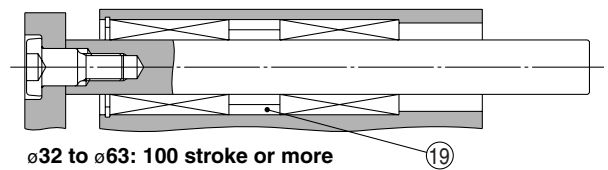

$\phi 32$ to $\phi 63$: 100 stroke or more

MGJ

MGP

MGQ

MGG

MGC

MGF

MGZ

MGT

D-□

-X□

Individual
-X□

Series MGP

MGPM, MGPL (With Air Cushion): $\phi 16$ to $\phi 25$

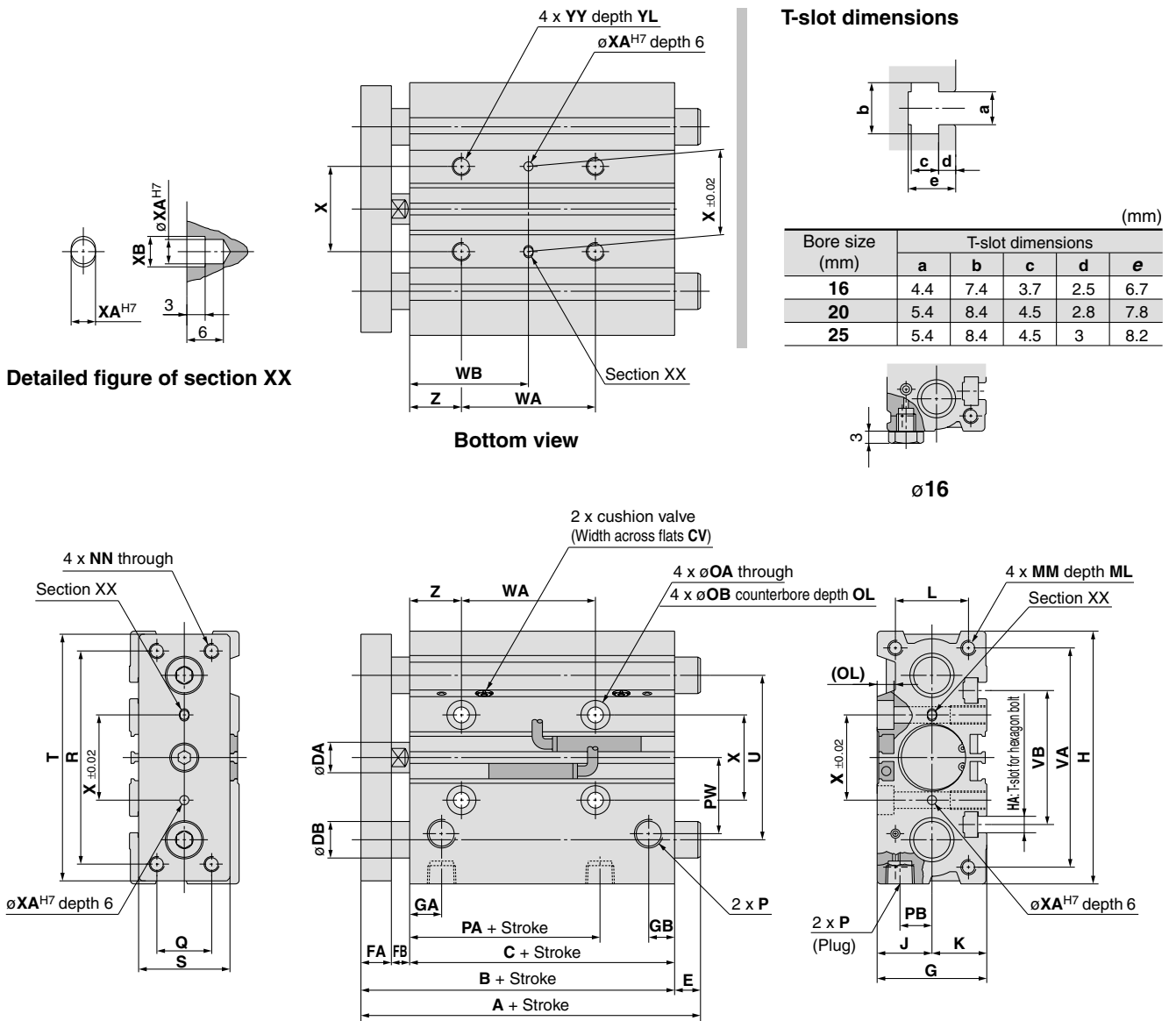

Note 1) For the intermediate strokes, refer to "Manufacture of Intermediate Stroke" on page 291.
 Note 2) When adjusting the $\phi 16$ cushion valve, use a 3 mm flat head watchmakers' screwdriver.

• For bore size with $\phi 16$, M5 x 0.8 is only available.
 • Rc, NPT, G port can be selected for bore sizes with $\phi 20$ or more. (Refer to page 290.)

MGPM, MGPL Common Dimensions

Bore size (mm)	Standard stroke (mm)	B	C	CV	DA	FA	FB	G	GA	GB	H	HA	J	K	L	MM	ML	NN	OA	OB	OL	P		
																						Nil	N	TF
16	25, 50, 75, 100, 125, 150, 175, 200, 250	71	58	—	8	8	5	30	11	8	64	M4	15	15	22	M5 x 0.8	12	M5 x 0.8	4.3	8	4.5	M5 x 0.8	—	—
20	25, 50, 75, 100, 125, 150, 175, 200, 250, 300, 350, 400	78	62	1.5	10	10	6	36	10.5	8.5	83	M5	18	18	24	M5 x 0.8	13	M5 x 0.8	5.4	9.5	5.5	Rc 1/8	NPT 1/8	G 1/8
25		78.5	62.5	1.5	12	10	6	42	11.5	9	93	M5	21	21	30	M6 x 1.0	15	M6 x 1.0	5.4	9.5	5.5	Rc 1/8	NPT 1/8	G 1/8

Bore size (mm)	PA	PB	PW	Q	R	S	T	U	VA	VB	WA				WB				X	XA	XB	YY	YL	Z
											75 st or less	100 to 175 st	200, 250 st	300 st or more	75 st or less	100 to 175 st	200, 250 st	300 st or more						
16	40	10	19	16	54	25	62	46	56	38	44	110	200	—	27	60	105	—	24	3	3.5	M5 x 0.8	10	5
20	37.5	10.5	25	18	70	30	81	54	72	44	44	120	200	300	39	77	117	167	28	3	3.5	M6 x 1.0	12	17
25	37.5	13.5	30	26	78	38	91	64	82	50	44	120	200	300	39	77	117	167	34	4	4.5	M6 x 1.0	12	17

MGPM (Slide bearing) A, DB, E Dimensions

Bore size (mm)	A					DB	E				
	25 st	50 st	75, 100 st	125 to 200 st	250 st or more		25 st	50 st	75, 100 st	125 to 200 st	250 st or more
16	71	89.5	71	95	95	10	0	18.5	0	24	24
20	78	86.5	84.5	84.5	122	12	0	8.5	6.5	6.5	44
25	78.5	87	85	85	122	16	0	8.5	6.5	6.5	43.5

MGPL (Ball bushing bearing) A, DB, E Dimensions

Bore size (mm)	A					DB	E				
	25 st	50, 75 st	100 st	125 to 200 st	250 st or more		25 st	50, 75 st	100 st	125 to 200 st	250 st or more
16	80	71	71	95	95	8	9	0	0	24	24
20	95	80	99	104	122	10	17	2	21	26	44
25	100.5	85.5	104.5	104.5	122	13	22	7	26	26	43.5

MGPM, MGPL (With Air Cushion): $\phi 32$ to $\phi 63$

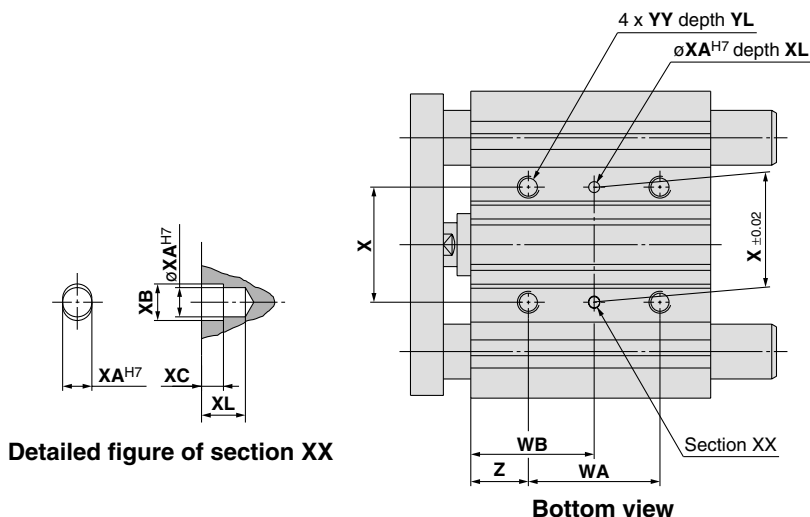

T-slot dimensions

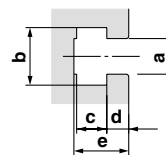

Bore size (mm)	T-slot dimensions (mm)				
	a	b	c	d	e
32	6.5	10.5	5.5	3.5	9.5
40	6.5	10.5	5.5	4	11
50	8.5	13.5	7.5	4.5	13.5
63	11	17.8	10	7	18.5

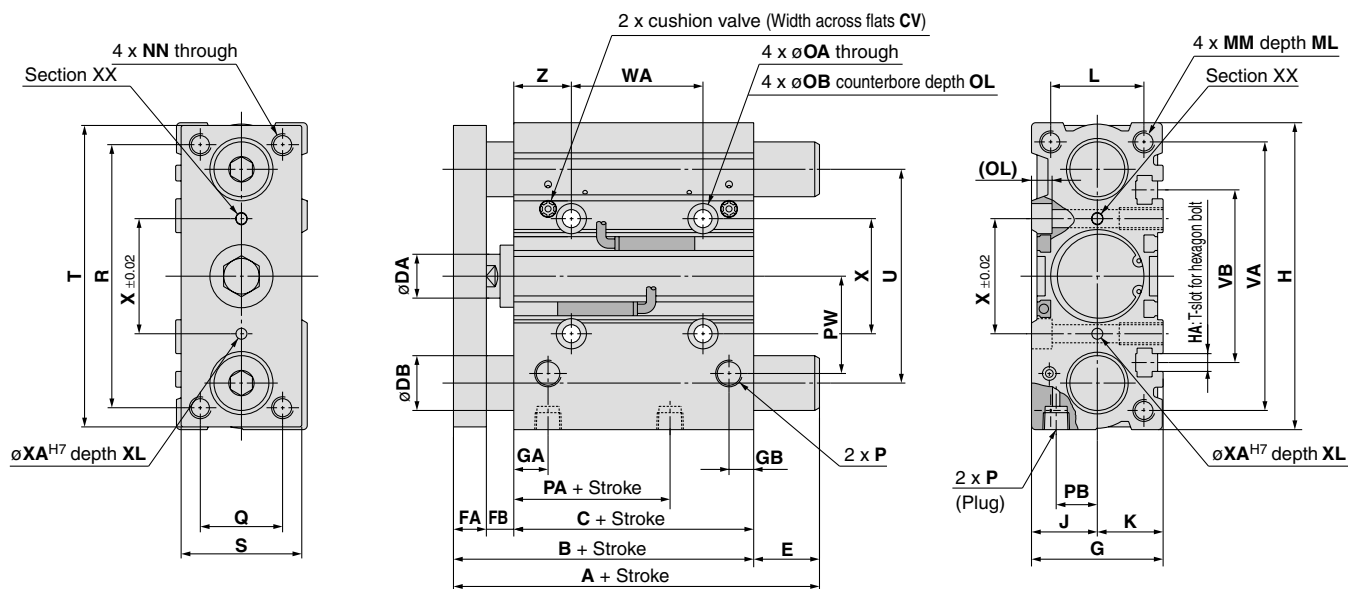

For the intermediate strokes, refer to "Manufacture of Intermediate Stroke" on page 291.

• Rc, NPT and G ports can be selected. (Refer to page 290.)

MGPM, MGPL Common Dimensions

Bore size (mm)	Standard stroke (mm)	B	C	CV	DA	FA	FB	G	GA	GB	H	HA	J	K	L	MM	ML	NN	OA	OB	OL	P		
		Nil	N	TF																				
32	25, 50, 75, 100	84.5	62.5	1.5	16	12	10	48	12.5	9	112	M6	24	24	34	M8 x 1.25	20	M8 x 1.25	6.6	11	7.5	Rc 1/8	NPT 1/8	G 1/8
40	125, 150, 175	91	69	1.5	16	12	10	54	14	10	120	M6	27	27	40	M8 x 1.25	20	M8 x 1.25	6.6	11	7.5	Rc 1/8	NPT 1/8	G 1/8
50	200, 250, 300	97	69	2.5	20	16	12	64	14	11	148	M8	32	32	46	M10 x 1.5	22	M10 x 1.5	8.6	14	9	Rc 1/4	NPT 1/4	G 1/4
63	350, 400	102	74	2.5	20	16	12	78	16.5	13.5	162	M10	39	39	58	M10 x 1.5	22	M10 x 1.5	8.6	14	9	Rc 1/4	NPT 1/4	G 1/4

Bore size (mm)	PA	PB	PW	Q	R	S	T	U	VA	VB	WA				WB				X	XA	XB	XC	XL	YY	YL	Z	
	75 st or less	100 to 175 st	200, 250 st	300 st or more	75 st or less	100 to 175 st	200, 250 st	300 st or more	X	XA	XB	XC	XL	YY	YL	Z											
32	32	15	35.5	30	96	44	110	78	98	63	48	124	200	300	300	45	83	121	171	42	4	4.5	3	6	M8 x 1.25	16	21
40	38	18	39.5	30	104	44	118	86	106	72	48	124	200	300	46	84	122	172	50	4	4.5	3	6	M8 x 1.25	16	22	
50	34	21.5	47	40	130	60	146	110	130	92	48	124	200	300	48	86	124	174	66	5	6	4	8	M10 x 1.5	20	24	
63	39	28	58	50	130	70	158	124	142	110	52	128	200	300	50	88	124	174	80	5	6	4	8	M10 x 1.5	20	24	

MGPM (Slide bearing) A, DB, E Dimensions (mm)

Bore size (mm)	A				DB	E			
	25st	50st	75 to 200 st	250 st or more		25st	50st	75 to 200 st	250 st or more
32	97	127	102	140	20	12.5	42.5	17.5	55.5
40	97	127	102	140	20	6	36	11	49
50	106.5	131.5	118	161	25	9.5	34.5	21	64
63	106.5	131.5	118	161	25	4.5	29.5	16	59

MGPL (Ball bushing bearing) A, DB, E Dimensions (mm)

Bore size (mm)	A					DB	E						
	25st	50st	75st	100st	125 to 200 st		250 st or more	25st	50st	75st	100st	125 to 200 st	250 st or more
32	84.5	123	98	115.5	118	140	16	0	38.5	13.5	31	33.5	55.5
40	91	123	98	115.5	118	140	16	0	32	7	24.5	27	49
50	97	127.5	114	159	134	161	20	0	30.5	17	62	37	64
63	102	127.5	114	159	134	161	20	0	25.5	12	57	32	59

- MGJ
- MGP
- MGQ
- MGG
- MGC
- MGF
- MGZ
- MGT

- D-□
- X□
- Individual -X□

Series MGP

MGPM, MGPL (With Air Cushion): $\phi 80, \phi 100$

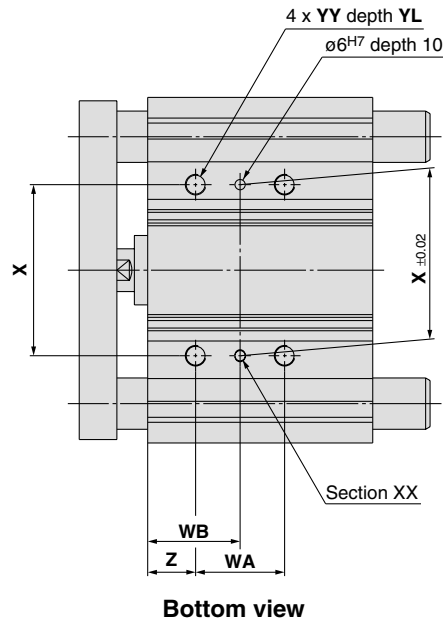

T-slot dimensions

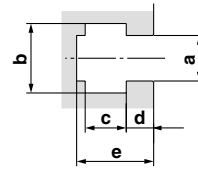

Bore size (mm)	T-slot dimensions (mm)				
	a	b	c	d	e
80	13.3	20.3	12	8	22.5
100	15.3	23.3	13.5	10	30

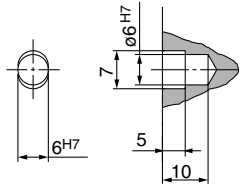

Detailed figure of section XX

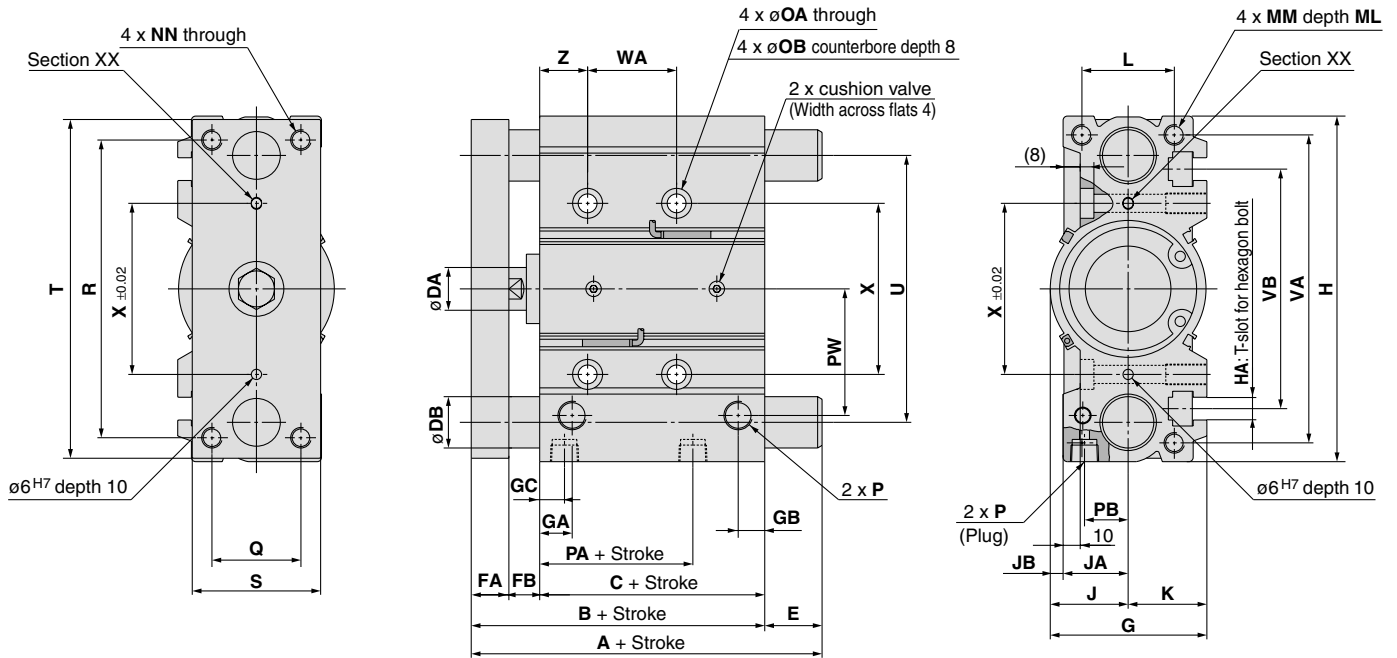

For the intermediate strokes, refer to "Manufacture of Intermediate Stroke" on page 291.

Rc, NPT and G ports can be selected. (Refer to page 290.)

MGPM, MGPL Common Dimensions

Bore size (mm)	Standard stroke (mm)	B	C	DA	FA	FB	G	GA	GB	GC	H	HA	J	JA	JB	K	L	MM	ML	NN	OA	OB	P		
																							Nil	N	TF
80	50,75,100,125 150,175,200,250 300,350,400	121.5	81.5	25	22	18	91.5	19	15.5	14.5	202	M12	45.5	38	7.5	46	54	M12 x 1.75	25	M12 x 1.75	10.6	17.5	Rc 3/8	NPT 3/8	G 3/8
100		141	91	30	25	25	111.5	23	19	18	240	M14	55.5	45	10.5	56	62	M14 x 2.0	31	M14 x 2.0	12.5	20	Rc 3/8	NPT 3/8	G 3/8
Bore size (mm)	PA	PB	PW	Q	R	S	T	U	VA	VB	WA				WB				X	YY	YL	Z			
											50, 75 st	100 to 175 st	200, 250 st	300 st or more	50, 75 st	100 to 175 st	200, 250 st	300 st or more							
80	39.5	25.5	74	52	174	75	198	156	180	140	52	128	200	300	54	92	128	178	100	M12 x 1.75	24	28			
100	42.5	32.5	89	64	210	90	236	188	210	166	72	148	220	320	47	85	121	171	124	M14 x 2.0	28	11			

MGPM (Slide bearing) A, DB, E Dimensions

Bore size (mm)	A			DB	E		
	50 st	75 to 200 st	250 st or more		50 st	75 to 200 st	250 st or more
80	167	142	193	30	45.5	20.5	71.5
100	187	162	203	36	46	21	62

MGPL (Ball bushing bearing) A, DB, E Dimensions

Bore size (mm)	A			DB	E		
	50 st	75 to 200 st	250 st or more		50 st	75 to 200 st	250 st or more
80	168.5	160	193	25	47	38.5	71.5
100	178.5	180	203	30	37.5	39	62

Compact Guide Cylinder/With End Lock

Series *MGP*

∅20, ∅25, ∅32, ∅40, ∅50, ∅63, ∅80, ∅100

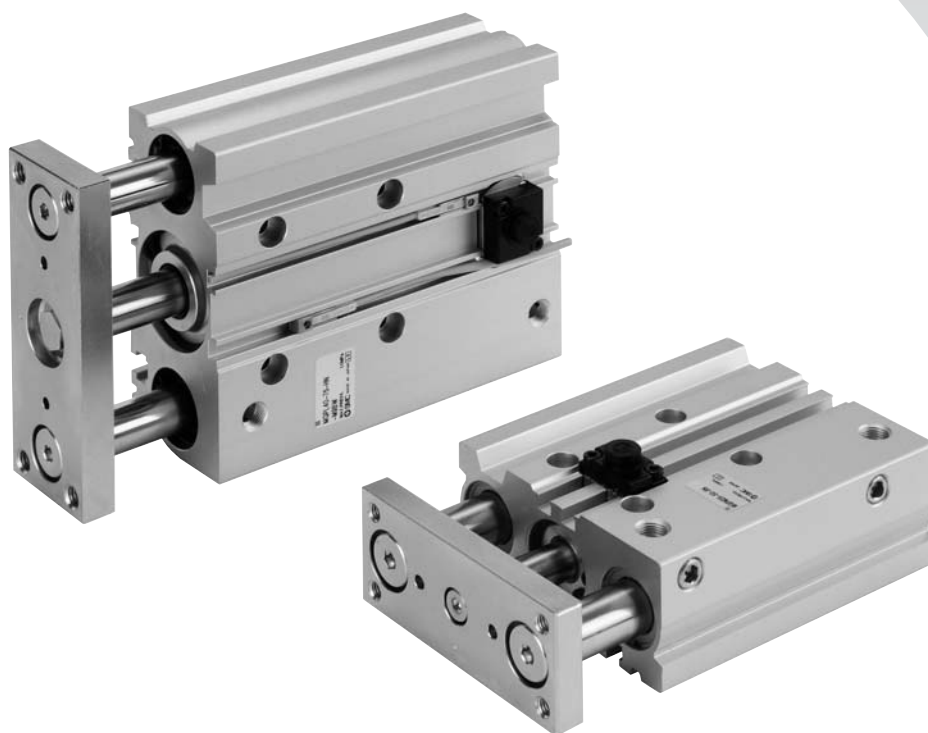

MGJ

MGP

MGQ

MGG

MGK

MGF

MGZ

MGY

Stroke Variations

Bearing type	Bore size (mm)	Stroke (mm)													Intermediate stroke	Locking direction	Manual release	
		25	50	75	100	125	150	175	200	250	300	350	400					
MGPM Slide bearing	20	●	●	●	●	●	●	●	●	●	●	●	●	●	●	Spacer installation type Available by the 5 mm interval.	Rod end lock	Non-lock type
	25	●	●	●	●	●	●	●	●	●	●	●	●	●				
	32	●	●	●	●	●	●	●	●	●	●	●	●	●				
	40	●	●	●	●	●	●	●	●	●	●	●	●	●				
MGPL Ball bushing bearing	50	●	●	●	●	●	●	●	●	●	●	●	●	●	Head end lock	Lock type		
	63	●	●	●	●	●	●	●	●	●	●	●	●	●				
	80	●	●	●	●	●	●	●	●	●	●	●	●	●				
	100	●	●	●	●	●	●	●	●	●	●	●	●	●				

D-□

-X□

Individual
-X□

Compact Guide Cylinder/With End Lock

Series MGP

ø20, ø25, ø32, ø40, ø50, ø63, ø80, ø100

How to Order

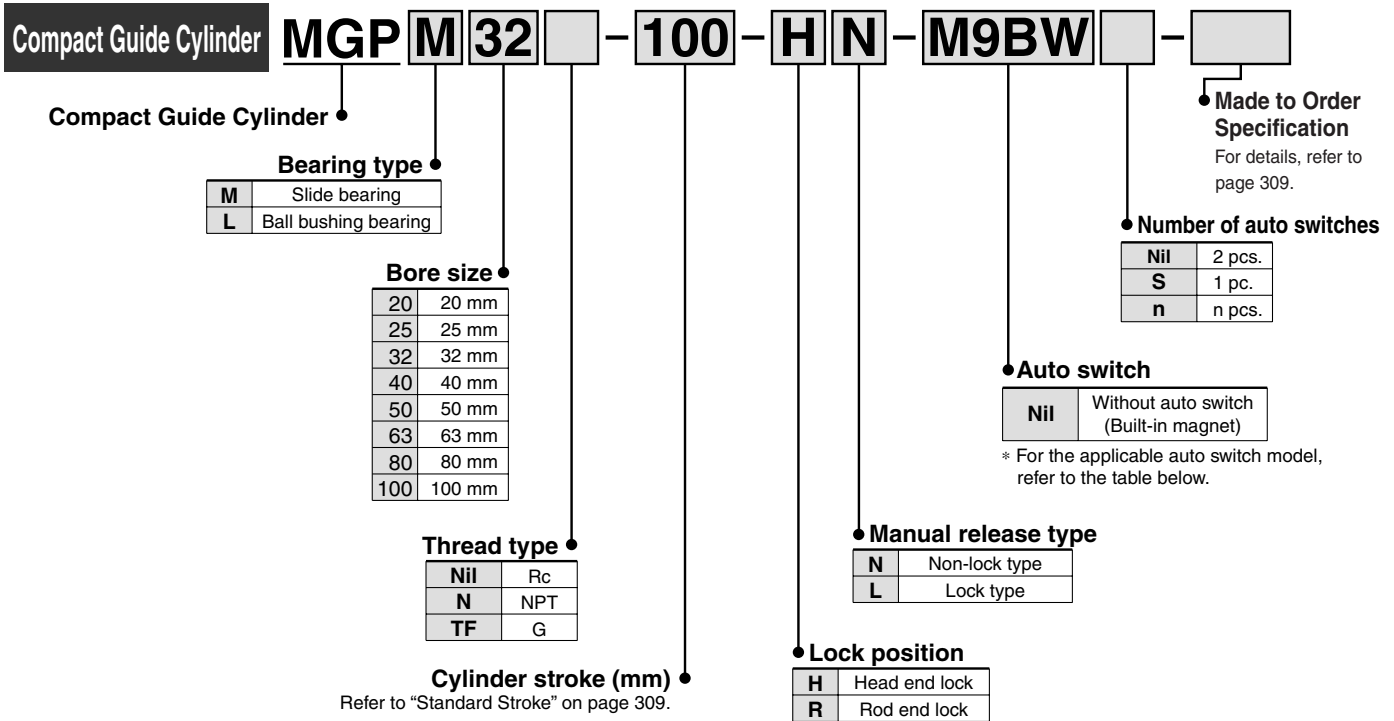

Applicable Auto Switch/Refer to pages 1719 to 1827 for further information on auto switches.

Type	Special function	Electrical entry	Indicator light	Wiring (Output)	Load voltage		Auto switch model		Lead wire length (m)				Pre-wired connector	Applicable load				
					DC	AC	Perpendicular	In-line	0.5 (Nil)	1 (M)	3 (L)	5 (Z)		IC circuit	Relay, PLC			
Solid state switch	—	Grommet	Yes	3-wire (NPN)	24V	5V, 12V	—	M9NV	M9N	●	●	●	○	○	IC circuit	Relay, PLC		
				3-wire (PNP)				M9PV	M9P	●	●	●	○	○				
				2-wire				M9BV	M9B	●	●	●	○	○				
				3-wire (NPN)				M9NWV	M9NW	●	●	●	○	○				
	Diagnostic indication (2-color indication)			3-wire (PNP)	5V, 12V	—	M9PWV	M9PW	●	●	●	○	○	○	○	IC circuit	Relay, PLC	
				2-wire	12V	—	M9BWV	M9BW	●	●	●	○	○	○	○	—		
	Water resistant (2-color indication)			3-wire (NPN)	5V, 12V	—	M9NAV	M9NA	○	○	●	○	○	○	○	IC circuit	Relay, PLC	
				3-wire (PNP)			M9PAV	M9PA	○	○	●	○	○	○	○	IC circuit		
2-wire		M9BAV	M9BA	○			○	●	○	○	○	○	—					
2-wire (Non-polar)		—	P4DW	—			—	●	●	○	○	○	—					
Reed switch	—	Grommet	No	3-wire (NPN equivalent)	24V	5V	—	A96V	A96	●	—	●	—	—	IC circuit	—		
				2-wire				100V	A93V	A93	●	—	●	—	—	—	—	Relay, PLC
								100V or less	A90V	A90	●	—	●	—	—	—	—	

* Lead wire length symbols: 0.5 m..... Nil (Example) M9NW
 1 m..... M (Example) M9NWM
 3 m..... L (Example) M9NWL
 5 m..... Z (Example) M9NWZ

* Solid state auto switches marked with "○" are produced upon receipt of order.
 * D-P4DW type can be mounted on bore sizes 32 to 100.

* Since there are other applicable auto switches than listed, refer to page 336 for details.
 * For details about auto switches with pre-wired connector, refer to pages 1784 and 1785.
 * Auto switches are shipped together (not assembled).

Specifications

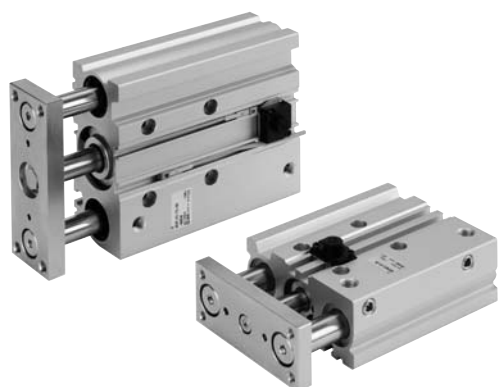

Bore size	ø20	ø25	ø32	ø40	ø50	ø63	ø80	ø100
Action	Double acting							
Fluid	Air							
Proof pressure	1.5 MPa							
Maximum operating pressure	1.0 MPa							
Minimum operating pressure	0.15 MPa *							
Ambient and fluid temperature	-10 to 60°C (No freezing)							
Piston speed	50 to 500 mm/s						50 to 400 mm/s	
Cushion	Rubber bumper on both ends							
Lubrication	Not required (Non-lube)							
Stroke length tolerance	$^{+1.5}_0$ mm							

* 0.1 MPa except the lock unit.

Lock Specifications

Lock position	Head end, Rod end							
Holding force (Max.) N	ø20	ø25	ø32	ø40	ø50	ø63	ø80	ø100
	215	330	550	860	1340	2140	3450	5390
Backlash	2 mm or less							
Manual release	Non-lock type, Lock type							

Adjust switch positions for operation at both the stroke end and backlash (2 mm) movement positions.



Made to Order Specifications

(For details, refer to pages 1847 and 1995.)

Symbol	Specifications
—XC79	Machining tapped hole, drilled hole and pin hole additionally.
—X867	Lateral piping type (Change of plug position)

Refer to pages 334 to 336 for cylinders with auto switches.

- Minimum auto switch mounting stroke
- Proper auto switch mounting position (detection at stroke end) and mounting height
- Operating range
- Switch mounting bracket: Part no.

Standard Stroke

Bore size (mm)	Standard stroke (mm)
20, 25, 32, 40, 50, 63, 80, 100	25, 50, 75, 100, 125, 150, 175, 200, 250, 300, 350, 400

Manufacture of Intermediate Stroke

Description	Spacer installation type. Dealing with the stroke by the 5 mm interval is available by installing spacer with standard stroke cylinder. When a spacer is mounted on the cylinder with an end lock on the rod side, use a special piston rod.
Part no.	Refer to "How to Order" for the standard model numbers on page 308.
Applicable stroke (mm)	5 to 395
Example	Part no.: MGPM50-35-HN A spacer 15 mm in width is installed in a MGPM50-50-HN. C dimension is 119 mm.

Note 1) The minimum stroke for mounting auto switches is 10 stroke or more for two switches, and 5 stroke or more for one switch.
Note 2) Intermediate stroke (by the 1 mm interval) based on an exclusive body will be available upon request for special.

Theoretical Output

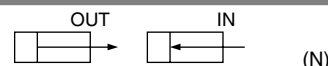

Bore size (mm)	Rod size (mm)	Operating direction	Piston area (mm ²)	Operating pressure (MPa)									
				0.2	0.3	0.4	0.5	0.6	0.7	0.8	0.9	1.0	
20	10	OUT	314	63	94	126	157	188	220	251	283	314	
		IN	236	47	71	94	118	142	165	189	212	236	
25	12	OUT	491	98	147	196	246	295	344	393	442	491	
		IN	378	76	113	151	189	227	265	302	340	378	
32	16	OUT	804	161	241	322	402	482	563	643	724	804	
		IN	603	121	181	241	302	362	422	482	543	603	
40	16	OUT	1257	251	377	503	629	754	880	1006	1131	1257	
		IN	1056	211	317	422	528	634	739	845	950	1056	
50	20	OUT	1963	393	589	785	982	1178	1374	1570	1767	1963	
		IN	1649	330	495	660	825	990	1154	1319	1484	1649	
63	20	OUT	3117	623	935	1247	1559	1870	2182	2494	2805	3117	
		IN	2803	561	841	1121	1402	1682	1962	2242	2523	2803	
80	25	OUT	5027	1005	1508	2011	2514	3016	3519	4022	4524	5027	
		IN	4536	907	1361	1814	2268	2722	3175	3629	4082	4536	
100	30	OUT	7854	1571	2356	3142	3927	4712	5498	6283	7069	7854	
		IN	7147	1429	2144	2859	3574	4288	5003	5718	6432	7147	

Note) Theoretical output (N) = Pressure (MPa) x Piston area (mm²)

MGJ
MGP
MGQ
MGG
MGC
MGF
MGZ
MGT

D-□
-X□
Individual
-X□

Series MGP

Mass

Slide Bearing: MGPM20 to 100 (Basic mass)

(kg)

Bore size (mm)	Model	Standard stroke (mm)											
		25	50	75	100	125	150	175	200	250	300	350	400
20	MGPM20	0.86	1.12	1.32	1.52	1.71	1.91	2.11	2.31	2.78	3.18	3.57	3.97
25	MGPM25	1.18	1.56	1.83	2.10	2.38	2.65	2.92	3.19	3.85	4.39	4.94	5.48
32	MGPM32	1.92	2.32	2.70	3.09	3.47	3.85	4.23	4.61	5.56	6.32	7.09	7.85
40	MGPM40	2.20	2.66	3.08	3.51	3.93	4.36	4.78	5.20	6.24	7.10	7.95	8.80
50	MGPM50	3.73	4.46	5.10	5.74	6.38	7.02	7.66	8.30	9.91	11.2	12.5	13.8
63	MGPM63	4.61	5.45	6.21	6.96	7.72	8.47	9.23	9.99	11.8	13.3	14.8	16.3
80	MGPM80	7.88	8.70	9.49	10.3	11.2	12.0	12.8	13.9	15.5	17.2	18.8	20.5
100	MGPM100	12.1	13.2	14.4	15.6	16.8	18.0	19.1	20.6	22.9	25.3	27.6	30.0

Ball Bushing Bearing: MGPL20 to 100 (Basic mass)

(kg)

Bore size (mm)	Model	Standard stroke (mm)											
		25	50	75	100	125	150	175	200	250	300	350	400
20	MGPL20	0.93	1.10	1.27	1.48	1.65	1.83	2.00	2.17	2.55	2.90	3.25	3.60
25	MGPL25	1.27	1.50	1.74	2.01	2.24	2.47	2.70	2.94	3.44	3.91	4.37	4.83
32	MGPL32	1.74	2.19	2.51	2.88	3.20	3.51	3.83	4.15	4.84	5.47	6.10	6.73
40	MGPL40	2.02	2.51	2.87	3.29	3.65	4.01	4.37	4.73	5.51	6.23	6.95	7.67
50	MGPL50	3.46	4.21	4.76	5.40	5.95	6.50	7.05	7.60	8.83	9.92	11.1	12.2
63	MGPL63	4.33	5.20	5.86	6.62	7.28	7.95	8.61	9.27	10.7	12.1	13.4	14.7
80	MGPL80	8.05	8.87	9.66	10.5	11.4	12.2	13.0	14.1	15.7	17.4	19.0	20.7
100	MGPL100	12.4	13.5	14.7	15.9	17.1	18.3	19.4	20.9	23.2	25.6	27.9	30.3

Lock Unit Additional Mass

(kg)

Bore size (mm)	Head end lock		Rod end lock	
	HN	HL	RN	RL
20	0.05	0.07	0.05	0.06
25	0.06	0.07	0.05	0.07
32	0.09	0.10	0.09	0.10
40	0.15	0.18	0.14	0.18
50	0.24	0.27	0.23	0.27

Bore size (mm)	Head end lock		Rod end lock	
	HN	HL	RN	RL
63	0.36	0.40	0.35	0.39
80	0.90	0.97	1.03	1.10
100	1.52	1.60	1.60	1.68

Calculation: (Example) **MGPM50-100-HN**
 • Basic Mass + Lock unit additional mass
 • 5.74 + 0.24 = 5.98 kg

Allowable Rotational Torque of Plate

Non-rotating Accuracy of Plate

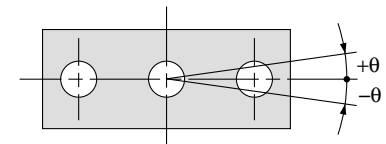
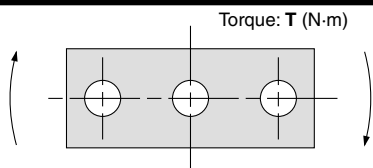

Bore size (mm)	Bearing type	Stroke (mm)											
		25	50	75	100	125	150	175	200	250	300	350	400
20	MGPM	0.99	0.75	1.88	1.63	1.44	1.28	1.16	1.06	0.90	0.78	0.69	0.62
	MGPL	2.66	1.94	1.52	1.25	1.34	1.17	1.03	0.93	0.76	0.65	0.56	0.49
25	MGPM	1.64	1.25	2.96	2.57	2.26	2.02	1.83	1.67	1.42	1.24	1.09	0.98
	MGPL	4.08	3.02	2.38	1.97	2.05	1.78	1.58	1.41	1.16	0.98	0.85	0.74
32	MGPM	6.35	5.13	5.69	4.97	4.42	3.98	3.61	3.31	2.84	2.48	2.20	1.98
	MGPL	5.95	4.89	5.11	4.51	6.34	5.79	5.33	4.93	4.29	3.78	3.38	3.04
40	MGPM	7.00	5.66	6.27	5.48	4.87	4.38	5.98	3.65	3.13	2.74	2.43	2.19
	MGPL	6.55	5.39	5.62	4.96	6.98	6.38	5.87	5.43	4.72	4.16	3.71	3.35
50	MGPM	13.0	10.8	12.0	10.6	9.50	8.60	7.86	7.24	6.24	5.49	4.90	4.43
	MGPL	9.17	7.62	9.83	8.74	11.6	10.7	9.83	9.12	7.95	7.02	6.26	5.63
63	MGPM	14.7	12.1	13.5	11.9	10.7	9.69	8.86	8.16	7.04	6.19	5.52	4.99
	MGPL	10.2	8.48	11.0	9.74	13.0	11.9	11.0	10.2	8.84	7.80	6.94	6.24
80	MGPM	21.9	18.6	22.9	20.5	18.6	17.0	15.6	14.5	12.6	11.2	10.0	9.11
	MGPL	15.1	23.3	22.7	20.6	18.9	17.3	16.0	14.8	12.9	11.3	10.0	8.94
100	MGPM	38.8	33.5	37.5	33.8	30.9	28.4	26.2	24.4	21.4	19.1	17.2	15.7
	MGPL	27.1	30.6	37.9	34.6	31.8	29.3	27.2	25.3	22.1	19.5	17.3	15.5

For non-rotating accuracy θ without load, use a value no more than the values in the table as a guide.

Bore size (mm)	Non-rotating accuracy θ	
	MGPM	MGPL
20	$\pm 0.07^\circ$	$\pm 0.09^\circ$
25	$\pm 0.07^\circ$	$\pm 0.09^\circ$
32	$\pm 0.06^\circ$	$\pm 0.08^\circ$
40	$\pm 0.06^\circ$	$\pm 0.08^\circ$
50	$\pm 0.05^\circ$	$\pm 0.06^\circ$
63	$\pm 0.05^\circ$	$\pm 0.06^\circ$
80	$\pm 0.04^\circ$	$\pm 0.05^\circ$
100	$\pm 0.04^\circ$	$\pm 0.05^\circ$

Model selection is the same as MGP/standard type.
 Refer to pages 275 to 281.

Series MGP

Construction/Series MGPM

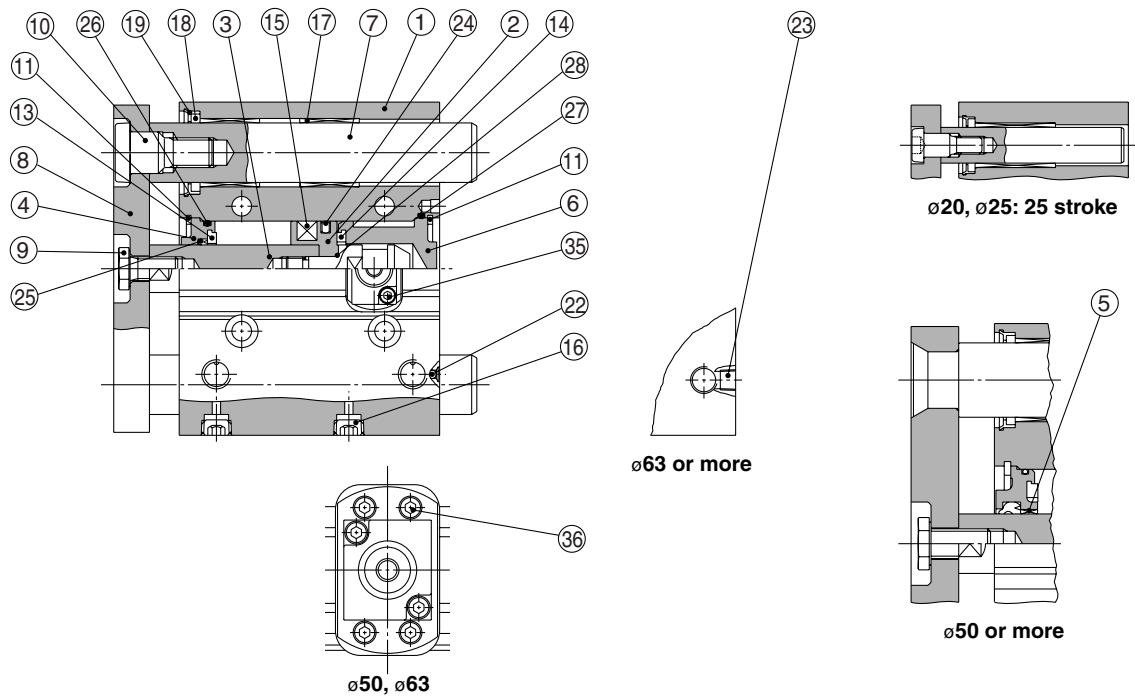

Non-locking type (Head end lock)

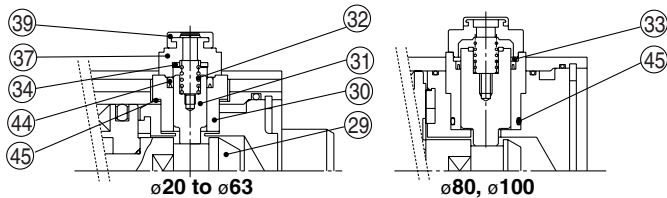

(Rod end lock)

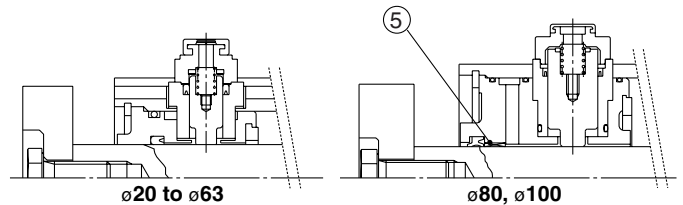

Component Parts

No.	Description	Material	Note
1	Body	Aluminum alloy	Hard anodized
2	Piston	Aluminum alloy	Chromated
3	Piston rod	Stainless steel ø20, ø25 Carbon steel ø32 to ø100	Hard chrome plated with rod end lock only Hard chrome plated
4	Collar	Aluminum alloy	Chromated
5	Bushing	Babbitt	
6	Head cover	Aluminum alloy	Chromated
7	Guide rod	Carbon steel	Hard chrome plated
8	Plate	Carbon steel	Nickel plated
9	Plate mounting bolt	Carbon steel	Nickel plated
10	Guide bolt	Carbon steel	Nickel plated
11	Retaining ring	Carbon tool steel	Phosphate coated
12	Retaining ring	Carbon tool steel	Phosphate coated
13	Bumper A	Urethane	
14	Bumper B	Urethane	
15	Magnet	—	
16	Hexagon socket head cap plug	Carbon steel	Nickel plated
17	Slide Bearing	Babbitt	
18	Felt	Felt	
19	Holder	Resin	
20	Ball bushing		
21	Spacer	Aluminum alloy	
22	Steel ball	Carbon steel	ø20 to ø50
23	Plug	Carbon steel	ø63 to ø100 Nickel plated
24*	Piston seal	NBR	
25*	Rod seal	NBR	
26*	Gasket A	NBR	
27*	Gasket B	NBR	

Component Parts

No.	Description	Material	Note
28	Piston gasket	NBR	ø32 to ø100 only
29	Lock bolt	Carbon steel	Zinc chromated
30	Lock holder	Brass	Electroless nickel plated
31	Lock piston	Carbon steel	Hard chrome plated
32	Lock spring	Stainless steel	
33	Seal retainer	Carbon steel	Zinc chromated (ø80, ø100 only)
34	Bumper	Urethane	
35*	Hexagon socket head cap screw	Carbon steel	Black zinc chromated
36*	Hexagon socket head cap screw	Carbon steel	Zinc chromated (ø50, ø63 only)
37	Cap A	Aluminum die-casted	Black painted
38	Cap B	Carbon steel	SQ treated
39	Rubber cap	Synthetic rubber	
40	M/O knob	Zinc die-casted	Black painted
41	M/O bolt	Alloy steel	Black zinc chromated
42	M/O spring	Steel wire	chromated
43	Stopper ring	Carbon steel	chromated
44*	Lock piston seal	NBR	
45*	Lock holder gasket	NBR	

Replacement Parts/Seal Kit

Bore size (mm)	Kit no.	Contents	Bore size (mm)	Kit no.	Contents
20	MGP20-B-PS	Set of nos. above	50	MGP50-B-PS	Set of nos. 24, 25, 26, 27, 35, 36, 37, 38, 39, 40, 41, 42, 43, 44, 45
25	MGP25-B-PS	Set of nos. above	63	MGP63-B-PS	Set of nos. 24, 25, 26, 27, 35, 36, 37, 38, 39, 40, 41, 42, 43, 44, 45
32	MGP32-B-PS	Set of nos. 24, 25, 26, 27, 35, 36, 37, 38, 39, 40, 41, 42, 43, 44, 45	80	MGP80-B-PS	Set of nos. 24, 25, 26, 27, 35, 36, 37, 38, 39, 40, 41, 42, 43, 44, 45
40	MGP40-B-PS	Set of nos. 24, 25, 26, 27, 35, 36, 37, 38, 39, 40, 41, 42, 43, 44, 45	100	MGP100-B-PS	Set of nos. 24, 25, 26, 27, 35, 36, 37, 38, 39, 40, 41, 42, 43, 44, 45

* Each seal kit includes the parts listed above. Order the seal kit based on each bore size.

* Since the seal kit does not include a grease pack, order it separately.

Grease pack part no.: GR-S-010 (10 g)

Construction/Series MGPL

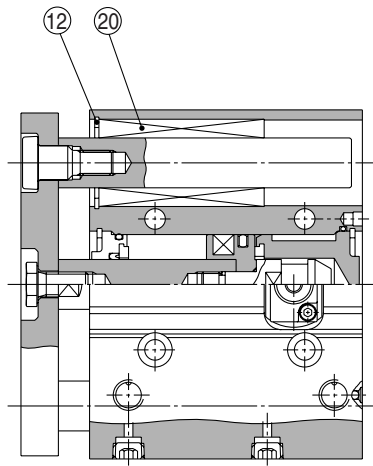

ø32 to ø63: 25 Stroke

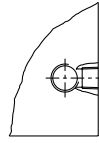

ø63 or more

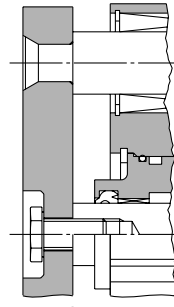

ø50 or more

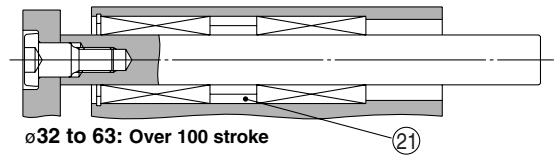

ø32 to 63: Over 100 stroke

Lock type

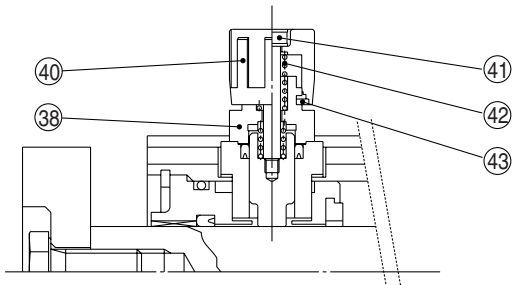

MGJ

MGP

MGQ

MGG

MGC

MGF

MGZ

MGT

D-□

-X□

Individual
-X□

Series MGP

Dimensions: $\phi 20$, $\phi 25$

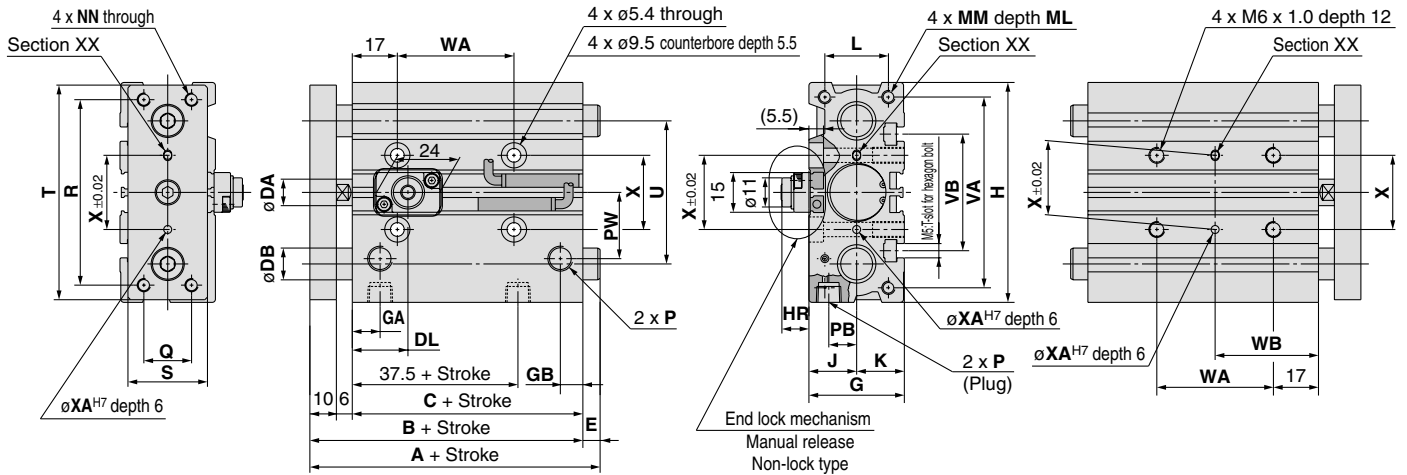

With rod end lock

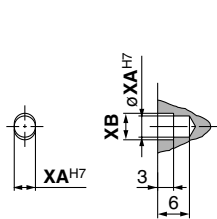

Detailed figure of section XX

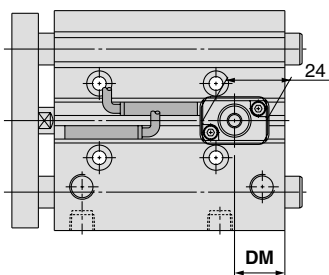

With head end lock

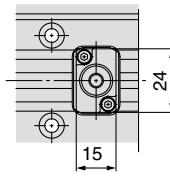

$\phi 25$

End lock mechanism (Manual release lock type)

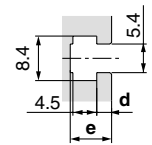
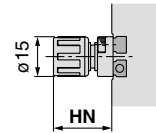

T-slot dimensions (mm)

Bore size (mm)	T-slot dimensions	
	d	e
20	2.8	7.8
25	3	8.2

• For intermediate strokes other than standard strokes, refer to the Manufacture of Intermediate Stroke on page 309.

• Rc, NPT and G ports can be selected. (Refer to page 308.)

MGPM, MGPL Common Dimensions

Bore size (mm)	Standard stroke (mm)	B	C	DA	G	GA	GB	H	J	K	L	MM	ML	NN	P			PB	PW	Q	R	S
															Nil	N	TF					
20	25, 50, 75, 100, 125, 150, 175, 200, 250	78	62	10	36	10.5	8.5	83	18	18	24	M5 x 0.8	13	M5 x 0.8	Rc 1/8	NPT 1/8	G 1/8	10.5	25	18	70	30
25	300, 350, 400	78.5	62.5	12	42	11.5	9	93	21	21	30	M6 x 1.0	15	M6 x 1.0	Rc 1/8	NPT 1/8	G 1/8	13.5	30	26	78	38

Bore size (mm)	T	U	VA	VB	WA				WB				X	XA	XB
					75 st or less	Over 75 st to 175 st	Over 175 st to 250 st	Over 250 st	75 st or less	Over 75 st to 175 st	Over 175 st to 250 st	Over 250 st			
20	81	54	72	44	44	120	200	300	39	77	117	167	28	3	3.5
25	91	64	82	50	44	120	200	300	39	77	117	167	34	4	4.5

MGPM (Slide bearing) A, DB, E Dimensions (mm)

Bore size (mm)	A			DB	E		
	25 st or less	Over 25 st to 175 st	Over 175 st		25 st or less	Over 25 st to 175 st	Over 175 st
20	78	84.5	122	12	0	6.5	44
25	78.5	85	122	16	0	6.5	43.5

MGPL (Ball bushing bearing) A, DB, E Dimensions (mm)

Bore size (mm)	A			DB	E		
	75 st or less	Over 75 st to 175 st	Over 175 st		75 st or less	Over 75 st to 175 st	Over 175 st
20	80	104	122	10	2	26	44
25	85.5	104.5	122	13	7	26	43.5

End Lock Mechanism Dimensions (mm)

Bore size (mm)	DL	DM	HR	HN
20	21	19	10.5	22
25	26.5	16	8	19.5

Dimensions: $\phi 32$ to $\phi 63$

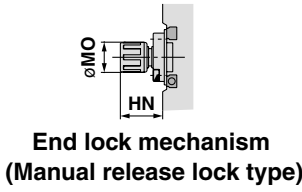
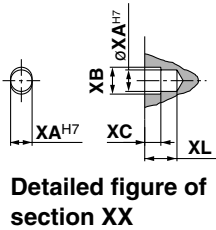
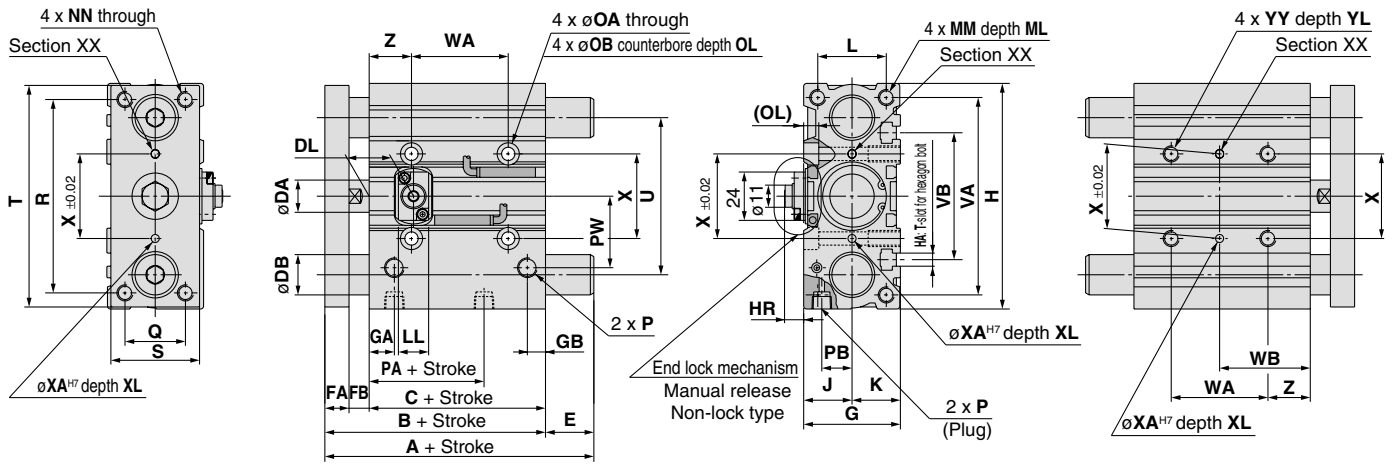

T-slot dimensions (mm)

Bore size (mm)	T-slot dimensions				
	a	b	c	d	e
32	6.5	10.5	5.5	3.5	9.5
40	6.5	10.5	5.5	4	11
50	8.5	13.5	7.5	4.5	13.5
63	11	17.8	10	7	18.5

• For intermediate strokes other than standard strokes, refer to the Manufacture of Intermediate Stroke on page 309.

• Rc, NPT and G ports can be selected. (Refer to page 308.)

MGPM, MGPL Common Dimensions

Bore size (mm)	Standard stroke (mm)	B	C	DA	FA	FB	G	GA	GB	H	HA	J	K	L	MM	ML	NN	OA	OB	OL	P		
		Nil	N	TF																			
32	25, 50, 75	84.5	62.5	16	12	10	48	12.5	9	112	M6	24	24	34	M8 x 1.25	20	M8 x 1.25	6.6	11	7.5	Rc1/8	NPT1/8	G1/8
40	100, 125, 150	91	69	16	12	10	54	14	10	120	M6	27	27	40	M8 x 1.25	20	M8 x 1.25	6.6	11	7.5	Rc1/8	NPT1/8	G1/8
50	175, 200, 250	97	69	20	16	12	64	14	11	148	M8	32	32	46	M10 x 1.5	22	M10 x 1.5	8.6	14	9	Rc1/4	NPT1/4	G1/4
63	300, 350, 400	102	74	20	16	12	78	16.5	13.5	162	M10	39	39	58	M10 x 1.5	22	M10 x 1.5	8.6	14	9	Rc1/4	NPT1/4	G1/4

Bore size (mm)	PA	PB	PW	Q	R	S	T	U	VA	VB	WA				WB				X	XA	XB	XC	XL	YY	YL	Z
	75 st or less	Over 75 st to 175 st	Over 175 st	75 st or less	Over 75 st to 175 st	Over 175 st to 250 st	Over 250 st	75 st or less	Over 75 st to 175 st	Over 175 st to 250 st	Over 250 st	75 st or less	Over 75 st to 175 st	Over 175 st to 250 st	Over 250 st	X	XA	XB	XC	XL	YY	YL	Z			
32	32	15	35.5	30	96	44	110	78	98	63	48	124	200	300	45	83	121	171	42	4	4.5	3	6	M8 x 1.25	16	21
40	38	18	39.5	30	104	44	118	86	106	72	48	124	200	300	46	84	122	172	50	4	4.5	3	6	M8 x 1.25	16	22
50	34	21.5	47	40	130	60	146	110	130	92	48	124	200	300	48	86	124	174	66	5	6	4	8	M10 x 1.5	20	24
63	39	28	58	50	130	70	158	124	142	110	52	128	200	300	50	88	124	174	80	5	6	4	8	M10 x 1.5	20	24

MGPM (Slide bearing) A, DB, E Dimensions (mm)

Bore size (mm)	A			DB	E		
	25 st or less	Over 25 st to 175 st	Over 175 st		25 st or less	Over 25 st to 175 st	Over 175 st
32	97	102	140	20	12.5	17.5	55.5
40	97	102	140	20	6	11	49
50	106.5	118	161	25	9.5	21	64
63	106.5	118	161	25	4.5	16	59

MGPL (Ball bushing bearing) A, DB, E Dimensions (mm)

Bore size (mm)	A				DB	E			
	25 st or less	Over 25 st to 75 st	Over 75 st to 175 st	Over 175 st		25 st or less	Over 25 st to 75 st	Over 75 st to 175 st	Over 175 st
32	84.5	98	118	140	16	0	13.5	33.5	55.5
40	91	98	118	140	16	0	7	27	49
50	97	114	134	161	20	0	17	37	64
63	102	114	134	161	20	0	12	32	59

End Lock Mechanism Dimensions (mm)

Bore size (mm)	DL	DM	HR	HN	LL	MO
32	22	22	9.5	21	15	15
40	26	23	11.5	25.5	21	19
50	24	23	13	27	21	19
63	25	25.5	11	25	21	19

MGJ
MGP
MGQ
MGG
MGC
MGF
MGZ
MGT

D-□
-X□
Individual
-X□

Series MGP

Dimensions: $\phi 80, \phi 100$

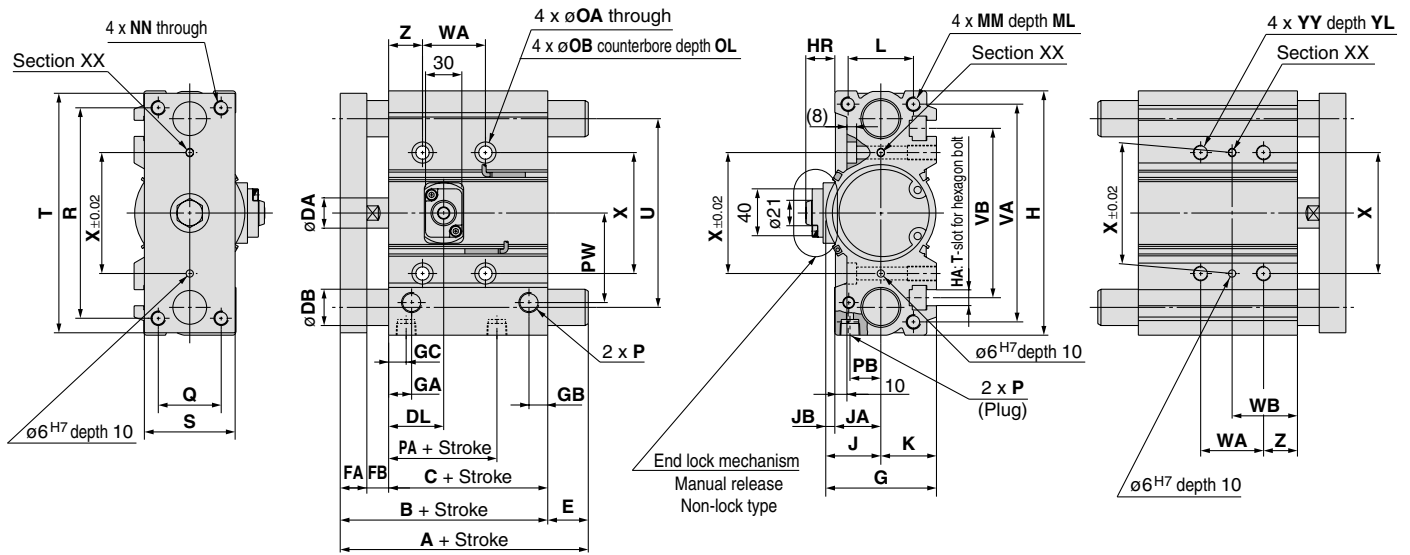

With rod end lock

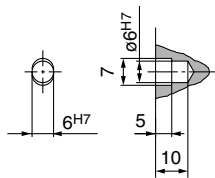

Detailed figure of section XX

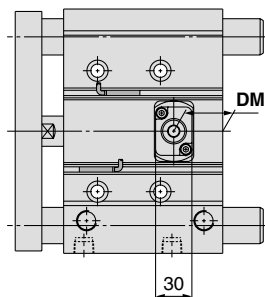

With head end lock

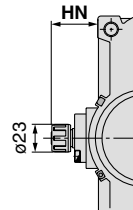

End lock mechanism (Manual release lock type)

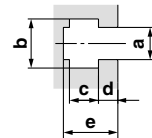

T-slot dimensions (mm)

Bore size (mm)	T-slot dimensions				
	a	b	c	d	e
80	13.3	20.3	12	8	22.5
100	15.3	23.3	13.5	10	30

• For intermediate strokes other than standard strokes, refer to the Manufacture of Intermediate Stroke on page 309.

• Rc, NPT and G ports can be selected. (Refer to page 308.)

MGPM, MGPL Common Dimensions

Bore size (mm)	Standard stroke (mm)	B	C	DA	FA	FB	G	GA	GB	GC	H	HA	J	JA	JB	K	L	MM	ML	NN	OA	OB
		80	25, 50, 75, 100, 125, 150, 175, 200, 250	146.5	106.5	25	22	18	91.5	19	15.5	14.5	202	M12	45.5	38	7.5	46	54	M12 x 1.75	25	M12 x 1.75
100	300, 350, 400	166	116	30	25	25	111.5	23	19	18	240	M14	55.5	45	10.5	56	62	M14 x 2.0	31	M14 x 2.0	12.5	20

Bore size (mm)	P			PA	PB	PW	Q	R	S	T	U	VA	VB	WA				WB				X	YY	YL	Z
	Nil	N	TF											50 st or less	Over 50 st to 150 st	Over 150 st to 250 st	Over 250 st	50 st or less	Over 50 st to 150 st	Over 150 st to 250 st	Over 250 st				
80	Rc3/8	NPT3/8	G3/8	64.5	25.5	74	52	174	75	198	156	180	140	52	128	200	300	54	92	128	178	100	M12 x 1.75	24	28
100	Rc3/8	NPT3/8	G3/8	67.5	32.5	89	64	210	90	236	188	210	166	72	148	220	320	47	85	121	171	124	M14 x 2.0	28	11

MGPM (Slide bearing) A, DB, E Dimensions (mm)

Bore size (mm)	A		DB	E	
	150 st or less	Over 150 st		150 st or less	Over 150 st
80	146.5	193	30	0	46.5
100	166	203	36	0	37

MGPL (Ball bushing bearing) A, DB, E Dimensions (mm)

Bore size (mm)	A		DB	E	
	150 st or less	Over 150 st		150 st or less	Over 150 st
80	160	193	25	13.5	46.5
100	180	203	30	14	37

End Lock Mechanism Dimensions (mm)

Bore size (mm)	DL	DM	HR	HN
80	45.5	40.5	24	38.5
100	49	43.5	26.5	41



Series MGP With End Lock Specific Product Precautions

Be sure to read before handling. Refer to front matters 42 and 43 for Safety Instructions and pages 3 to 11 for Actuator and Auto Switch Precautions.

Use the Recommended Pneumatic Circuit

Caution

- This is necessary for the correct locking and unlocking actions.

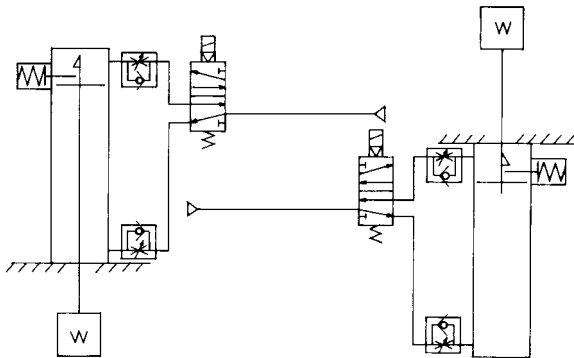

Head end lock

Rod end lock

Operating Precautions

Caution

- Do not use 3 position solenoid valves.**
Avoid use in combination with 3 position solenoid valves (especially closed center metal seal types). If pressure is trapped in the port on the lock mechanism side, the cylinder cannot be locked. Furthermore, even after being locked, the lock may be released after some time, due to air leaking from the solenoid valve and entering the cylinder.
- Back pressure is required when releasing the lock.**
Before starting operation, be sure to control the system so that air is supplied to the side without the lock mechanism as shown in the figure above. There is a possibility that the lock may not be released. (Refer to the section on releasing the lock.)
- Release the lock when mounting or adjusting the cylinder.**
If mounting or other work is performed when the cylinder is locked, the lock unit may be damaged.
- Operate with a load ratio of 50% or less.**
If the load ratio exceeds 50%, this may cause problems such as failure of the lock to release, or damage to the lock unit.
- Do not operate multiple cylinders in synchronization.**
Avoid applications in which two or more end lock cylinders are synchronized to move one workpiece, as one of the cylinder locks may not be able to release when required.
- Use a speed controller with meter-out control.**
Lock cannot be released occasionally by meter-in control.
- Be sure to operate completely to the cylinder stroke end on the side with the lock.**
If the cylinder piston does not reach the end of the stroke, locking and unlocking may not be possible.
- Do not use an air cylinder as an air-hydro cylinder. This will cause leakage of hydraulic fluid.**
- Adjust an auto switch's position so that it operates for movement to both the stroke and backlash (2 mm) positions.**
When a 2-color indication switch is adjusted for green indication at the stroke end, it may change to red for the backlash return, but this is not abnormal.

Operating Pressure

Caution

1. Supply air pressure of 0.15 MPa or higher to the port on the side that has the lock mechanism, as it is necessary for disengaging the lock.

Exhaust Speed

Caution

1. When the pressure on the side with the lock mechanism drops to 0.05 MPa or below, the lock engages automatically. If the piping on the side with the lock mechanism is thin and long, or if the speed controller is away from the cylinder port, the lock engagement may take some due to decline of the exhaust speed. The same result will be caused by clogging of the silencer installed at the EXH port of the solenoid valve.

Releasing the Lock

Warning

1. Before releasing the lock, be sure to supply air to the side without the lock mechanism, so that there is no load applied to the lock mechanism when it is released. (Refer to the Recommended pneumatic circuits.) If the lock is released when the port on the other side is in an exhaust state, and with a load applied to the lock unit, the lock unit may be subjected to an excessive force and be damaged. Also, it is very dangerous because the piston rod will be rushed to move.

Manual Release

Caution

1. Manual release (Non-lock type)

Insert the accessory bolt from the top of the rubber cap (it is not necessary to remove the rubber cap), and after screwing it into the lock piston, pull it to release the lock. If you stop pulling the bolt, the lock will return to an operational state.

Thread sizes, pulling forces and strokes are as shown below.

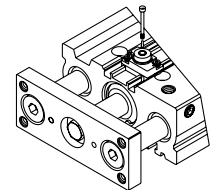

Bore size (mm)	Thread size	Pulling force	Stroke (mm)
20, 25, 32	M2.5 x 0.45 x 25ℓ or more	4.9 N	2
40, 50, 63	M3 x 0.5 x 30ℓ or more	10 N	3
80, 100	M5 x 0.8 x 40ℓ or more	24.5 N	3

Remove the bolt for normal operation.

It can cause lock malfunction or faulty release.

2. Manual release, Lock type

While pushing the M/O knob, turn it 90° counterclockwise. The lock is released (and remains in a released state) by aligning the ▲ mark on the cap with the ▼ OFF mark on the M/O knob.

When locking is desired, turn M/O button clockwise 90° while pushing fully, correspond ▲ on cap and ▼ ON mark on M/O button. The correct position is confirmed by a click sound "click". If not confirmed, locking is not done.

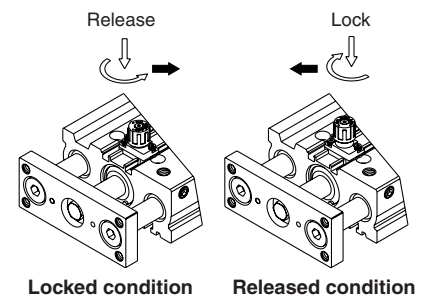

Locked condition

Released condition

MGJ

MGP

MGQ

MGG

MGC

MGF

MGZ

MGT

D-□

-X□

Individual
-X□

Compact Guide Cylinder/Heavy Duty Guide Rod Type

Series *MGPS*

ø50, ø80

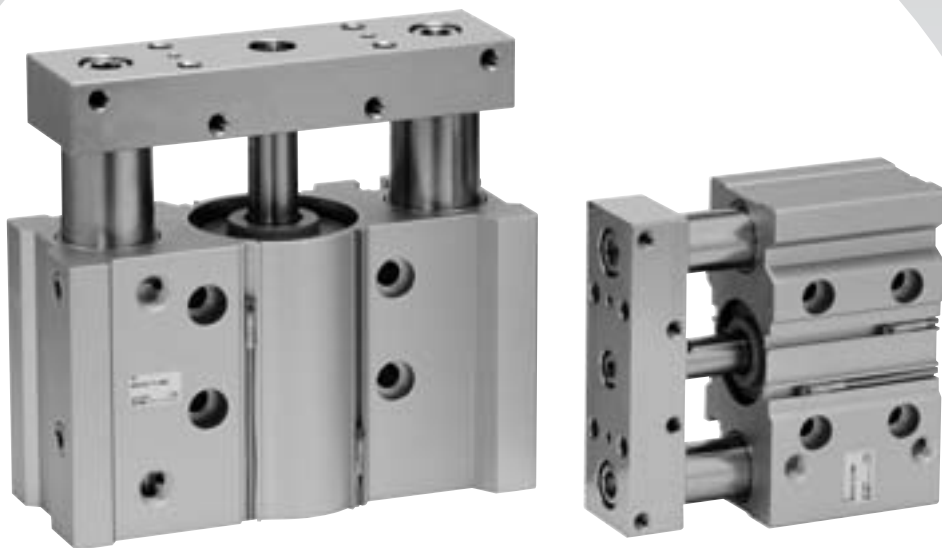

MGJ

MGP

MGQ

MGG

MGK

MGF

MGZ

MGT

Stroke Variations

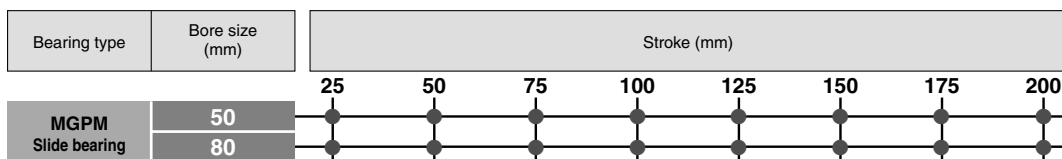

D-□

-X□

Individual
-X□

Compact Guide Cylinder/ Heavy Duty Guide Rod Type Series **MGPS** ø50, ø80

How to Order

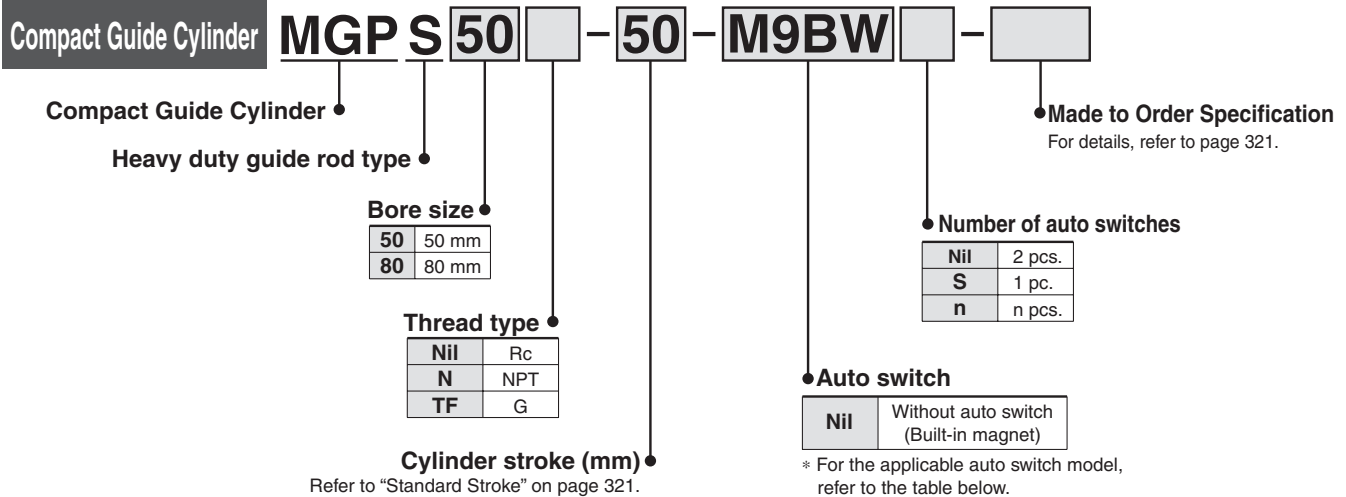

Applicable Auto Switch/Refer to pages 1719 to 1827 for further information on auto switches.

Type	Special function	Electrical entry	Indicator light	Wiring (Output)	Load voltage		Auto switch model		Lead wire length (m)				Pre-wired connector	Applicable load						
					DC	AC	Perpendicular	In-line	0.5 (Nil)	1 (M)	3 (L)	5 (Z)		IC circuit	Relay, PLC					
Solid state switch	—	Grommet	Yes	3-wire (NPN)	24V	5V, 12V	—	M9NV	M9N	●	●	●	○			○	IC circuit	Relay, PLC		
				3-wire (PNP)				M9PV	M9P	●	●	●	○	○						
	Diagnostic indication (2-color indication)			2-wire	5V, 12V	M9BV	M9B	●	●	●	○	○	○	○	—					
				3-wire (NPN)		M9NWV	M9NW	●	●	●	○	○	○	○	IC circuit					
	Water resistant (2-color indication)			3-wire (PNP)	5V, 12V	M9PWV	M9PW	●	●	●	○	○	○	○	IC circuit					
				2-wire		M9BWV	M9BW	●	●	●	○	○	○	○	—					
	Magnetic field resistant (2-color indication)			3-wire (NPN)	5V, 12V	M9NAV**	M9NA**	○	○	●	○	○	○	○	IC circuit					
				3-wire (PNP)		M9PAV**	M9PA**	○	○	●	○	○	○	○	IC circuit					
	Reed switch			—	Grommet	Yes	2-wire (Non-polar)	24V	12V	100V 100V or less	M9BAV**	M9BA**	○	○	●	○	○		○	—
							—				P3DW	●	—	●	●	○	○		—	
—		P4DW	—				—				●	●	○	○	—					
—		—	—				—				—	—	—	—	—	—				
Reed switch	—	Grommet	No	3-wire (NPN equivalent)	24V	12V	100V 100V or less	A96V	A96	●	—	●	—	—	—	IC circuit				
				2-wire				A93V	A93	●	—	●	—	—	—	—	Relay, PLC			
				2-wire				A90V	A90	●	—	●	—	—	—	—	IC circuit			

** Water resistant type auto switches can be mounted on the above models, but in such case SMC cannot guarantee water resistance. Consult with SMC regarding water resistant types with the above model numbers.

* Lead wire length symbols: 0.5 m..... Nil (Example) M9NW
1 m..... M (Example) M9NWM
3 m..... L (Example) M9NWL
5 m..... Z (Example) M9NWX

* Solid state auto switches marked with "○" are produced upon receipt of order.

* Since there are other applicable auto switches than listed, refer to page 336 for details.
* For details about auto switches with pre-wired connector, refer to pages 1784 and 1785. For D-P3DW□, refer to pages 1773-1 and 1773-2.
* Auto switches are shipped together (not assembled).

Compact Guide Cylinder Heavy Duty Guide Rod Type *Series MGPS*

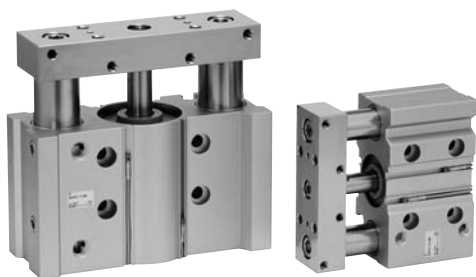

Specifications

Bore size	ø50	ø80
Action	Double acting	
Fluid	Air	
Proof pressure	1.5 MPa	
Maximum operating pressure	1.0 MPa	
Minimum operating pressure	0.1 MPa	
Ambient and fluid temperature	-10 to 60°C (No freezing)	
Piston speed	50 to 400 mm/s	
Cushion	Rubber bumper on both ends	
Lubrication	Not required (Non-lube)	
Stroke length tolerance	$+1.5$ 0 mm	

Standard Stroke

Bore size (mm)	Standard stroke (mm)
50, 80	25, 50, 75, 100, 125, 150, 175, 200

Manufacture of Intermediate Stroke

Description	Spacer installation type Spacers are installed in the standard stroke cylinder. Available by the 5 mm stroke interval.
Part no.	Refer to "How to Order" for the standard model numbers on page 320.
Applicable stroke (mm)	5 to 195
Example	Part no.: MGPS50-35 A spacer 15 mm in width is installed in a MGPS50-50. C dimension is 94 mm.

Note) Intermediate stroke (by the 1 mm interval) based on an exclusive body will be available upon request for special.

Theoretical Output

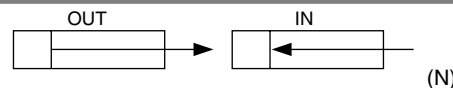

Bore size (mm)	Rod size (mm)	Operating direction	Piston area (mm ²)	Operating pressure (MPa)									
				0.2	0.3	0.4	0.5	0.6	0.7	0.8	0.9	1.0	
50	20	OUT	1963	393	589	785	982	1178	1374	1571	1767	1963	
		IN	1649	330	495	660	825	990	1155	1319	1484	1649	
80	25	OUT	5027	1005	1508	2011	2513	3016	3519	4021	4524	5027	
		IN	4536	907	1361	1814	2268	2721	3175	3629	4082	4536	

Note) Theoretical output (N) = Pressure (MPa) x Piston area (mm²)

Mass

Bore size (mm)	Model	Standard stroke (mm)								
		25	50	75	100	125	150	175	200	
50	MGPS50	3.90	4.68	5.74	6.52	7.30	8.08	8.86	9.64	
80	MGPS80	9.21	10.7	13.0	14.5	15.9	17.9	18.9	20.3	

Allowable Rotational Torque of Plate

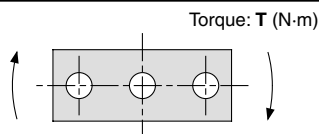

Bore size (mm)	Model	Standard stroke (mm)								
		25	50	75	100	125	150	175	200	
50	MGPS50	15	12	16	15	13	12	11	9.8	
80	MGPS80	49	41	51	45	41	38	35	32	

Non-rotating Accuracy of Plate

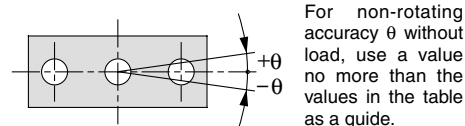

For non-rotating accuracy θ without load, use a value no more than the values in the table as a guide.

Bore size (mm)	Model	Non-rotating accuracy θ
50	MGPS50	$\pm 0.05^\circ$
80	MGPS80	$\pm 0.04^\circ$



Made to Order Specifications (For details, refer to page 1995.)

Symbol	Specifications
—X867	Lateral piping type (Change of plug position)

Refer to pages 334 to 336 for cylinders with auto switches.

- Minimum auto switch mounting stroke
- Proper auto switch mounting position (detection at stroke end) and mounting height
- Operating range
- Auto switch mounting bracket: Part no.

MGJ

MGP

MGQ

MGG

MGC

MGF

MGZ

MGT

D-□

-X□

Individual
-X□

Series MGPS Model Selection

Selection Conditions

Mounting orientation	Vertical		Horizontal	
Maximum speed (mm/s)	200 or less	400	200 or less	400
Graph (Slide bearing type)	(1), (2)	(3), (4)	(5), (6)	(7), (8)

Selection Example 1 (Vertical Mounting)

Selection conditions

Mounting: Vertical
Stroke: 50 stroke
Maximum speed: 200 mm/s
Load mass: 100 kg
Eccentric distance: 100 mm

Find the point of intersection for the load mass of 100 kg and the eccentric distance of 100 mm on graph 1, based on vertical mounting, 50 mm stroke, and the speed of 200 mm/s.

→MGPS80-50 is selected.

(1) 50 stroke or less, $V = 200$ mm/s or less

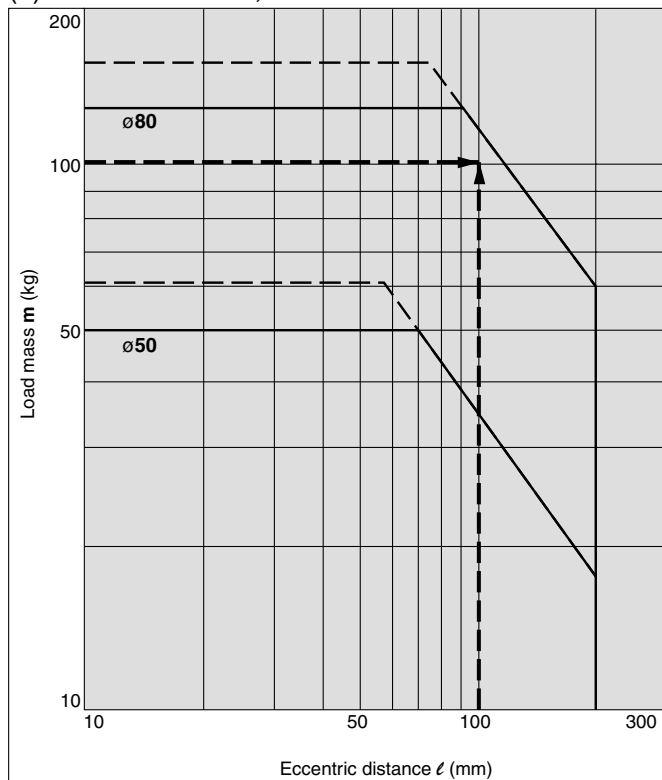

· When the maximum speed exceeds 200 mm/s, the allowable load mass is determined by multiplying the value shown in the graph at 400 mm/s by the coefficient listed in the table below.

Maximum	Up to 300 mm/s	Up to 400 mm/s	Up to 500 mm/s
Coefficient	1.7	1	0.6

· Use the "Guide Cylinder Selection Software", when the eccentric distance is 200 mm or more.

Selection Example 2 (Horizontal Mounting)

Selection conditions

Mounting: Horizontal
Distance between plate and load center of gravity: 50 mm
Maximum speed: 200 mm/s
Load mass: 30 kg
Stroke: 100 stroke

Find the point of intersection for the load mass of 30 kg and 100 stroke on graph 5, based on horizontal mounting, the distance of 50 mm between the plate and load center of gravity, and the speed of 200 mm/s.

→MGPS80-100 is selected.

(5) $l = 50$ mm, $V = 200$ mm/s or less

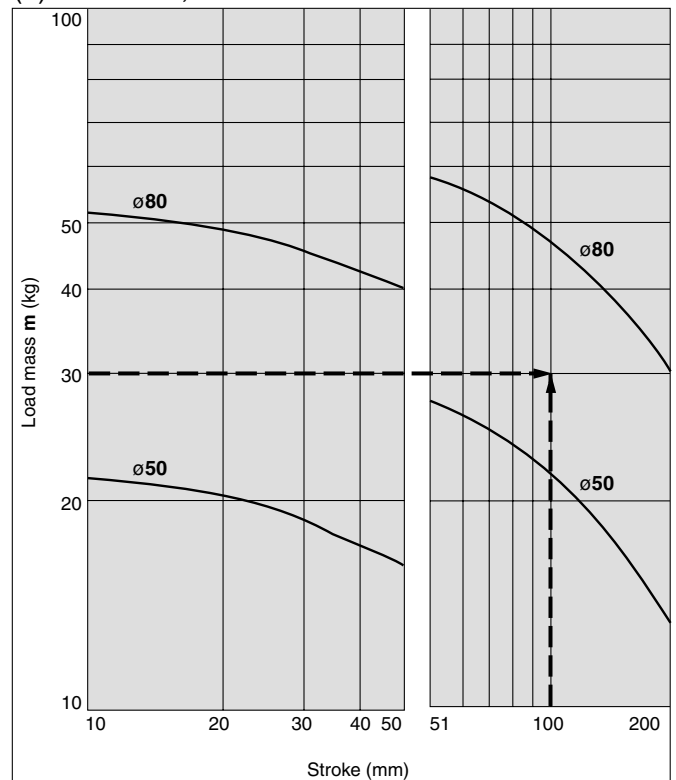

Vertical Mounting (Slide Bearing)

— Operating pressure 0.4 MPa
- - - Operating pressure 0.5 MPa or more

MGPS50, 80

(1) 50 Stroke or Less, V = 200 mm/s or less

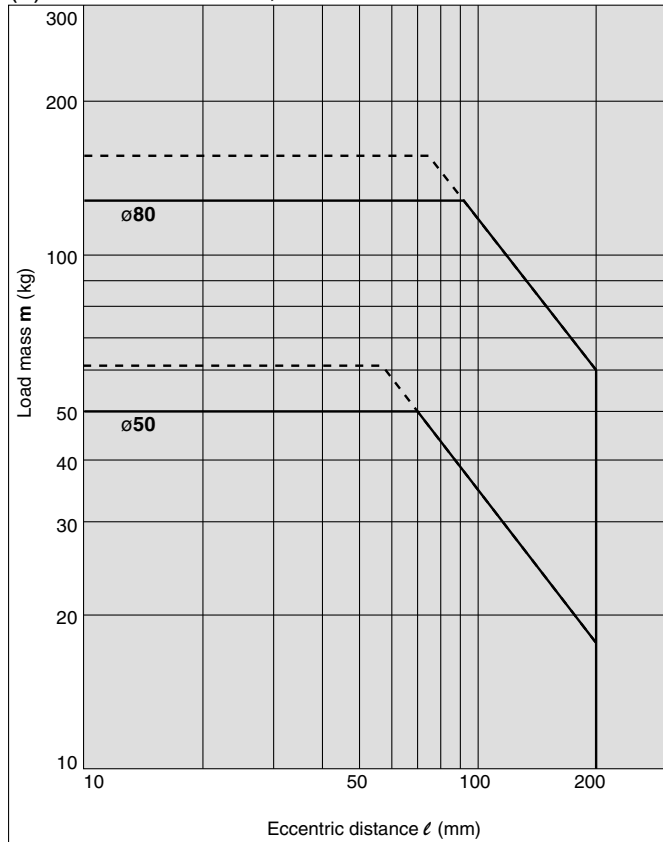

(2) Over 50 Stroke, V = 200 mm/s or less

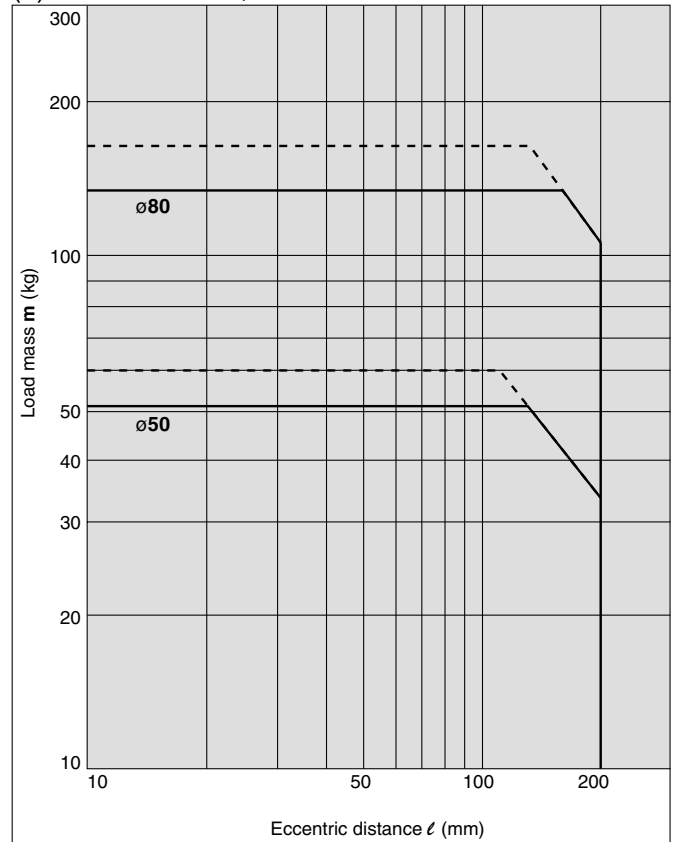

(3) 50 Stroke or Less, V = 400 mm/s

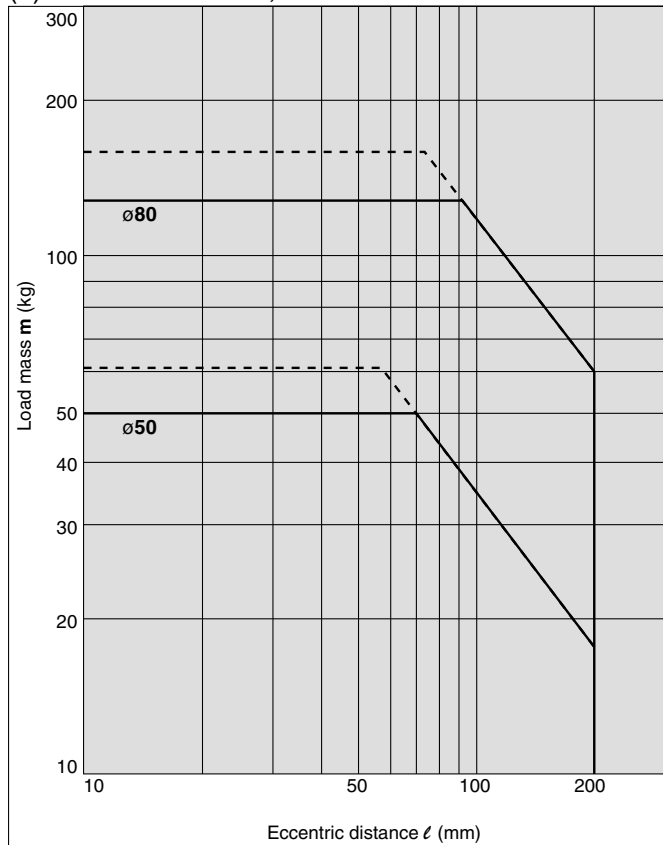

(4) Over 50 Stroke, V = 400 mm/s

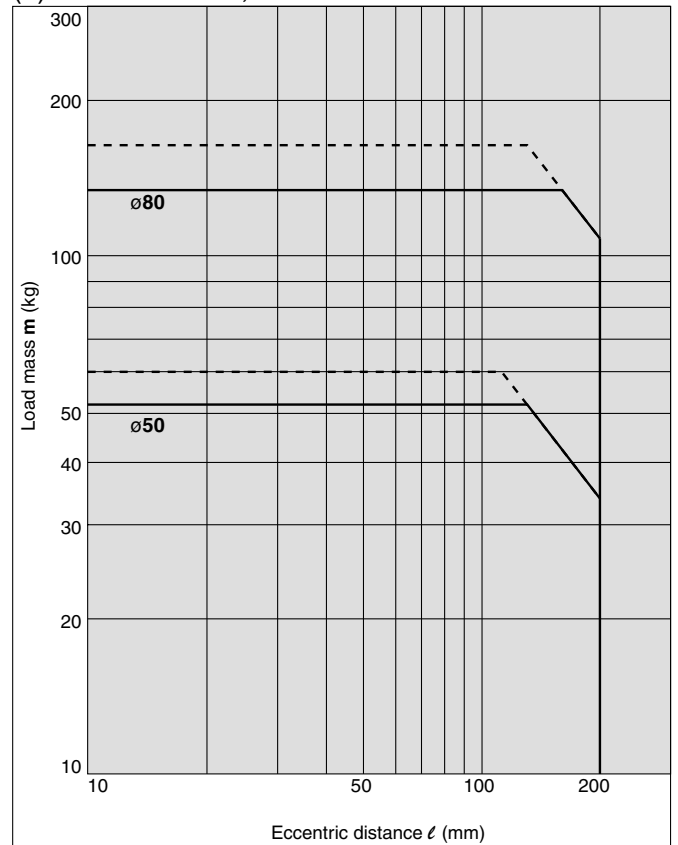

- MGJ
- MGP
- MGQ
- MGG
- MGC
- MGF
- MGZ
- MGT

- D-
- X
- Individual
 -X

· Use the "Guide Cylinder Selection Software", when the eccentric distance is 200 mm or more.

Series MGPS

Horizontal Mounting (Slide Bearing)

MGPS50, 80

(5) $\ell = 50$ mm, $V = 200$ mm/s or less

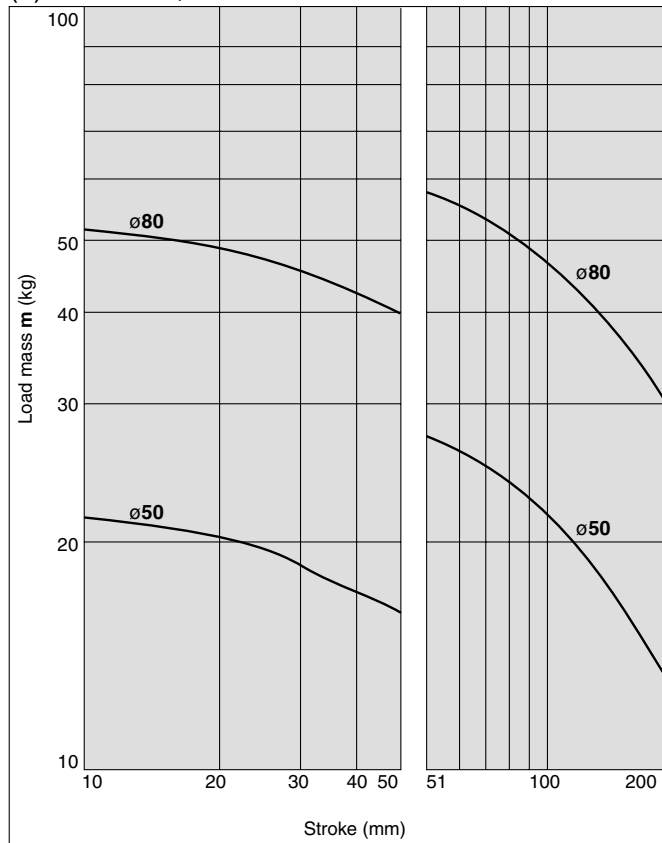

(6) $\ell = 100$ mm, $V = 200$ mm/s or less

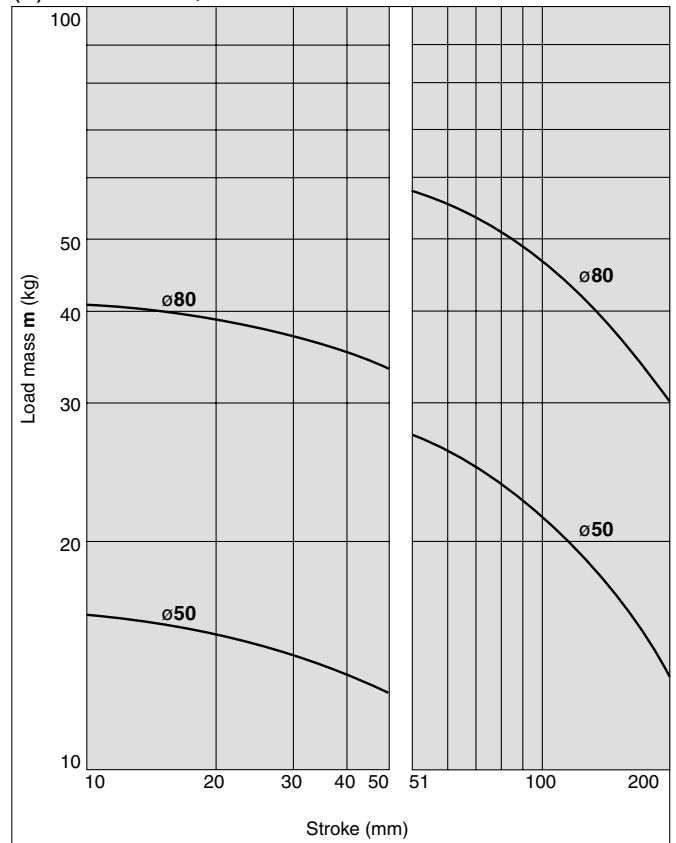

(7) $\ell = 50$ mm, $V = 400$ mm/s

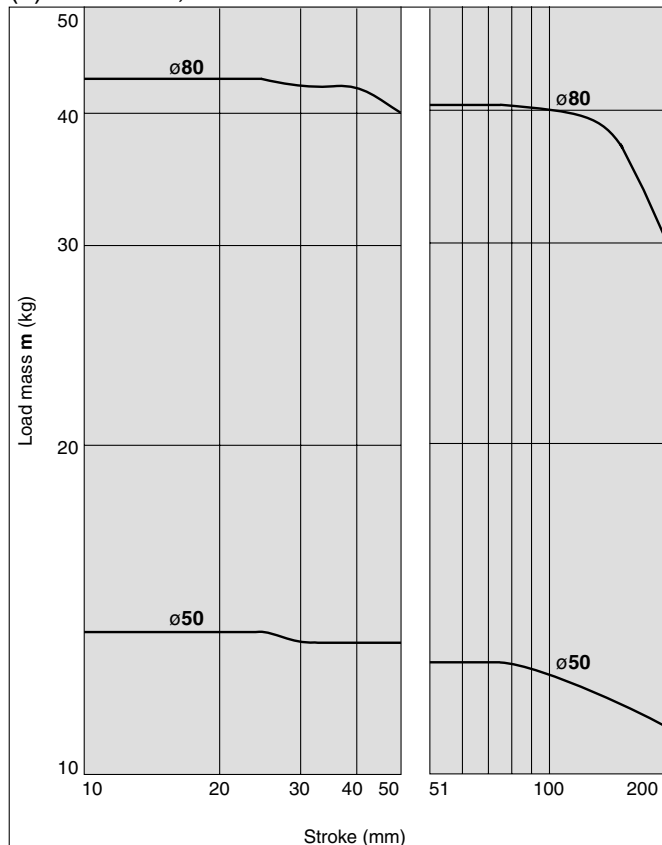

(8) $\ell = 100$ mm, $V = 400$ mm/s

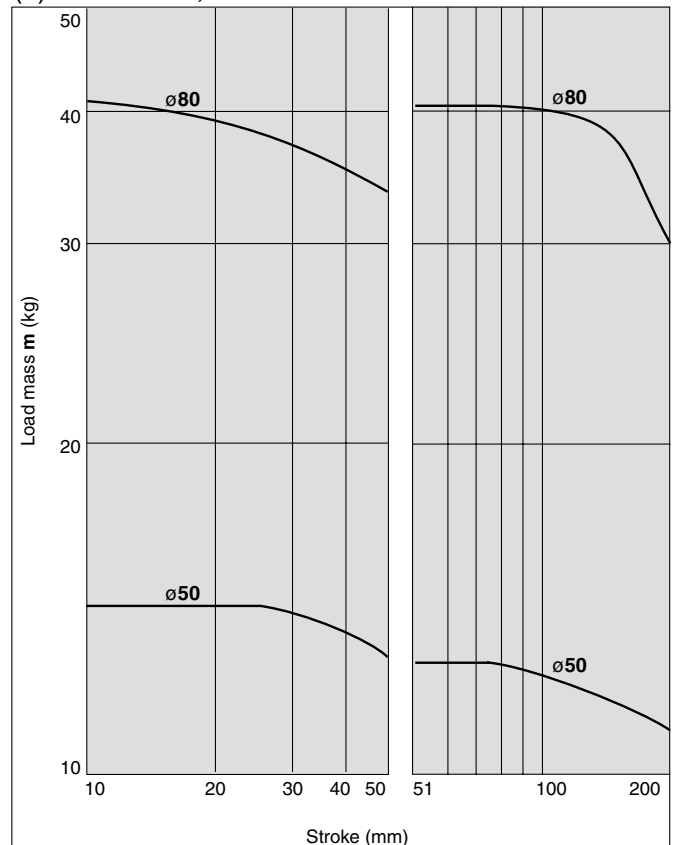

Operating Range when Used as Stopper

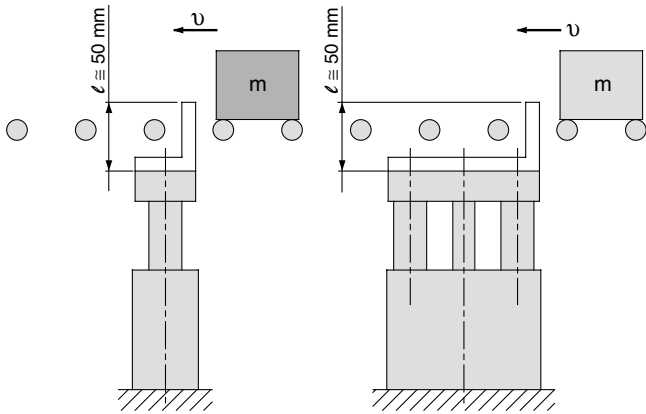

* When selecting a model with a longer l dimension, be sure to choose a bore size which is sufficiently large.

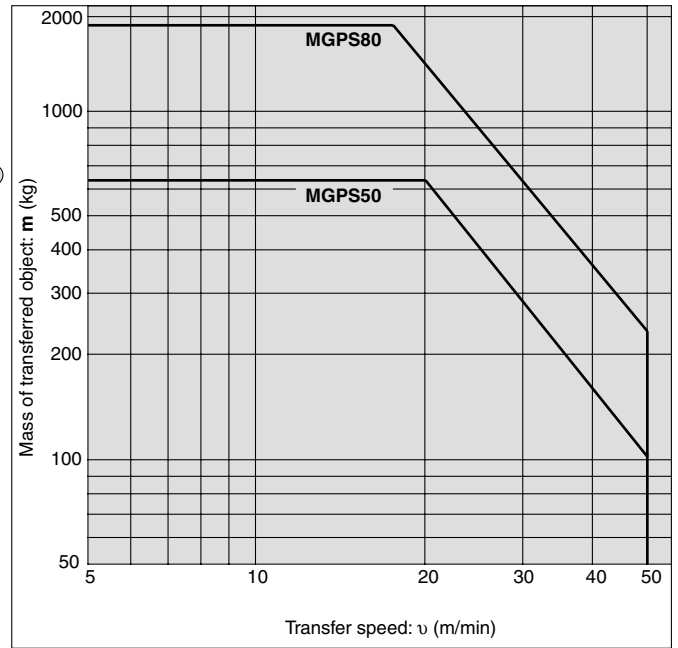

Caution

Caution on handling

Note) When using as a stopper, select a model with 50 stroke or less.

MGJ

MGP

MGQ

MGG

MGC

MGF

MGZ

MGT

D-□

-X□

Individual
-X□

Series MGPS

Construction

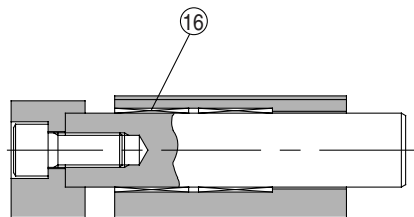

Over 50 stroke

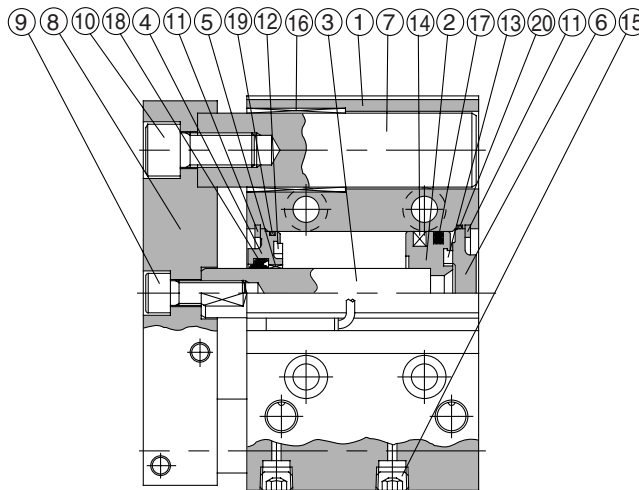

50 stroke or less

Component Parts

No.	Description	Material	Note	
1	Body	Aluminum alloy	Hard anodized	
2	Piston	Aluminum alloy	Chromated	
3	Piston rod	Carbon steel	Hard chrome plated	
4	Collar	Aluminum alloy casted	Painted	
5	Bushing	Babbitt		
6	Head cover	Aluminum alloy	ø50	Chromated
			ø80	Painted
7	Guide rod	Carbon steel	Hard chrome plated	
8	Plate	Carbon steel	Nickel plated	
9	Plate mounting bolt A	Carbon steel	Nickel plated	For piston rod
10	Plate mounting bolt B	Carbon steel	Nickel plated	For guide rod

Component Parts

No.	Description	Material	Note
11	Retaining ring	Carbon tool steel	Phosphate coated
12	Bumper A	Urethane	
13	Bumper B	Urethane	
14	Magnet	—	
15	Hexagon socket head taper plug	Carbon steel	Nickel plated
16	Slide Bearing	Babbitt	
17*	Piston seal	NBR	
18*	Rod seal	NBR	
19*	Gasket A	NBR	
20*	Gasket B	NBR	

Replacement Parts/Seal Kit

Bore size (mm)	Kit no.	Contents
50	MGP50-PS	Set of nos. above ⑰, ⑱, ⑲, ⑳.
80	MGP80-PS	

* Seal kit includes ⑰ to ⑳. Order the seal kit, based on each bore size.

* Since the seal kit does not include a grease pack, order it separately.

Grease pack part no.: GR-S-010 (10 g)

Compact Guide Cylinder Heavy Duty Guide Rod Type *Series MGPS*

Dimensions

MGPS50, 80

T-slot dimensions

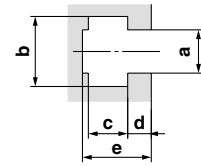
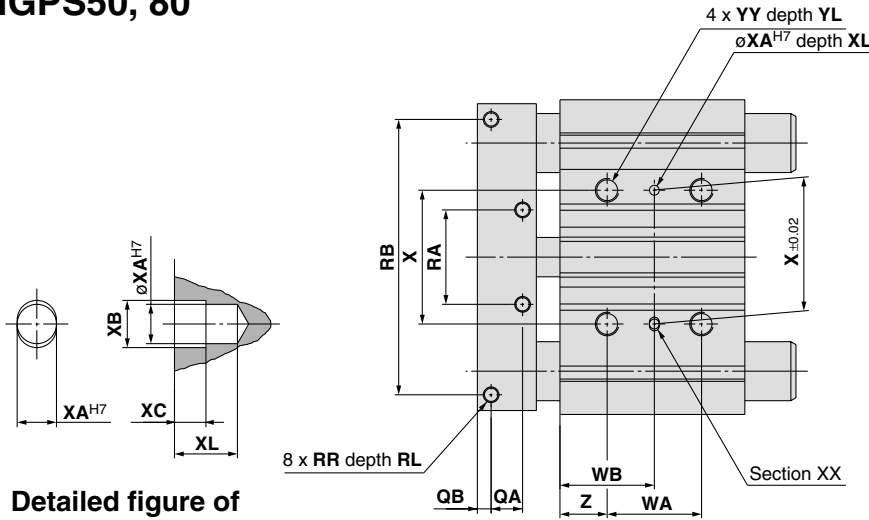

Bore size (mm)	T-slot dimensions (mm)				
	a	b	c	d	e
50	11	17.8	10	6	17.5
80	13.3	20.3	12	8	22.5

Detailed figure of XX section

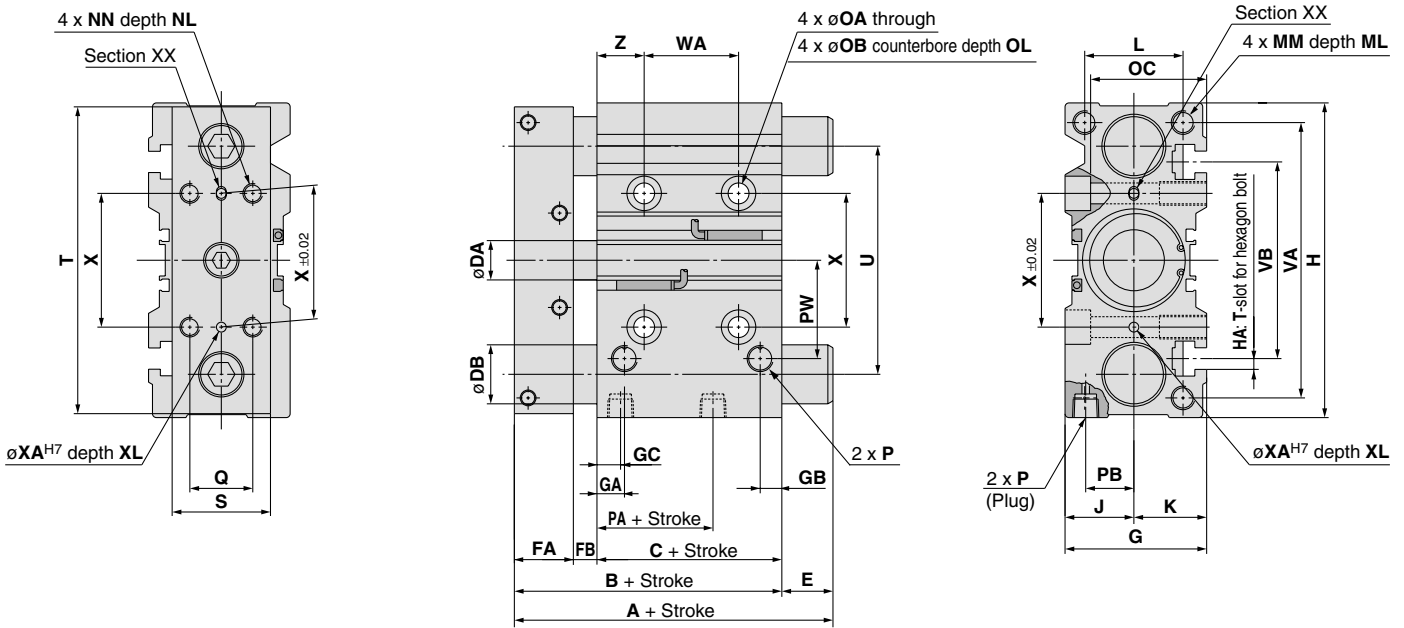

- MGJ
- MGP
- MGQ
- MGG
- MGC
- MGF
- MGZ
- MGT

For intermediate strokes other than standard strokes, refer to "Manufacture of Intermediate Stroke" on page 321.

Dimensions

Bore size (mm)	Standard stroke (mm)	A		B	C	DA	DB	E		FA	FB	G	GA	GB	GC	H	HA	J	K	L
		25, 50 st	Over 50 st					25, 50 st	Over 50 st											
50	25, 50, 75, 100	86	110	86	44	20	30	0	24	30	12	72	14	11	12	160	M10	35	37	50
80	125, 150, 175, 200	118	151	118	65	25	45	0	33	35	18	95	19	24	14.5	242	M12	47	48	66

Bore size (mm)	MM	ML	NN	NL	OA	OB	OC	OL	P			PA	PB	PW	Q	QA	QB	RA	RB	RR
									Nil	N	TF									
50	M12 x 1.75	20	M10 x 1.5	20	10.6	17.5	59	13	Rc 1/4	NPT 1/4	G 1/4	9	24.5	50	32	16	7	48	140	M8 x 1.25
80	M16 x 2.0	32	M12 x 1.75	24	12.5	20	72	17.5	Rc 3/8	NPT 3/8	G 3/8	14.5	29	77	40	18	9	80	200	M10 x 1.5

Bore size (mm)	RL	S	T	U	VA	VB	WA			WB			X	XA	XB	XC	XL	YY	YL	Z
							25 st	50, 75, 100 st	Over 100 st	25 st	50, 75, 100 st	Over 100 st								
50	14	50	156	116	140	100	24	48	124	36	48	86	68	5	6	4	8	M12 x 1.75	24	24
80	20	65	228	170	214	138	28	52	128	42	54	92	100	6	7	5	10	M14 x 2.0	28	28

- D-□
- X□
- Individual -X□

Compact Guide Cylinder/ High Precision Ball Bushing Bearing Type

Series *MGPA*

Basic Type (Rubber Bumper): $\varnothing 12$, $\varnothing 16$, $\varnothing 20$, $\varnothing 25$, $\varnothing 32$, $\varnothing 40$, $\varnothing 50$, $\varnothing 63$, $\varnothing 80$, $\varnothing 100$

With Air Cushion: $\varnothing 16$, $\varnothing 20$, $\varnothing 25$, $\varnothing 32$, $\varnothing 40$, $\varnothing 50$, $\varnothing 63$, $\varnothing 80$, $\varnothing 100$

With End Lock: $\varnothing 20$, $\varnothing 25$, $\varnothing 32$, $\varnothing 40$, $\varnothing 50$, $\varnothing 63$, $\varnothing 80$, $\varnothing 100$



MGJ

MGP

MGQ

MGG

MGC

MGF

MGZ

MGT

D-□

-X□

Individual
-X□

Compact Guide Cylinder/High Precision Ball Bushing Bearing Type Series **MGPA**

Basic Type (Rubber Bumper): $\varnothing 12, \varnothing 16, \varnothing 20, \varnothing 25, \varnothing 32, \varnothing 40, \varnothing 50, \varnothing 63, \varnothing 80, \varnothing 100$
 With Air Cushion: $\varnothing 16, \varnothing 20, \varnothing 25, \varnothing 32, \varnothing 40, \varnothing 50, \varnothing 63, \varnothing 80, \varnothing 100$
 With End Lock: $\varnothing 20, \varnothing 25, \varnothing 32, \varnothing 40, \varnothing 50, \varnothing 63, \varnothing 80, \varnothing 100$

How to Order

**Basic type (Rubber bumper)
With air cushion**

MGPA 50 [] - **50** [] - **M9BW** [] - []

Compact Guide Cylinder
 High precision ball bushing bearing type
 Bore size
 Thread type
 Cylinder stroke
 Auto switch
 Cushion type
 Made to Order Specification
 Number of auto switches

Bore size	12	16	20	25	32	40	50	63	80	100
12 mm	12	16	20	25	32	40	50	63	80	100
16 mm		16	20	25	32	40	50	63	80	100
20 mm			20	25	32	40	50	63	80	100
25 mm				25	32	40	50	63	80	100
32 mm					32	40	50	63	80	100

Auto switch	Nil	Without auto switch (Built-in magnet)
Number of auto switches	Nil	2 pcs.
	S	1 pc.
	n	n pcs.

Cushion type	Nil	Rubber bumper
	A	Air cushion

Refer to "Standard Stroke" on page 331.
 * Air cushions are not available for $\varnothing 12$.

With end lock

MGPA 50 [] - **50** - **H N** - **M9BW** [] - []

Compact Guide Cylinder
 High precision ball bushing bearing type
 Bore size
 Thread type
 Cylinder stroke
 Auto switch
 Manual release type
 Lock position
 Made to Order Specification
 Number of auto switches

Bore size	20	25	32	40	50	63	80	100
20 mm	20	25	32	40	50	63	80	100
25 mm		25	32	40	50	63	80	100
32 mm			32	40	50	63	80	100
40 mm				40	50	63	80	100

Thread type	Nil	Rc
	N	NPT
	TF	G

Auto switch	Nil	Without auto switch (Built-in magnet)
Manual release type	N	Non-lock type
	L	Lock type

Lock position	H	Head end lock
	R	Rod end lock

Refer to "Standard Stroke" on page 331.

Applicable Auto Switch/Refer to pages 1719 to 1827 for further information on auto switches.

Type	Special function	Electrical entry	Indicator light	Wiring (Output)	Load voltage		Auto switch model		Lead wire length (m)				Pre-wired connector	Applicable load	
					DC	AC	Perpendicular	In-line	0.5 (Nil)	1 (M)	3 (L)	5 (Z)			
Solid state switch	—	Grommet	Yes	3-wire (NPN)	5V, 12V	—	M9NV	M9N	●	●	●	○	○	IC circuit	Relay, PLC
				3-wire (PNP)					●	●	●	○			
				2-wire	12V				●	●	●	○			
				3-wire (NPN)	5V, 12V				●	●	●	○			
	3-wire (PNP)			●					●	●	○				
	Diagnostic indication (2-color indication)			2-wire	12V				●	●	●	○			
				3-wire (NPN)	5V, 12V				○	○	●	○			
	Water resistant (2-color indication)			3-wire (PNP)					12V	○	○	●			
				2-wire	—					—	—	●			
	Magnetic field resistant (2-color indication)			3-wire (NPN)	—				No	3-wire (NPN equivalent)	5V	—			
3-wire (PNP)		100V	●	—		●	—								
2-wire			100V or less	●		—	●	—							
2-wire (Non-polar)		—		—		—	●	●		—	—		—	—	—

* Lead wire length symbols: 0.5 m..... Nil (Example) M9NV
 1 m..... M (Example) M9NVM
 3 m..... L (Example) M9NWL
 5 m..... Z (Example) M9NZZ

* Solid state auto switches marked with "○" are produced upon receipt of order.
 * D-P4DW type can be mounted on bore sizes 32 to 100.

* Since there are other applicable auto switches than listed, refer to page 336 for details.
 * For details about auto switches with pre-wired connector, refer to pages 1784 and 1785.
 * Auto switches are shipped together (not assembled).

Compact Guide Cylinder High Precision Bushing Bearing Type *Series MGPA*

Specifications



Non-rotating accuracy of plate: $\pm 0.01^\circ$

Plate displacement amount : 0.05 mm

(MGPA $\phi 12$ -10 st, when
Load mass is 1.7 kg.)



Made to Order Specifications
(For details, refer to pages 1829 to 2021.)

Symbol	Specifications
—XA□	Change of rod end shape
—XC4	With heavy duty scraper
—XC8	Adjustable stroke cylinder/Adjustable extension type
—XC9	Adjustable stroke cylinder/Adjustable retraction type
—XC19	With air cushion, Intermediate stroke (Spacer type)
—XC35	With coil scraper
—XC69	With shock absorber
—XC79	Machining tapped hole, drilled hole and pin hole additionally.
—XC82	Bottom mounting style
—X144	Symmetrical port position
—X867	Lateral piping type (Change of plug position)

Refer to pages 334 to 336 for cylinders with auto switches.

- Minimum auto switch mounting stroke
- Proper auto switch mounting position (detection at stroke end) and mounting height
- Operating range
- Switch mounting bracket: Part no.



Dimensions for all models are the same as the ball bushing bearing type. Refer to the following pages.

- Basic Type (Rubber Bumper) → P.286 to 288
- With Air Cushion → P.304 to 306
- With End Lock → P.314 to 316

Action	Double acting	
Fluid	Air	
Proof pressure	1.5 MPa	
Max. operating pressure	1.0 MPa	
Ambient and fluid temperature	-10 to 60°C (No freezing)	
Piston speed	$\phi 12$ to $\phi 63$	50 to 500 mm/s
	$\phi 80$, $\phi 100$	50 to 400 mm/s
Lubrication	Non-lube	
Stroke length tolerance	$^{+1.5}_0$ mm	

Minimum Operating Pressure

Basic Type (Rubber Bumper)

Bore size (mm)	Min. operating pressure
$\phi 12$, $\phi 16$	0.12 MPa
$\phi 20$ to $\phi 100$	0.1 MPa

With Air Cushion

Bore size (mm)	Min. operating pressure
$\phi 16$	0.15 MPa
$\phi 20$ to $\phi 100$	0.12 MPa

With End Lock

Bore size (mm)	Min. operating pressure
$\phi 20$ to $\phi 100$	0.15 MPa

Standard Stroke

Basic Type (Rubber Bumper)

Bore size (mm)	Standard stroke (mm)
12, 16	10, 20, 30, 40, 50, 75, 100, 125, 150, 175, 200, 250
20, 25	20, 30, 40, 50, 75, 100, 125, 150, 175, 200, 250, 300, 350, 400
32, 40, 50, 63, 80, 100	25, 50, 75, 100, 125, 150, 175, 200, 250, 300, 350, 400

With Air Cushion

Bore size (mm)	Standard stroke (mm)
16	25, 50, 75, 100, 125, 150, 175, 200, 250
20, 25, 32, 40, 50, 63	25, 50, 75, 100, 125, 150, 175, 200, 250, 300, 350, 400
80, 100	50, 75, 100, 125, 150, 175, 200, 250, 300, 350, 400

With End Lock

Bore size (mm)	Standard stroke (mm)
20, 25, 32, 40, 50, 63, 80, 100	25, 50, 75, 100, 125, 150, 175, 200, 250, 300, 350, 400

Manufacture of Intermediate Stroke

Basic Type (Rubber Bumper)

Description	Spacer installation type Spacers are installed in the standard stroke cylinder.	
Part no.	Refer to "How to Order" for the standard specification.	
Applicable stroke	$\phi 12$, $\phi 16$	1 to 249
	$\phi 20$ to $\phi 32$	1 to 399
	$\phi 40$ to $\phi 100$	5 to 395
Example	Part no.: MGPA20-39 A spacer 1 mm in width is installed in a MGPA20-40. C dimension is 77 mm.	

With Air Cushion

Description	1 mm interval are available by replacing collars of a standard stroke cylinder.	
	Minimum manufacturable stroke $\phi 16$ to $\phi 63$: 15mm $\phi 80$, $\phi 100$: 20mm Select a rubber bumper type, because the cushion effect is not obtainable for less than this stroke.	
Part no.	Suffix "-XC19" to the end of standard part number.	
Applicable stroke	$\phi 16$	15 to 249
	$\phi 20$ to $\phi 63$	15 to 399
	$\phi 80$, $\phi 100$	20 to 399
Example	Part no.: MGPA20-35A-XC19 A 15 mm width collar is installed in MGPA20-50A. C dimension is 112 mm.	

With End Lock

Description	Spacer installation type 5 mm interval are available by installing a spacer on a standard stroke cylinder.	
Part no.	Refer to "How to Order" for the standard specification.	
Applicable stroke	5 to 395	
Example	Part no.: MGPA20-35-HN A spacer 15 mm in width is installed in a MGPA20-50-HN. C dimension is 112 mm.	

MGJ

MGP

MGQ

MGG

MGC

MGF

MGZ

MGT

D-□

-X□

Individual
-X□

Series MGPA

Non-rotating Accuracy of Plate

For non-rotating accuracy θ without load, use a value no more than the values in the table as a guide.

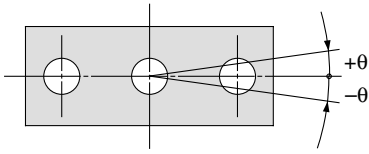

Bore size (mm)	Non-rotating accuracy θ
12	$\pm 0.01^\circ$
16	
20	
25	
32	
40	
50	
63	
80	
100	

⚠ Caution

Positioning accuracy for pin hole on the plate

Dispersion of dimensions when machining each component will be accumulated in the plate pin hole positioning accuracy when mounting this cylinder. Below values are referred as a guide.

[Side mounting]

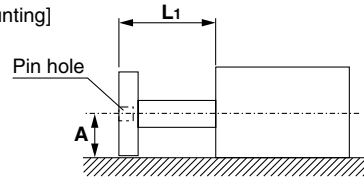

$$A = \text{Catalog dimension} \pm (0.1 + L1 \times 0.0008) \text{ [mm]}$$

* : To be 0.15 for $\phi 80, 100$.

Note) Displacement by load and self-weight deflection by plate and guide rod are not included.

[Bottom mounting]

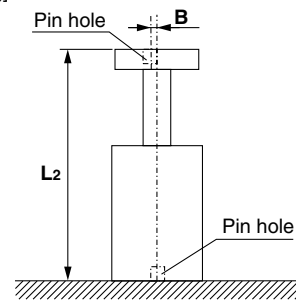

$$B = \pm (0.045 + L2 \times 0.0016) \text{ [mm]}$$

Plate Displacement Amount (Reference Values)

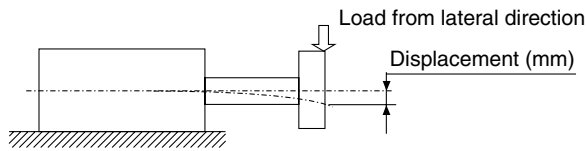

MGPA12

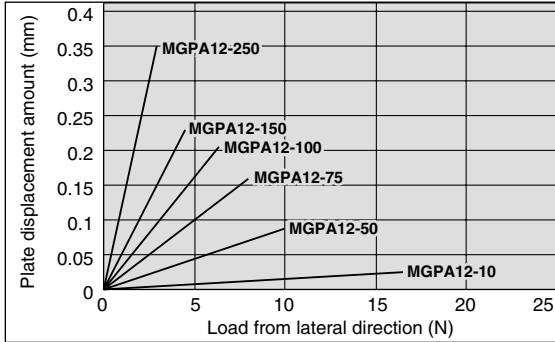

MGPA32/40

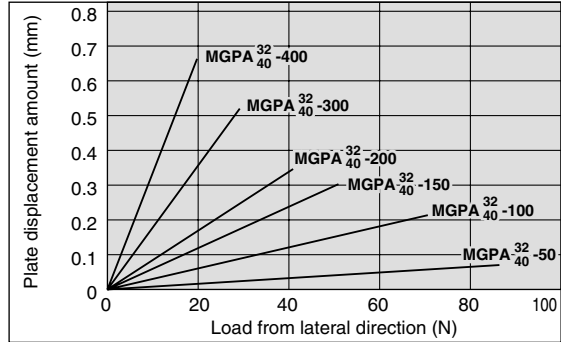

MGPA16

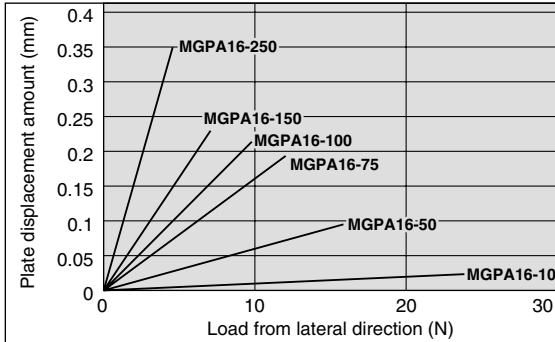

MGPA50/63

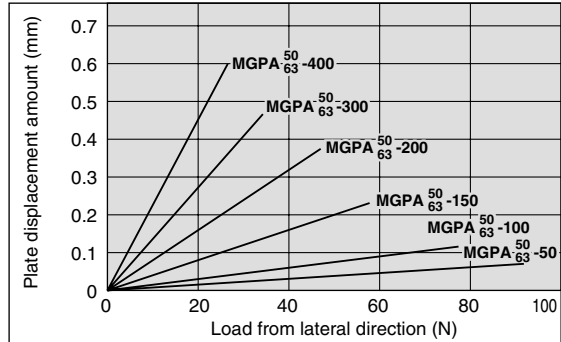

MGPA20

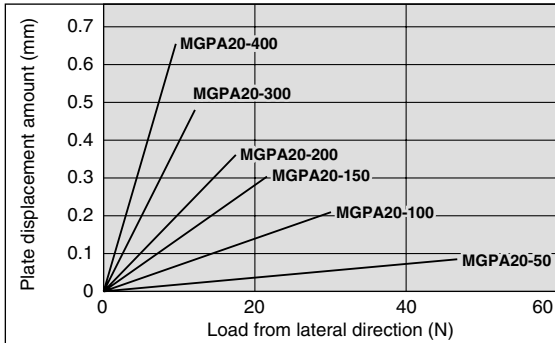

MGPA80

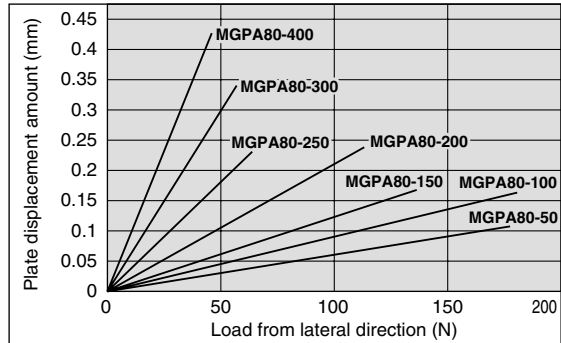

MGPA25

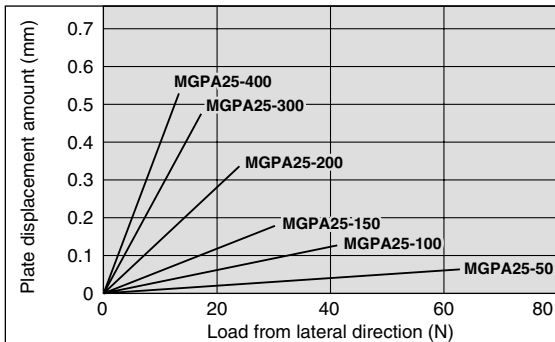

MGPA100

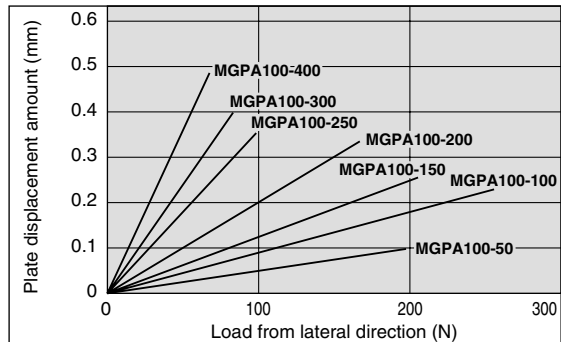

Note 1) The guide rod and self-weight for the plate are not included in the above displacement values.

Note 2) Regarding the allowable rotational torque and the operating range as a lifter, refer to pages 272 to 288 in the standard type of Series MGPL, since it is identical.

MGJ

MGP

MGQ

MGG

MGC

MGF

MGZ

MGT

D-□

-X□

Individual
-X□

Series MGP

Auto Switch Proper Mounting Position (Detection at Stroke End) and Its Mounting Height

- For D-A9□
- For D-A9□V
- For D-M9□
- For D-M9□V
- For D-M9□W
- For D-M9□WV
- For D-M9□AL
- For D-M9□AVL
- For D-Z7□
- For D-Z80
- For D-Y59□
- For D-Y69□
- For D-Y7P
- For D-Y7PV
- For D-Y7□W
- For D-Y7□WV
- For D-Y7BA

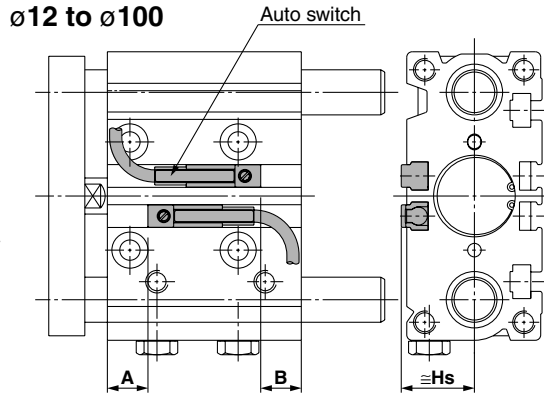

For D-P4DW (* Cannot be mounted on bore sizes $\phi 25$ or less.)
 $\phi 32$ to $\phi 63$

$\phi 80, \phi 100$

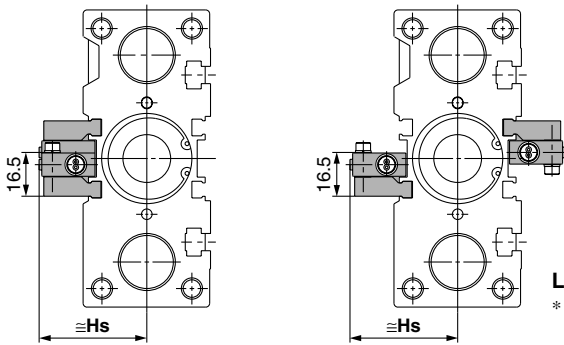

Less than 25 to 75 strokes
 * For bore sizes $\phi 40$ through $\phi 63$
 with two switches, one switch is
 mounted on each side.

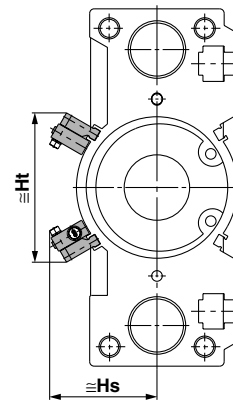

Auto Switch Proper Mounting Position

Applicable cylinder series: MGP, MGPS (Heavy duty guide rod type)
 MGPA (High precision ball bushing/Basic type) (mm)

Auto switch model	D-M9□ D-M9□V D-M9□W D-M9□WV D-M9□AL D-M9□AVL		D-A9□ D-A9□V		D-Z7□/Z80 D-Y59□/Y7P D-Y69□/Y7PV D-Y7□W D-Y7□WV D-Y7BAL		D-P4DWL	
	A	B	A	B	A	B	A	B
12	6	8	2	4	1	3	—	—
16	9	9	5	5	4	4	—	—
20	9.5	12.5	5.5	8.5	4.5	7.5	—	—
25	9.5	13	5.5	9	4.5	8	—	—
32	10.5	12	6.5	8	5.5	7	5	6.5
40	14.5	14.5	10.5	10.5	9.5	9.5	9	9
50	12.5	16.5	8.5	12.5	7.5	11.5	7	11
63	15	19	11	15	10	14	9.5	13.5
80	18	23.5	14	19.5	13	18.5	12.5	18
100	22.5	28.5	18.5	24.5	17.5	23.5	17	23

Note) Adjust the auto switch after confirming the operating conditions in the actual setting.

Auto Switch Proper Mounting Position

Applicable cylinder series: MGP (Air cushion)
 MGPA (High precision ball bushing/Air cushion) (mm)

Auto switch model	D-M9□ D-M9□V D-M9□W D-M9□WV D-M9□AL D-M9□AVL		D-A9□ D-A9□V		D-Z7□/Z80 D-Y59□/Y7P D-Y69□/Y7PV D-Y7□W D-Y7□WV D-Y7BAL		D-P4DWL	
	A	B	A	B	A	B	A	B
16	22.5	20.5	18.5	16.5	17.5	15.5	—	—
20	31	16	27	12	26	11	—	—
25	27.5	20	23.5	16	22.5	15	—	—
32	21	26.5	17	22.5	16	21.5	15.5	21
40	31	23	27	19	26	18	25.5	17.5
50	32	22	28	18	27	17	26.5	16.5
63	33	26	29	22	28	21	27.5	20.5
80	30	36.5	26	32.5	25	31.5	24.5	31
100	33.5	42.5	29.5	38.5	28.5	37.5	28	37

Note) Adjust the auto switch after confirming the operating conditions in the actual setting.

Auto Switch Mounting Height

Auto switch model	D-A9□/M9□/M9□W/M9□AL D-Z7□/Z80/Y59□/Y7P D-Y7□W/Y7BAL		D-A9□V		D-M9□V D-M9□WV D-M9□AVL		D-Y69□ D-Y7PV D-Y7□WV		D-P4DWL	
	Hs	Ht	Hs	Ht	Hs	Ht	Hs	Ht	Hs	Ht
12	13.5	—	17	—	19.5	—	15	—	—	—
16	16	—	19.5	—	22	—	17.5	—	—	—
20	18.5	—	22	—	24.5	—	20	—	—	—
25	20.5	—	24	—	26	—	21.5	—	—	—
32	23	—	26.5	—	29	—	24.5	—	41.5	—
40	27	—	30.5	—	33	—	28.5	—	44.5	—
50	32.5	—	36	—	38.5	—	34	—	50	—
63	39.5	—	43	—	45.5	—	41	—	57	—
80	40	—	43	71.5	45	74	41	70	61	84.5
100	50	—	53	83	55	85.5	51	81.5	71	96.5

Auto Switch Proper Mounting Position (Detection at Stroke End) and Its Mounting Height

With rod end lock

- For D-A9□ For D-Z7□
- For D-A9□V For D-Z80
- For D-M9□ For D-Y59□
- For D-M9□V For D-Y69□
- For D-M9□W For D-Y7P
- For D-M9□WV For D-Y7PV
- For D-M9□A For D-Y7□W
- For D-M9□AVL For D-Y7□WV
- For D-M9□AVL For D-Y7BA

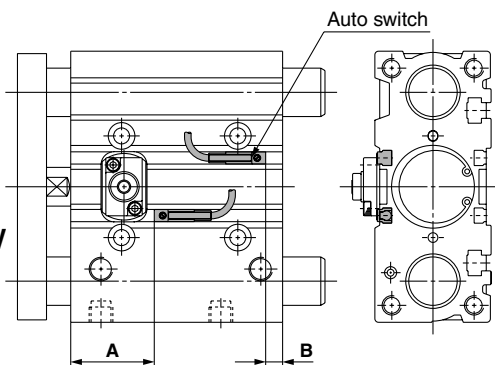

For D-P4DW (* Cannot be mounted on bore sizes ø25 or less.)
ø32 to ø63

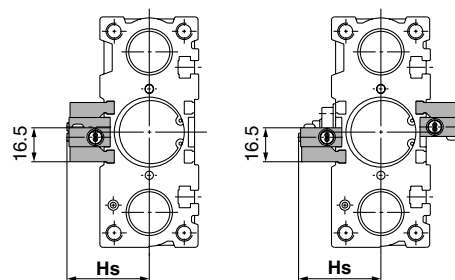

For 25 stroke
* For bore sizes ø40 to 63 with two switches, one switch is mounted on each side.

Auto Switch Proper Mounting Position (mm)

Auto switch model	D-M9□ D-M9□V D-M9□W D-M9□WV D-M9□AL D-M9□AVL		D-A9□ D-A9□V		D-Z7□/Z80 D-Y59□/Y7P D-Y69□/Y7PV D-Y7□W D-Y7□WV D-Y7BAL		D-P4DWL	
	A	B	A	B	A	B	A	B
Bore size (mm)								
20	40	7	36	3	35	2	—	—
25	40.5	7	36.5	3	35.5	2	—	—
32	37.5	10	33.5	6	32.5	5	32	4.5
40	43.5	10.5	39.5	6.5	38.5	5.5	38	5
50	44.5	9.5	40.5	5.5	39.5	4.5	39	4
63	47	12	43	8	42	7	41.5	6.5
80	68	23.5	64	19.5	63	18.5	62.5	18
100	72.5	28.5	68.5	24.5	67.5	23.5	67	23

Note) Adjust the auto switch after confirming the operating conditions in the actual setting.

With head end lock

- For D-A9□ For D-Z7□
- For D-A9□V For D-Z80
- For D-M9□ For D-Y59□
- For D-M9□V For D-Y69□
- For D-M9□W For D-Y7P
- For D-M9□WV For D-Y7PV
- For D-M9□AL For D-Y7□W
- For D-M9□AVL For D-Y7□WV
- For D-M9□AVL For D-Y7BA

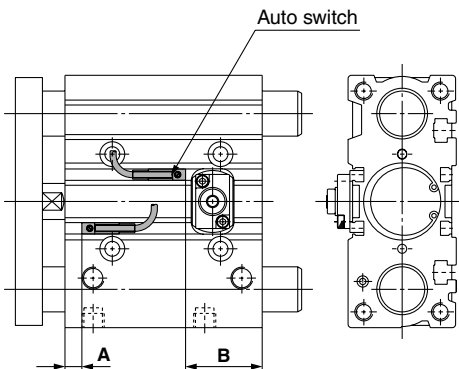

Auto Switch Proper Mounting Position (mm)

Auto switch model	D-M9□ D-M9□V D-M9□W D-M9□WV D-M9□AL D-M9□AVL		D-A9□ D-A9□V		D-Z7□/Z80 D-Y59□/Y7P D-Y69□/Y7PV D-Y7□W D-Y7□WV D-Y7BAL		D-P4DWL	
	A	B	A	B	A	B	A	B
Bore size (mm)								
20	9	38	5	34	4	33	—	—
25	9.5	38	5.5	34	4.5	33	—	—
32	10.5	37	6.5	33	5.5	32	5	31.5
40	14.5	39.5	10.5	35.5	9.5	34.5	9	34
50	12.5	41.5	8.5	37.5	7.5	36.5	7	36
63	15	44	11	40	10	39	9.5	38.5
80	18	73.5	14	69.5	13	68.5	12.5	68
100	22.5	78.5	18.5	74.5	17.5	73.5	17	73

Note) Adjust the auto switch after confirming the operating conditions in the actual setting.

ø80/ø100

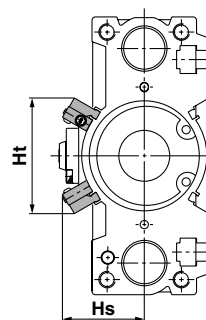

Auto Switch Mounting Height (mm)

Bore size (mm)	Hs	Ht
32	41.5	—
40	44.5	—
50	50	—
63	57	—
80	61	84.5
100	71	96.5

Mounting of Auto Switch

Caution

In the case of 25 st or less with head side end lock type, it might not insert auto switch from the rod side. In this case, install it after removing the plate temporarily. Regarding the plate removal and the way of assembly, please consult with SMC.

- MGJ
- MGP
- MGQ
- MGG
- MGC
- MGF
- MGZ
- MGT

- D-□
- X□
- Individual -X□

Minimum Auto Switch Mounting Stroke

		(mm)									
Auto switch model	No. of auto switches mounted	ø12	ø16	ø20	ø25	ø32	ø40	ø50	ø63	ø80	ø100
D-A9□	1 pc.	10					5				
	2 pcs.	15					10				
D-A9□V D-M9□V	1 pc.				5						
	2 pcs.				10						
D-M9□	1 pc.	15	10					5			
	2 pcs.	15			10						
D-M9□W	1 pc.	15				10					
	2 pcs.	15				10					
D-M9□WV D-M9□AVL	1 pc.				10						
	2 pcs.				10						
D-M9□AL	1 pc.	15					10				
	2 pcs.			15							
D-Z7□ D-Z80	1 pc.	10						5			
	2 pcs.	15						10			
D-Y59□ D-Y7P	1 pc.	10						5			
	2 pcs.	15						10			
D-Y69□ D-Y7PV	1 pc.				5						
	2 pcs.				5						
D-Y7□W D-Y7□WV	1 pc.				10						
	2 pcs.				15						
D-Y7BAL	1 pc.	15					10				
	2 pcs.			15							
D-P4DWL	1 pc.							10			
	2 pcs., different side							20			
	2 pcs., same side							75			

- * D-P4DW can be mounted on bore size ø32 to ø100.
- * The air cushion type is available in ø16 to ø100.
- * The heavy duty guide rod type is available in ø50 and ø80.

Operating Range

Auto switch model	Bore size (mm)									
	12	16	20	25	32	40	50	63	80	100
D-A9□/A9□V	7	9.5	9	9	9	9.5	9.5	11	10.5	10.5
D-M9□/M9□V D-M9□W/M9□WV D-M9□AL/M9□AVL	4	5	5.5	5	6	5.5	6	6.5	6	7
D-Z7□/Z80	7.5	10	10	10	10.5	10.5	10.5	11.5	11.5	12
D-Y59□/Y69□ D-Y7P/Y7PV D-Y7□W/Y7□WV D-Y7BAL	5.5	7.5	7.5	7	6.5	6	7	8	9.5	10
D-P4DWL	—	—	—	—	5	4	4	5	4	4

- * Since the operating range is provided as a guideline including hysteresis, it cannot be guaranteed (assuming approximately ±30% dispersion). It may vary substantially depending on an ambient environment.
- * The air cushion type is available in ø16 to ø100.
- * Cylinders with an end lock are available in ø20 to ø100.
- * The heavy duty guide rod type is available in ø50 and ø80.

Auto Switch Mounting Bracket: Part No.

Auto switch model	Bore size (mm)	
	ø12 to ø25	ø32 to ø100
D-A9□/A9□V D-M9□/M9□V D-M9□W/M9□WV D-M9□AL/M9□AVL	BMG2-012	
D-P4DWL	—	BMG1-040

- * The air cushion type is available in ø16 to ø100.
- * Cylinders with an end lock are available in ø20 to ø100.
- * The heavy duty guide rod type is available in ø50 and ø80.

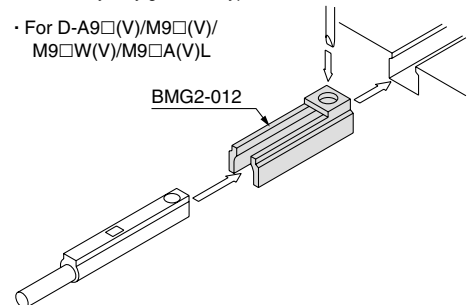

Besides the models listed in How to Order, the following auto switches are applicable. For detailed specifications, refer to pages 1719 to 1827.

Auto switch type	Model	Electrical entry (Fetching direction)	Features
Reed	D-Z73, Z76	Grommet (In-line)	—
	D-Z80		Without indicator light
Solid state	D-Y69A, Y69B, Y7PV	Grommet (Perpendicular)	—
	D-Y7NWV, Y7PWV, Y7BWV		Diagnostic indication (2-color indication)
	D-Y59A, Y59B, Y7P		—
	D-Y7NW, Y7PW, Y7BW	Grommet (In-line)	Diagnostic indication (2-color indication)
	D-Y7BAL		Water resistant (2-color indication)
	D-P5DWL		Magnetic field resistant (2-color indication)

- * For solid state auto switches, auto switches with a pre-wired connector are also available. Refer to pages 1784 and 1785 for details.
- * Normally closed (NC = b contact), solid state auto switch (D-F9G/F9H/Y7G/Y7H type) are also available. For details, refer to pages 1746 and 1748.

Compact Guide Cylinder with Lock

Series *MLGP*

ø20, ø25, ø32, ø40, ø50, ø63, ø80, ø100



CLJ2

CLM2

CLG1

CL1

MLGC

CNG

MNB

CNA

CNS

CLS

CLQ

RLQ

MLU

MLGP

ML1C

Drop prevention when the pressure of air source is decreased or the residual pressure is released.

Drop prevention for press fitting jig

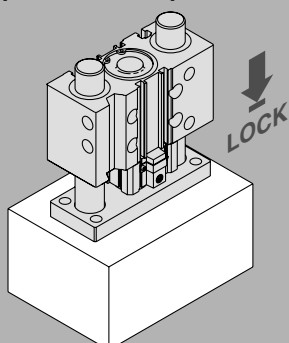

Drop prevention for lifter

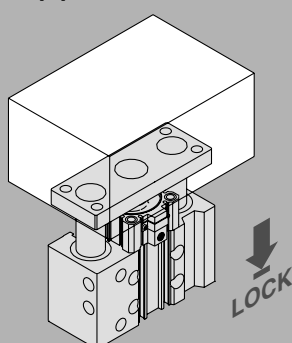

Holding a clamped condition

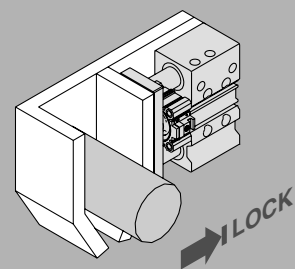

D-□

-X□

Individual

-X□

Drop prevention is possible



- Drop prevention for mid-stroke emergency stops
- Locking position can be changed in accordance with the external stopper position and thickness of clamped workpieces.



Drop prevention for press fitting jig

Drop prevention for lifter

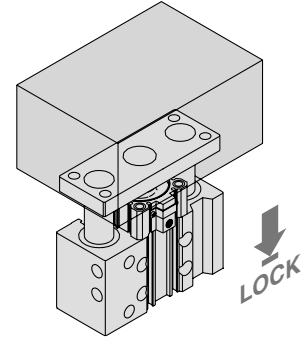
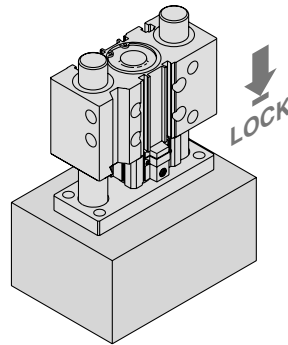

Holding a clamped condition

Compact Guide Cylinder with Lock

Series MLGP

∅20,∅25,∅32,∅40,∅50,∅63,∅80,∅100

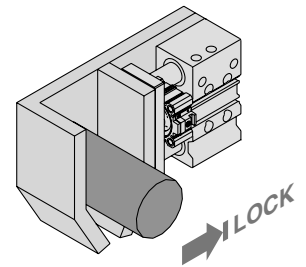

Simple construction

Simple and reliable locking type

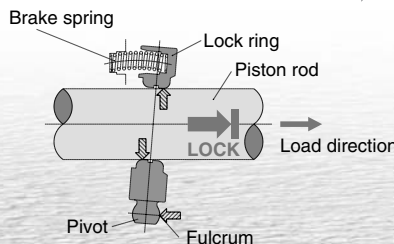
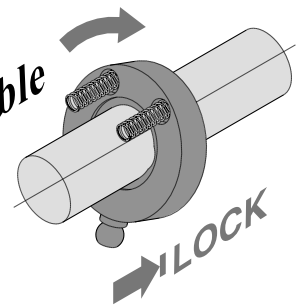

Unlocking port: Air exhausted

1. The lock ring is tilted by the spring force.
2. The tilting is increased by the load and the piston rod is securely locked.

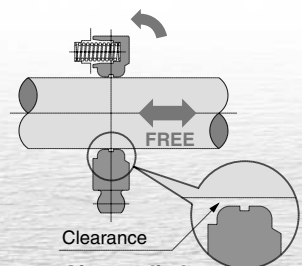

Unlocking port: Air supplied

1. The lock ring becomes perpendicular to the piston rod, creating clearance between the piston rod and lock ring, which allows the piston rod to move freely.

within the entire stroke at any position

Low profile with compact lock unit

Lock unit length: A/26.5 mm to 51.5 mm

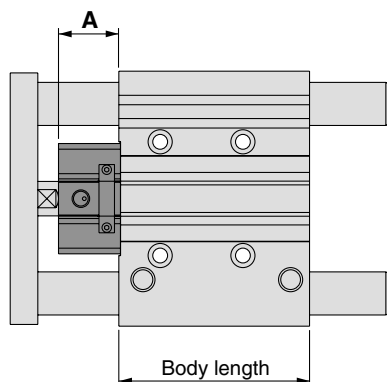

Bore size (mm)	A (mm)
20	26.5
25	30.5
32	31.5
40	34
50	35
63	38
80	43
100	51.5

Body length is the same as the standard MGP

Easy manual unlocking

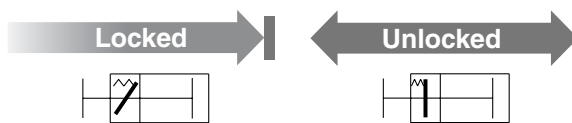

Ø40 to Ø100

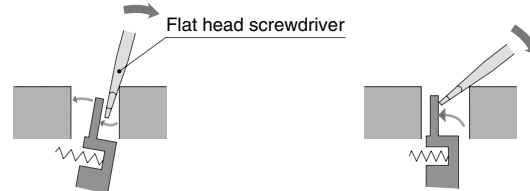

Ø20 to Ø32

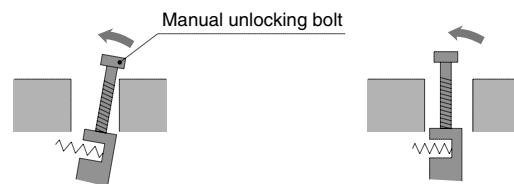

CLJ2

CLM2

CLG1

CL1

MLGC

CNG

MNB

CNA

CNS

CLS

CLQ

RLQ

MLU

MLGP

ML1C

Locking direction is selectable

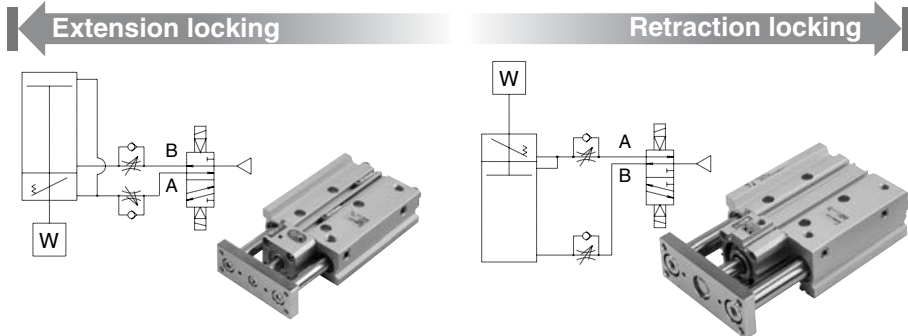

Two types of guide rod bearing for different applications

Slide bearing

Ball bushing bearing

Excellent wear resistance allows use with high loads.

Provides high precision and smooth operation.

Four types of mounting

- Easy positioning
- Knock pin holes provided on each mounting surface.

Top mounting | Side mounting

T-slot side mounting

Bottom mounting

Wide Variations from Ø20 to Ø100

Series	Bearing	Locking direction	Bore size (mm)	Standard stroke (mm)													
				20	25	30	40	50	75	100	125	150	175	200	250	300	350
MLGP	Slide bearing	Extension Locking	20	●		●	●	●	●	●	●	●	●	●	●	●	●
			25	●		●	●	●	●	●	●	●	●	●	●	●	●
			32		●			●	●	●	●	●	●	●	●	●	●
	Ball bushing bearing	Retraction Locking	40		●			●	●	●	●	●	●	●	●	●	●
			50		●			●	●	●	●	●	●	●	●	●	●
			63		●			●	●	●	●	●	●	●	●	●	●
			80		●			●	●	●	●	●	●	●	●	●	
			100					●	●	●	●	●	●	●	●	●	



D-□

-X□

Individual -X□



Series MLGP

Specific Product Precautions 1

Be sure to read before handling. Refer to front matters 42 and 43 for Safety Instructions and pages 3 to 11 for Actuator and Auto Switch Precautions.

Selection

Warning

- 1. The holding force (max. static load) indicates the maximum capability to hold a static load without vibration and impact. Therefore, the maximum load (workpiece mass) should not exceed 50% of the holding force (max. static load). Select the load mass when unlocked in accordance with 6 below.**
- 2. Do not use for intermediate stops while the cylinder is operating.**

This cylinder is designed for locking against inadvertent movement from a stationary condition. Do not perform intermediate stops while the cylinder is operating, as this may cause unlocking malfunction, damage or shorten the service life.
- 3. Select the correct locking direction, as this cylinder does not generate holding force opposite to the locking direction.**

The extension locking does not generate holding force in the cylinder's retracting direction, and the retraction locking does not generate holding force in the cylinder's extension direction.
- 4. Even when locked, there may be stroke movement up to 1 mm in the locking direction due to external forces such as the workpiece weight.**

Even when locked, if air pressure drops, stroke movement up to 1 mm may be generated in the locking direction of the lock mechanism due to external forces such as the workpiece weight.
- 5. When in the locked state, do not apply a load accompanied by an impact shock, strong vibration or turning force, etc.**

This may damage the locking mechanism, shorten the service life or cause unlocking malfunction.
- 6. Operate so that load mass, cylinder speed and eccentric distance are within the limiting ranges in the specifications and model selection graphs.**

If the products are used beyond the limiting range, it may lead to a reduced service life or cause damage to the machinery. (Refer to pages 900 and 901 for specifications and pages 887 to 898 for the Model Selection.)

Pneumatic Circuit

Warning

- **Drop prevention circuit**
- 1. Do not use 3 position valves with circuit example 1.**

The lock may be released due to inflow of the unlocking pressure.
 - 2. Install speed controllers for meter-out control. (Circuit example 1)**

When they are not installed or they are used under meter-in control, it may cause malfunction.
 - 3. Branch off the compressed air piping for the lock unit between the cylinder and the speed controller. (Circuit example 1)**

Note that branching off in another section can cause a reduction in service life.
 - 4. Perform piping so that the side going from the piping junction to the lock unit is short. (Circuit example 1)**

If the lock release port side is longer than another side from the piping junction, this may cause unlocking malfunction or shorten the service life.
 - 5. Be aware of reverse exhaust pressure flow from common exhaust type valve manifolds. (Circuit example 1)**

Since the lock may be released due to reverse exhaust pressure flow, use an individual exhaust type manifold or single type valve.
 - 6. Be sure to release the lock before operating the cylinder. (Circuit example 2)**

When the lock release delays, a cylinder may eject at high speed, which is extremely dangerous. It may also damage the cylinder, greatly shorten the service life or cause locking malfunction. Even when a cylinder moves freely, be sure to release the lock and operate the cylinder.
 - 7. Be aware that the locking action may be delayed due to the piping length or the timing of exhaust. (Circuit example 2)**

The locking action may be delayed due to the piping length or the timing of exhaust, which also makes the stroke movement toward the lock larger. Install the solenoid valve for locking closer to the cylinder than the cylinder drive solenoid valve.

Emergency stop circuit

- 1. Perform emergency stops with the pneumatic circuit. (Circuit examples 3 and 4)**

This cylinder is designed for locking against inadvertent movement from a stationary condition. Do not perform intermediate stops while the cylinder is operating, as this may cause unlocking malfunction or shorten the service life. Emergency stops must be performed with the pneumatic circuit, and workpieces must be held with the locking mechanism after the cylinder fully stops.
- 2. When restarting the cylinder from the locked state, remove the workpiece and exhaust the residual pressure in the cylinder. (Circuit examples 3 and 4)**

A cylinder may eject at high speed, which is extremely dangerous. It may also damage the cylinder, greatly shorten the service life or cause locking malfunction.
- 3. Be sure to release the lock before operating the cylinder. (Circuit example 4)**

When the lock release delays, the cylinder may eject at high speed, which is extremely dangerous. It may also damage the cylinder, greatly shorten the service life or cause locking malfunction. Even when the cylinder moves freely, be sure to release the lock and operate the cylinder.



Series MLGP Specific Product Precautions 2

Be sure to read before handling. Refer to front matters 42 and 43 for Safety Instructions and pages 3 to 11 for Actuator and Auto Switch Precautions.

Pneumatic Circuit

Warning

Circuit examples

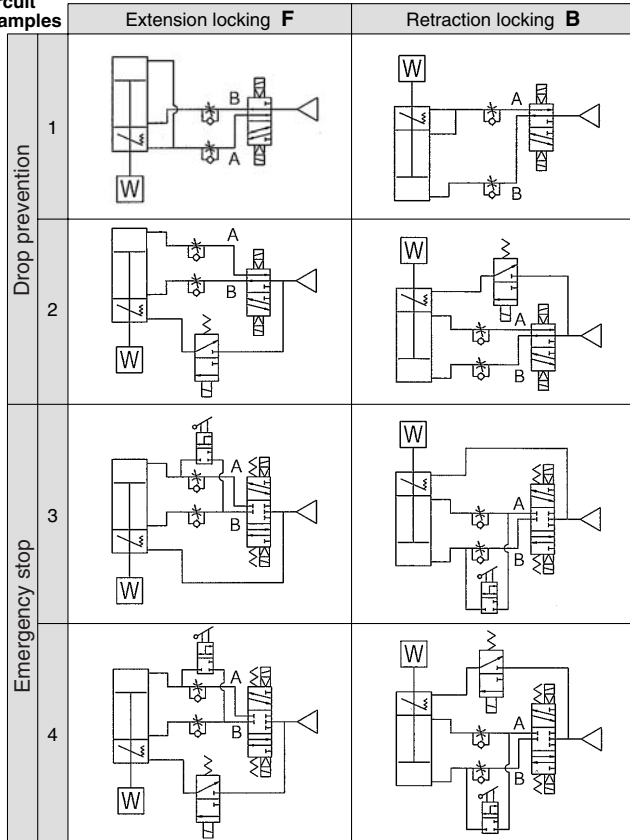

Stopper Circuit

- When used as a stopper, be careful that the workpiece does not collide with the cylinder in a locked condition. Use the guide cylinder with the circuit below.

If the workpiece were bumped into the cylinder in the locked state, it could be unlocked by shock or the locking mechanism and the piston rod could be damaged, that could shorten its service life substantially or result in breakage.

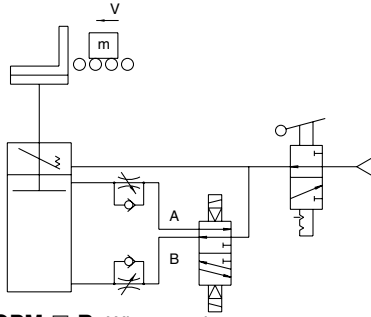

MLGPM-□-B: When used as stopper

Mounting

Warning

- Take precautions to prevent your fingers or hands from getting caught between the plate and the cylinder body or the lock body.

Be very careful to prevent your hands or fingers from getting caught in the gap between the cylinder body and the lock body when air is applied.

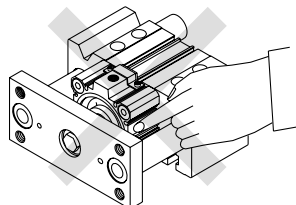

Mounting

Caution

- Be sure to connect the load to the plate section with the lock in an unlocked condition. If this is done in the locked state, it may cause damage to the lock mechanism. Sizes $\phi 20$ through $\phi 32$ have a built-in holding function for the unlocked state, allowing the unlocked condition to be maintained even without an air supply. For $\phi 40$ through $\phi 100$, simply connect piping to the unlocking port and supply air pressure of 0.2 MPa or more.
- When performing mounting adjustment, supply air pressure only to the unlocking port.
- Cylinder bottom**
Since the guide rods project from the bottom of the cylinder at the end of the retraction stroke, provide bypass ports in the mounting surface, as well as holes for the hexagon socket head mounting screws, when the cylinder is mounted from the bottom. Furthermore, when subjected to impact in use as a stopper, etc., screw the mounting bolts in to a depth of 2d or more.

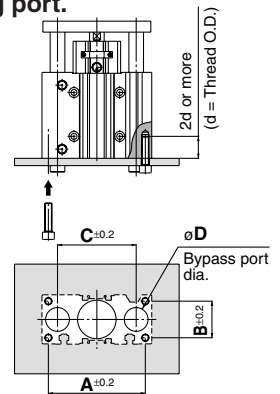

Bore size (mm)	A (mm)	B (mm)	C (mm)	D		Hexagon socket head cap screw
				MLGPM	MLGPL	
20	72	24	54	14	12	M5 x 0.8
25	82	30	64	18	15	M6 x 1.0
32	98	34	78	22	18	M8 x 1.25
40	106	40	86	22	18	M8 x 1.25
50	130	46	110	27	22	M10 x 1.5
63	142	58	124	27	22	M10 x 1.5
80	180	54	156	33	28	M12 x 1.75
100	210	62	188	39	33	M14 x 2.0

Piping

Caution

Depending on the operating condition, change the position of plugs for the piping port.

- For M5

After tightening by hand, tighten additional 1/6 to 1/4 rotation with a tightening tool.

- For taper thread

Tighten with proper tightening torques below. Also, use pipe tape on the plug. With regard to the sunk dimension of a plug (dimension "a" in the figure), use the stipulated figures as a guide and confirm the air leakage before operation.

* If plugs on the top mounting port are tightened with more than the proper tightening torque, they will be screwed too deeply and the air passage will be constricted, resulting in limited cylinder speed.

Connection thread (plug) size	Applicable tightening torque (N·m)	a dimension
1/8	7 to 9	0.5 mm or less
1/4	12 to 14	1 mm or less
3/8	22 to 24	1 mm or less

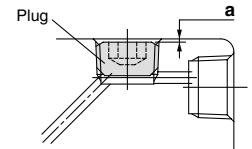

CLJ2

CLM2

CLG1

CL1

MLGC

CNG

MNB

CNA

CNS

CLS

CLQ

RLQ

MLU

MLGP

ML1C

D-□

-X□

Individual

-X□



Series MLGP Specific Product Precautions 3

Be sure to read before handling. Refer to front matters 42 and 43 for Safety Instructions and pages 3 to 11 for Actuator and Auto Switch Precautions.

Preparing for Operation

Warning

1. Before starting operation from the locked position, be sure to restore air pressure to the B port in the pneumatic circuit.

When pressure is not applied to the B port, the load may drop or the cylinder may eject at high speed, which is extremely dangerous. It may also damage the cylinder, greatly shorten the service life or cause unlocking malfunction. When applying pressure to the B port, be sure to confirm whether the environment is safe, since workpieces may move.

2. Since size $\varnothing 20$ through $\varnothing 32$ are shipped in an unlocked condition maintained by the unlocking bolt, be sure to remove the unlocking bolt following the steps below.

If the cylinder is used without removing the unlocking bolt, the lock mechanism will not function.

For $\varnothing 20$ through $\varnothing 32$ only

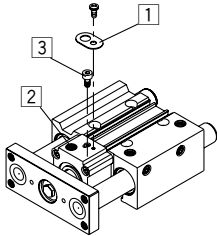

- 1) Confirm that there is no air pressure inside the cylinder, and remove the dust cover 1.
- 2) Supply air pressure of 0.2 MPa or more to unlocking port 2 shown in the drawing on the left.
- 3) Remove the unlocking bolt 3 with a hexagon wrench (width across flats 2.5).

Since a holding function for the unlocked state is not available for sizes $\varnothing 40$ through $\varnothing 100$, they can be used as shipped.

Manually Unlocking

Warning

1. Do not perform unlocking while an external force such as a load or spring force is being applied.

This is very dangerous because the cylinder will move suddenly. Release the lock after preventing cylinder movement with a lifting device such as a jack.

2. After confirming safety, operate the manual release following the steps shown below.

Carefully confirm that personnel are not inside the load movement range, etc., and that there is no danger even if the load moves suddenly.

Manually unlocking

For $\varnothing 20$ to $\varnothing 32$

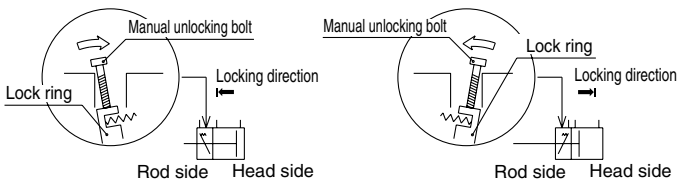

Extension locking

- 1) Remove the dust cover.
- 2) Screw a manual unlocking bolt (a bolt of M3 x 0.5 x 15 ℓ or more commercially available) into the lock ring threads as shown above, and lightly push the bolt in the direction of the arrow (head side) to unlock.

Retraction locking

- 1) Remove the dust cover.
- 2) Screw a manual unlocking bolt (a bolt of M3 x 0.5 x 15 ℓ or more commercially available) into the lock ring threads as shown above, and lightly push the bolt in the direction of the arrow (rod side) to unlock.

Manually Unlocking

Warning

For $\varnothing 40$ to $\varnothing 100$

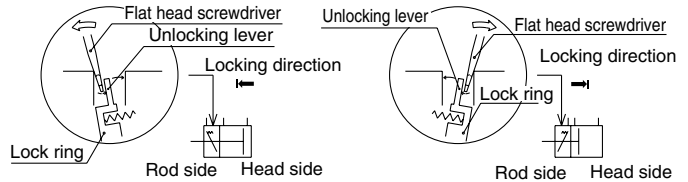

Extension locking

- 1) Remove the dust cover.
- 2) Insert a flat head screwdriver on the rod side of the manual unlocking lever as shown in the figure above, and lightly push the screwdriver in the direction of the arrow (rod side) to unlock.

Retraction locking

- 1) Remove the dust cover.
- 2) Insert a flat head screwdriver on the head side of the manual unlocking lever as shown in the figure above, and lightly push the screwdriver in the direction of the arrow (head side) to unlock.

Holding the Unlocked State ($\varnothing 20$ through $\varnothing 32$)

Caution

1. In order to hold the locked state, be sure to follow the steps below after confirming safety.

- 1) Remove the dust cover 1.
- 2) Supply air pressure of 0.2 MPa or more to the unlocking port 2 shown below and unlock.
- 3) Screw the attached hexagon socket head cap bolt 3 ($\varnothing 20$, $\varnothing 25$: M3 x 0.5 x 5 ℓ , $\varnothing 32$: M3 x 0.5 x 10 ℓ), into the lock ring to hold the unlocked condition.

2. To use the lock mechanism again, be sure to remove the unlocking bolt.

When the unlocking bolt is screwed in, the lock mechanism does not function. Remove the unlocking bolt according to the steps prescribed in the section of "Preparing for Operation".

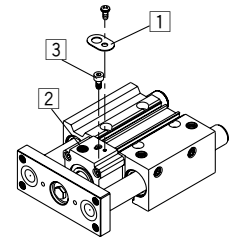

Maintenance

Caution

1. In order to maintain good performance, operate with clean unlubricated air.

If lubricated air, compressor oil or drainage, etc., enter the cylinder, there is a danger of sharply reducing the locking performance.

2. Do not apply grease to the piston rod. There is a danger of sharply reducing the locking performance.
3. $\varnothing 20$ to $\varnothing 32$, a $\varnothing 12$ silver seal is labeled on the one surface of the lock body (on the surface opposite from the unlocking port). The seal is meant for dust prevention, but even if it is peeled off, there would be no problem functionally.
4. Never disassemble the lock unit.

It contains a heavy duty spring which is dangerous and there is also a danger of reducing the locking performance.

Series MLGP Model Selection

Precautions on Model Selection

⚠ Caution

1. In order that the originally selected maximum speed shall be not exceeded, be certain to use a speed controller to adjust the total movement distance of the load so that movement takes place in no less than the applicable movement time.
2. For an intermediate stroke product with spacers installed, select using the base model stroke.

Step (1) Find the maximum load speed V.

Find the maximum load speed V [mm/s] with following formula (1) below.
The maximum load speed V [mm/s] is approximately equal to $V_1 \times 1.4 \dots(1)$

V_1 : Average load speed [mm/s]
 $V_1 = st/t$
st: Load transfer distance [mm]
t: Load transfer time [s]

Step (2) Find the bore size.

1. For vertical mounting

- 1) From Table 1, find applicable selection graphs based on the maximum load speed "V", mounting orientation, and bearing type.
- 2) From the graphs chosen in (1), select the appropriate graph based on the stroke, and then find the intersecting point of the load mass "m" and eccentric distance " ℓ_1 ".
- 3) Compare the intersecting point with the line chart for the operating pressure "P". Select the bore size from the line chart above the intersecting point.

2. For horizontal mounting

- 1) From Table 1, find applicable selection graphs based on the maximum load speed "V" and bearing type.
- 2) From the graphs chosen in (1), select the appropriate graph based on the distance " ℓ_2 " between the plate and load center of gravity, then find the intersecting point of the load mass "m" and stroke.
- 3) Compare the intersecting point with the line chart. Select the bore size from the line chart above the intersecting point.

Selection Conditions/Table (1)

Mounting orientation	Vertical				Horizontal	
	Upward facing		Downward facing			
Maximum load speed V	50 to 200 mm/s	201 to 400 mm/s	50 to 200 mm/s	201 to 400 mm/s	50 to 200 mm/s	201 to 400 mm/s
Graph (Slide bearing type)	(1), (2)	(3), (4)	(13), (14)	(15), (16)	(25), (26)	(27), (28)
Graph (Ball bushing bearing type)	(5) to (8)	(9) to (12)	(17) to (20)	(21) to (24)	(29), (30)	(31), (32)

· When the maximum speed exceeds 200 mm/s, the allowable load mass is determined by multiplying the value shown in the graph at 400 mm/s by the coefficient listed in the table below.

Max. speed	Up to 300 mm/s	Up to 400 mm/s
Coefficient	1.7	1

CLJ2

CLM2

CLG1

CL1

MLGC

CNG

MNB

CNA

CNS

CLS

CLQ

RLQ

MLU

MLGP

ML1C

D--XIndividual
-X

Series MLGP

Selection Example 1 (Vertical Upward Mounting)

Selection conditions

Mounting: Vertical upward facing
 Bearing type: Ball bushing
 Stroke: 50 mm
 Load transfer time t : 0.5 s
 Load mass m : 15 kg
 Eccentric distance ℓ_1 : 50 mm
 Operating pressure P : 0.5 MPa

Step 1: Find the maximum load speed "V" from formula (1).

Based on the stroke (load transfer distance) of 50 mm and load transfer time of 0.5 s, the maximum load speed is approximately equal to $50/0.5 \times 1.4$, which is approximately 140 mm/s.

Step 2: Based on the maximum load speed found in Step 1, mounting orientation, and guide type, graphs (5) to (8) are selected. Then, based on the 50 mm stroke, graph (7) is selected from the group. Find the intersecting point of the load mass of 15 kg and the eccentric distance of 50 mm. Since the operating pressure is 0.5 MPa, the bore size of $\phi 80$ mm, model MLGPL80-50-B, is selected.

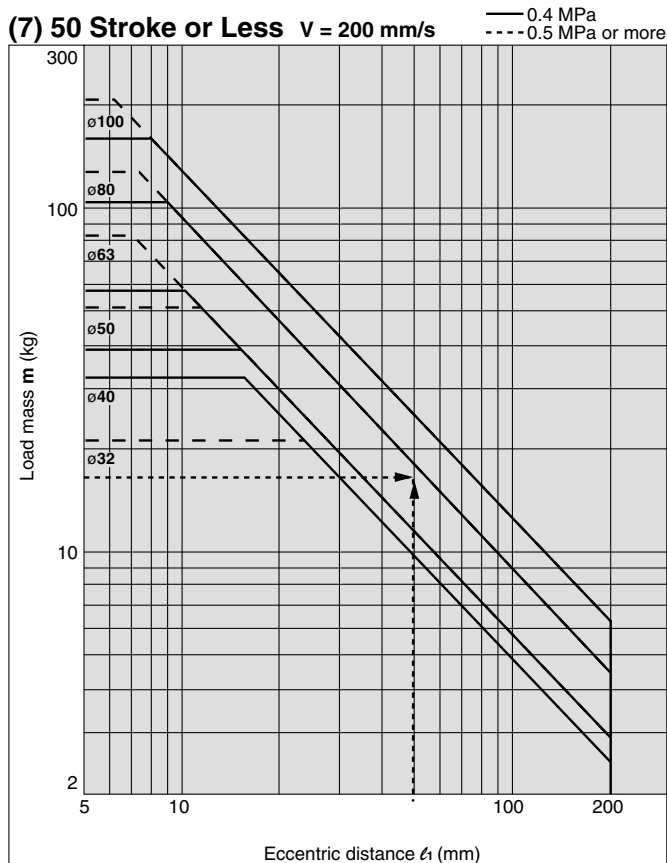

Selection Example 2 (Horizontal Mounting)

Selection conditions

Mounting: Horizontal
 Bearing type: Slide bearing
 Stroke: 100 mm
 Load transfer time t : 0.35 s
 Load mass m : 6 kg
 Eccentric distance between the plate and load center of gravity ℓ_2 : 50 mm
 Operating pressure P : 0.4 MPa

Step 1: Find the maximum load speed "V" from formula (1).

Based on the stroke (load transfer distance) of 100 mm and load transfer time of 0.35 s, the maximum load speed is approximately equal to $100/0.35 \times 1.4$, which is approximately 400 mm/s.

Step 2: Based on the maximum load speed found in Step 1, mounting orientation, and guide type, graphs (27) and (28) are selected. Then, based on the distance of 50 mm between the plate and load center of gravity, graph (27) is selected from the two graphs. Find the intersecting point of the load mass of 6 kg and the 100 mm stroke. The bore size of $\phi 40$ mm, model MLGPM40-50-□, is selected.

(27) $\ell_2 = 50$ mm $V = 400$ mm/s Horizontal Mounting

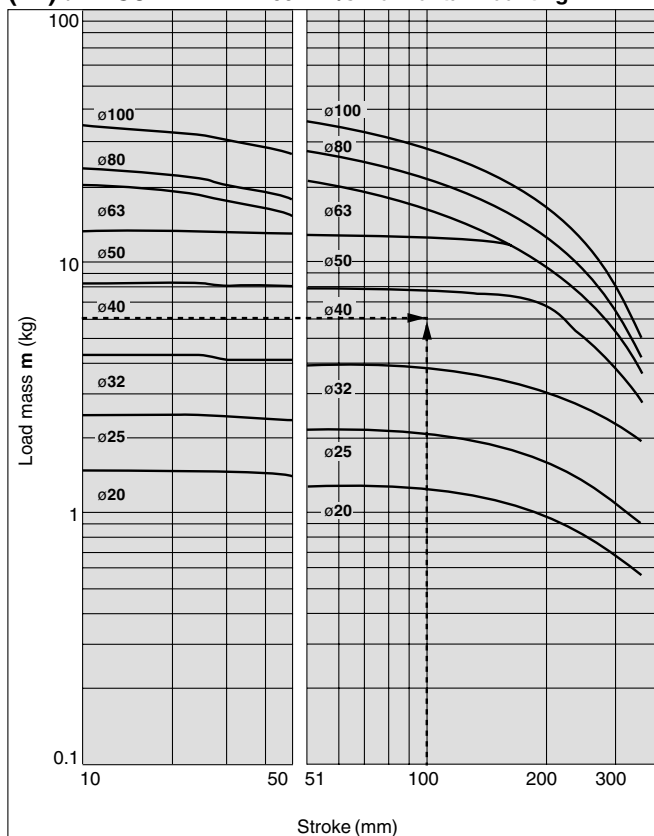

Vertical Upward Mounting (Slide Bearing)

— Operating pressure 0.4 MPa
 - - - - - Operating pressure 0.5 MPa or more

MLGPM20 to 100

(1) 50 Stroke or Less $v = 200 \text{ mm/s}$

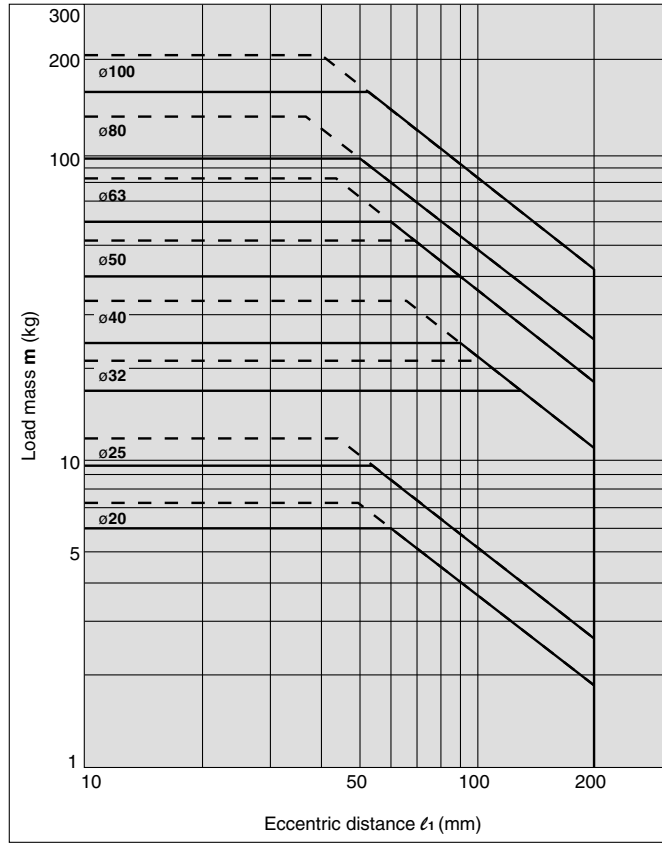

(2) Over 50 Stroke $v = 200 \text{ mm/s}$

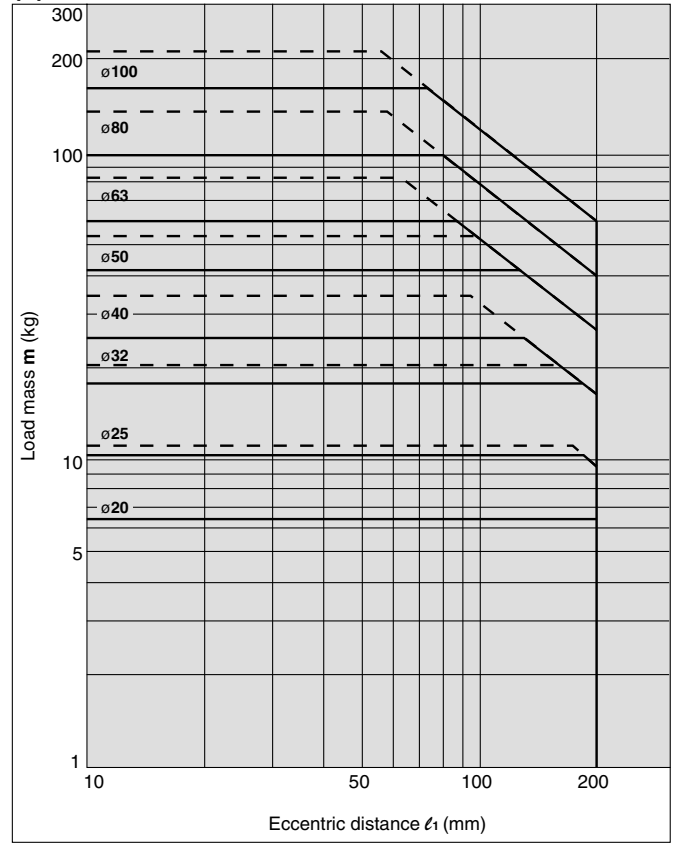

(3) 50 Stroke or Less $v = 400 \text{ mm/s}$

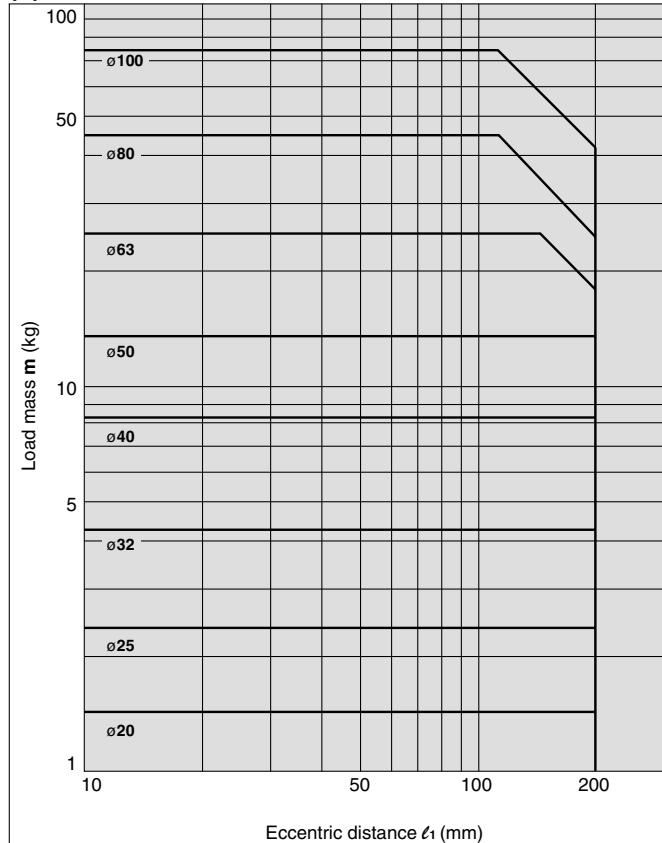

(4) Over 50 Stroke $v = 400 \text{ mm/s}$

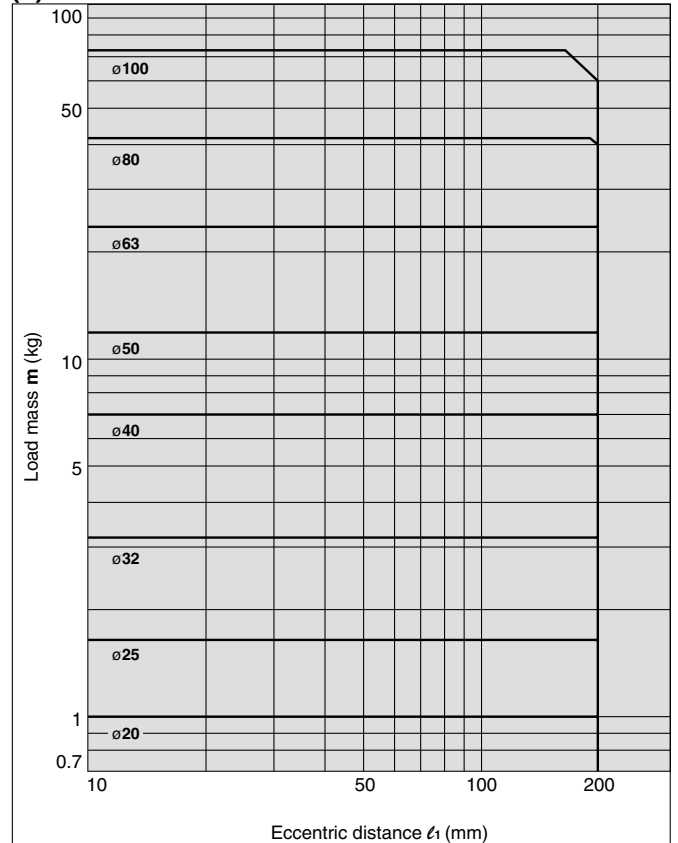

CLJ2

CLM2

CLG1

CL1

MLGC

CNG

MNB

CNA

CNS

CLS

CLQ

RLQ

MLU

MLGP

ML1C

D-□

-X□

Individual
-X□

Series MLGP

Vertical Upward Mounting (Ball Bushing Bearing)

— Operating pressure 0.4 MPa
 - - - - - Operating pressure 0.5 MPa or more

MLGPL20, 25

(5) 30 Stroke or Less $V = 200$ mm/s

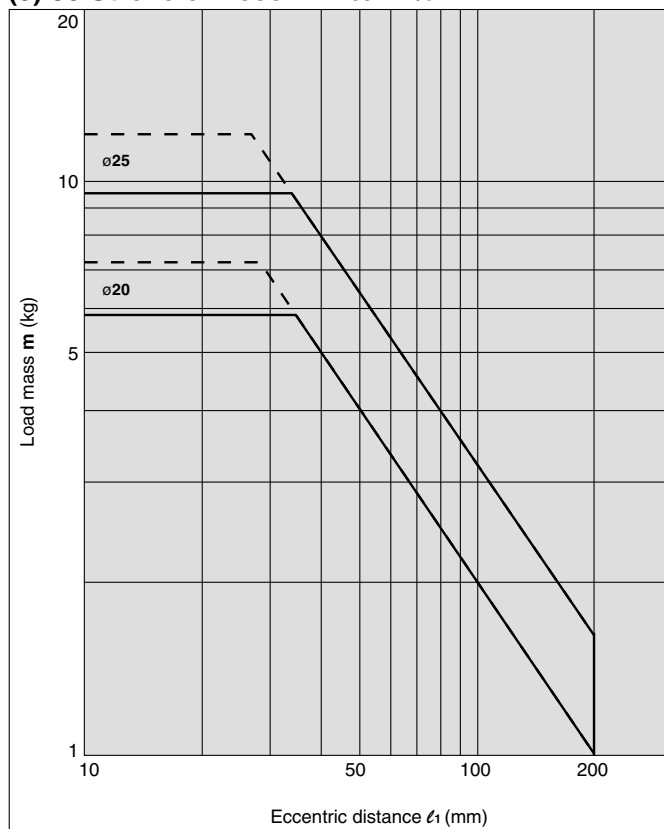

(6) Over 30 stroke $V = 200$ mm/s

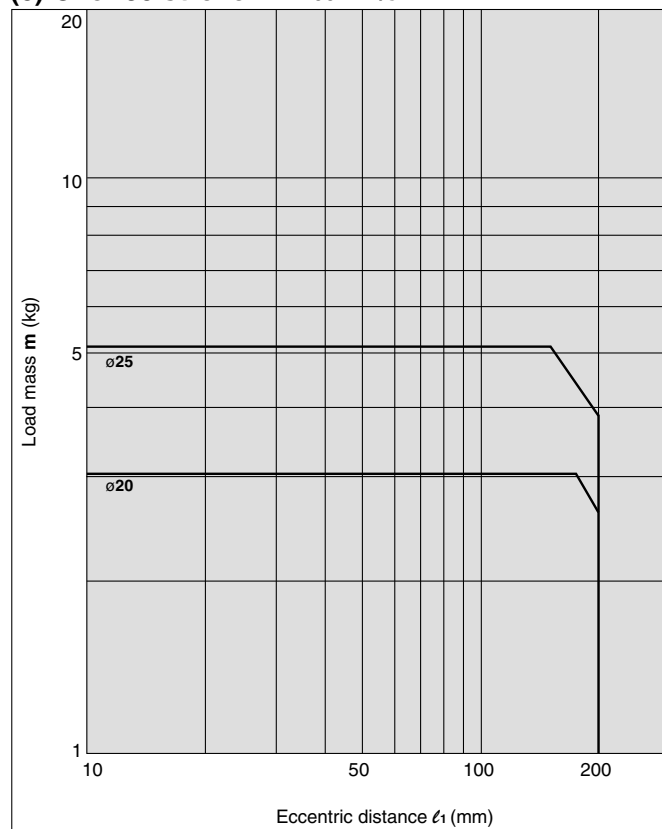

MLGPL32 to 100

(7) 50 Stroke or Less $V = 200$ mm/s

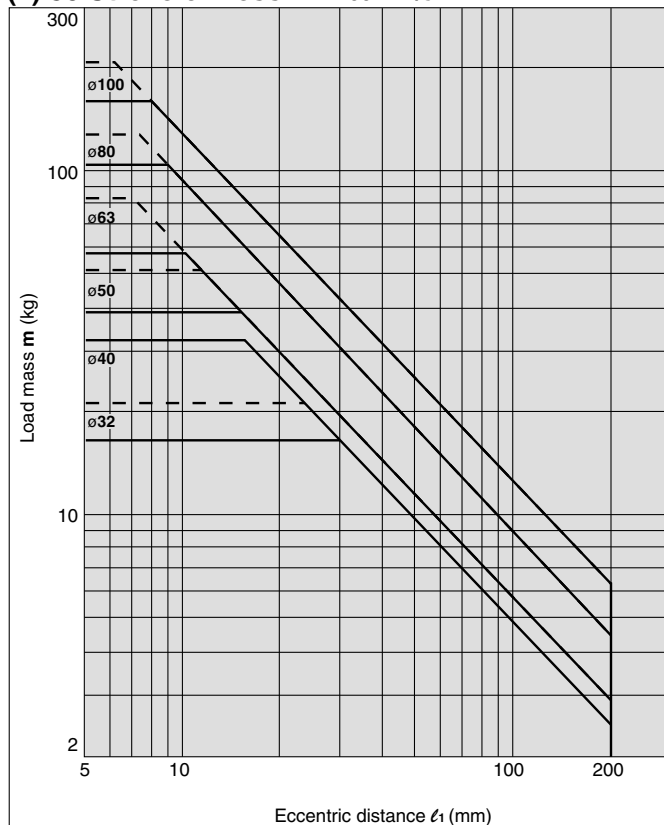

(8) Over 50 Stroke $V = 200$ mm/s

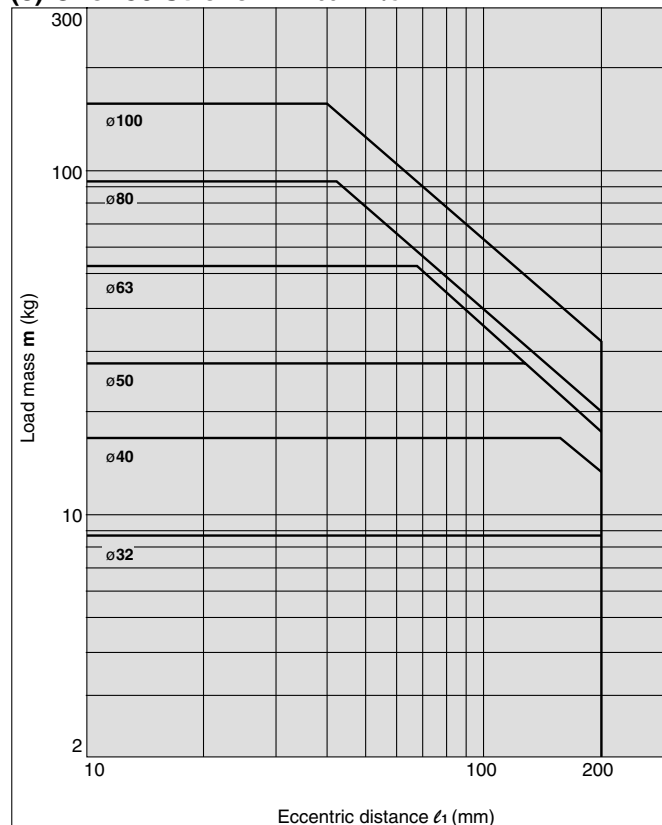

Vertical Upward Mounting (Ball Bushing Bearing)

Operating pressure: 0.4 MPa

MLGPL20, 25

(9) 30 Stroke or Less V = 400 mm/s

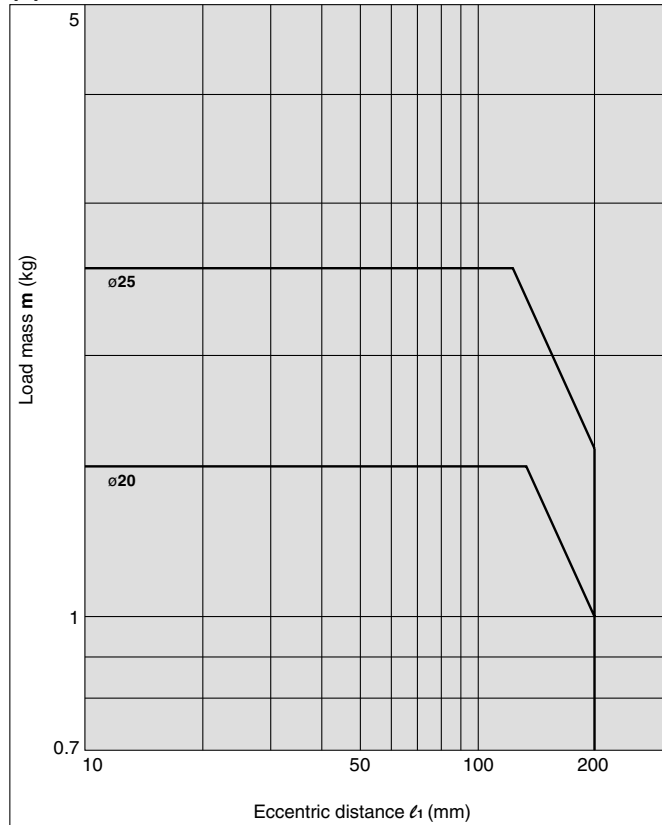

(10) Over 30 Stroke V = 400 mm/s

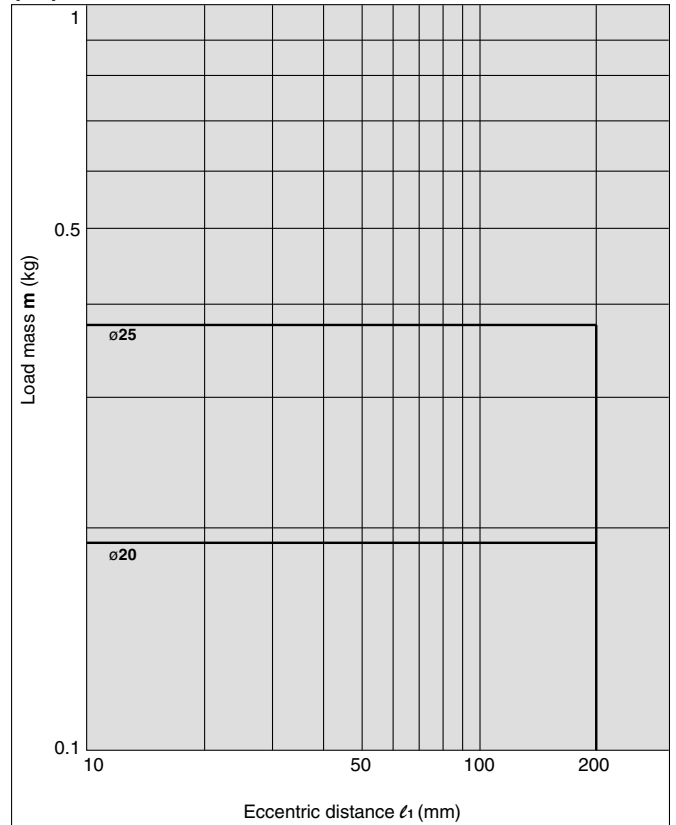

MLGPL32 to 100

(11) 50 Stroke or Less V = 400 mm/s

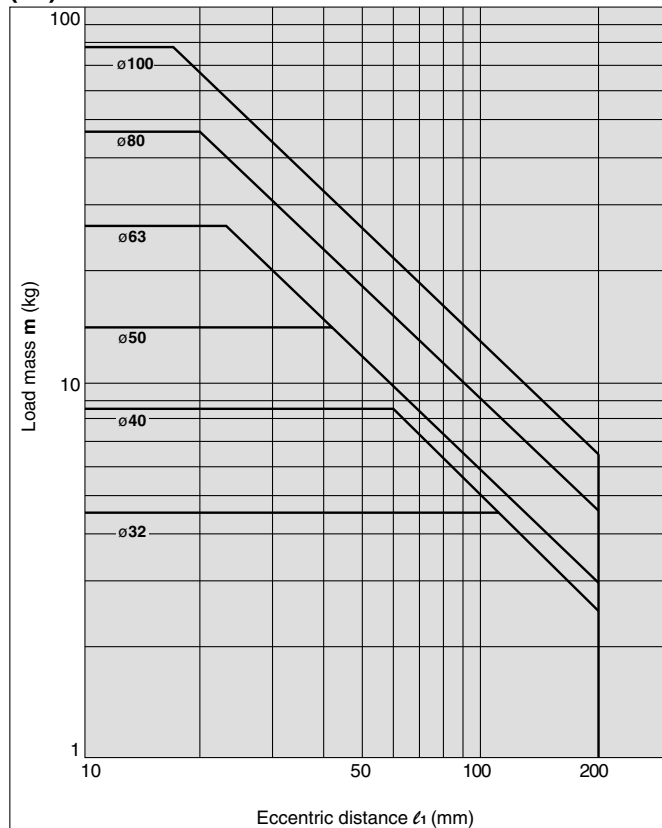

(12) Over 50 Stroke V = 400 mm/s

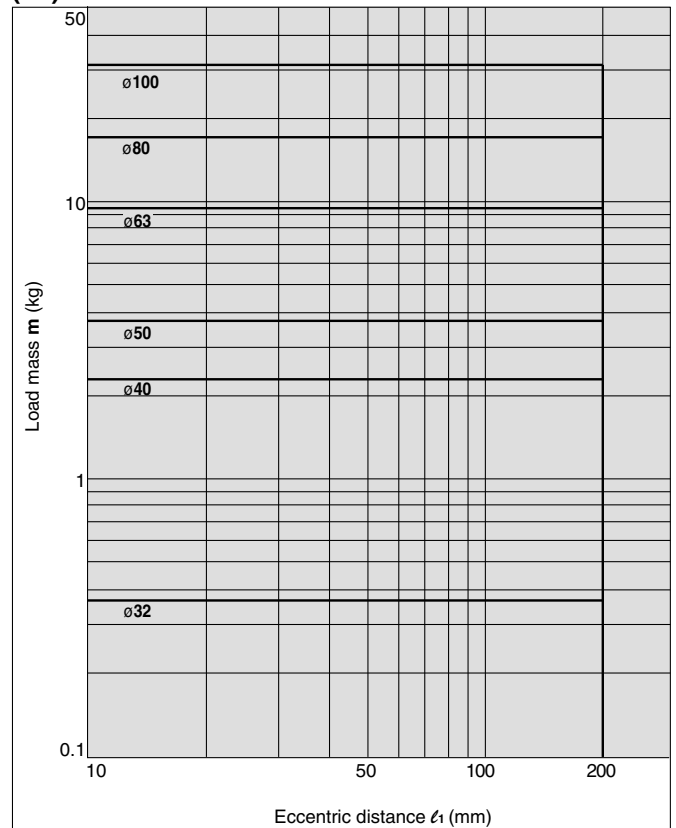

CLJ2

CLM2

CLG1

CL1

MLGC

CNG

MNB

CNA

CNS

CLS

CLQ

RLQ

MLU

MLGP

ML1C

D-□

-X□

Individual
-X□

Series MLGP

Vertical Downward Mounting (Slide Bearing)

—— Operating pressure 0.4 MPa
 - - - - - Operating pressure 0.5 MPa or more

MLGPM20 to 100

(13) 50 Stroke or Less $V = 200 \text{ mm/s}$

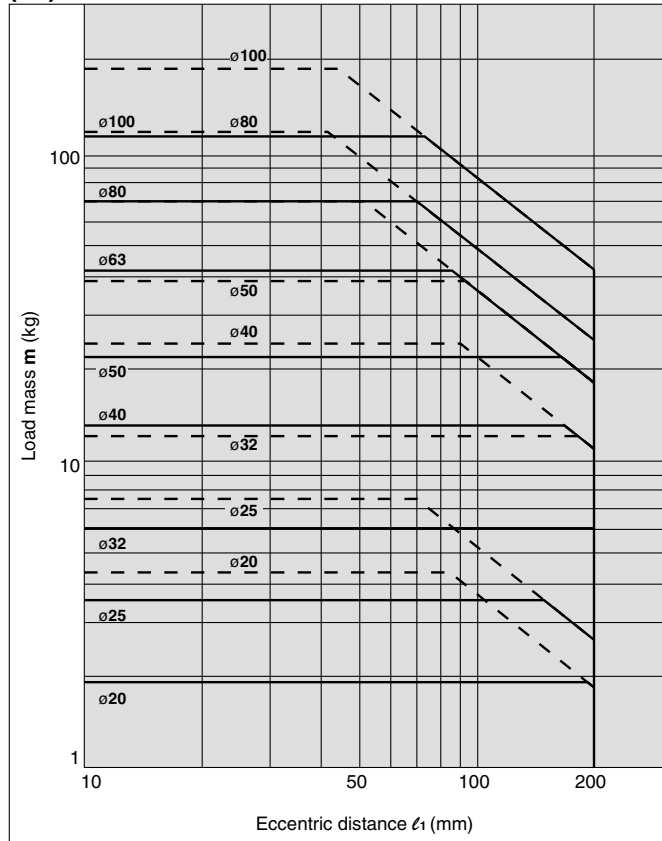

(14) Over 50 Stroke $V = 200 \text{ mm/s}$

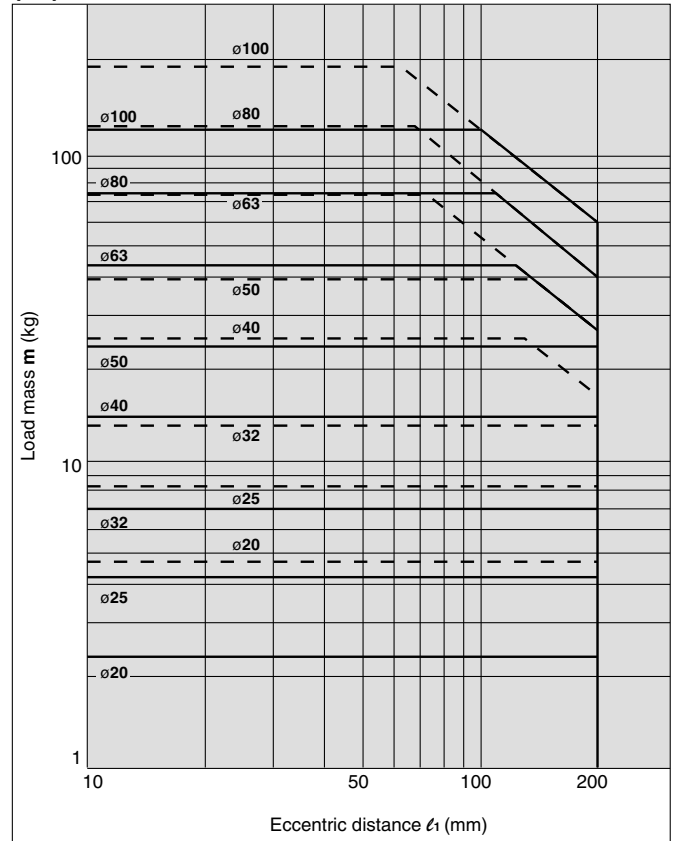

(15) 50 Stroke or Less $V = 400 \text{ mm/s}$

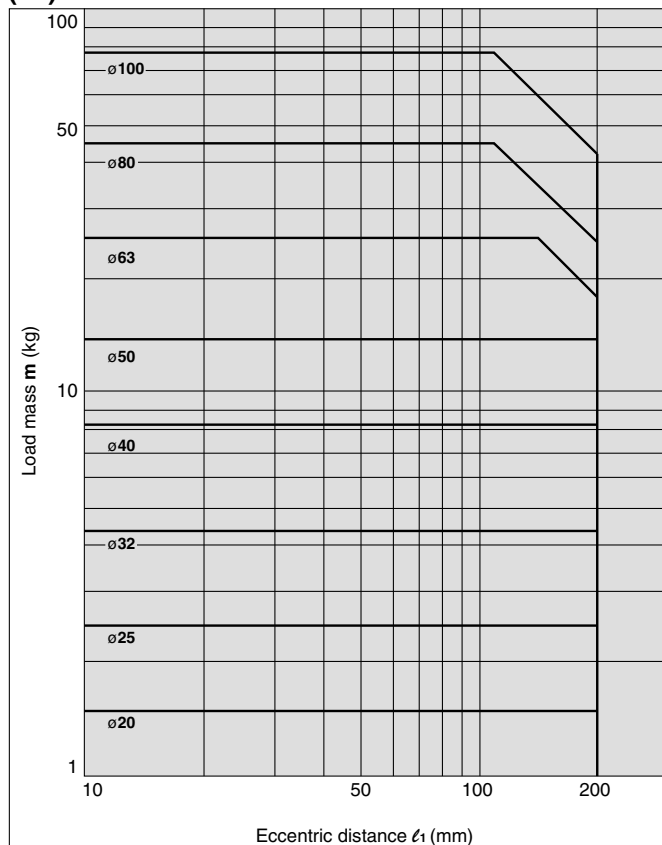

(16) Over 50 Stroke $V = 400 \text{ mm/s}$

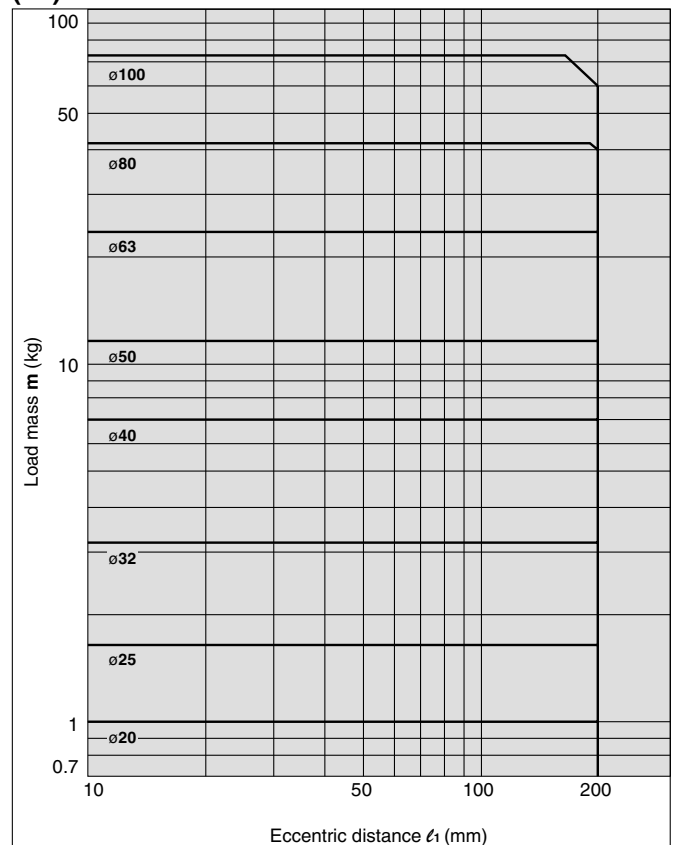

Vertical Downward Mounting (Ball Bushing Bearing)

— Operating pressure 0.4 MPa
 - - - - - Operating pressure 0.5 MPa or more

MLGPL20, 25

(17) 30 Stroke or Less $V = 200 \text{ mm/s}$

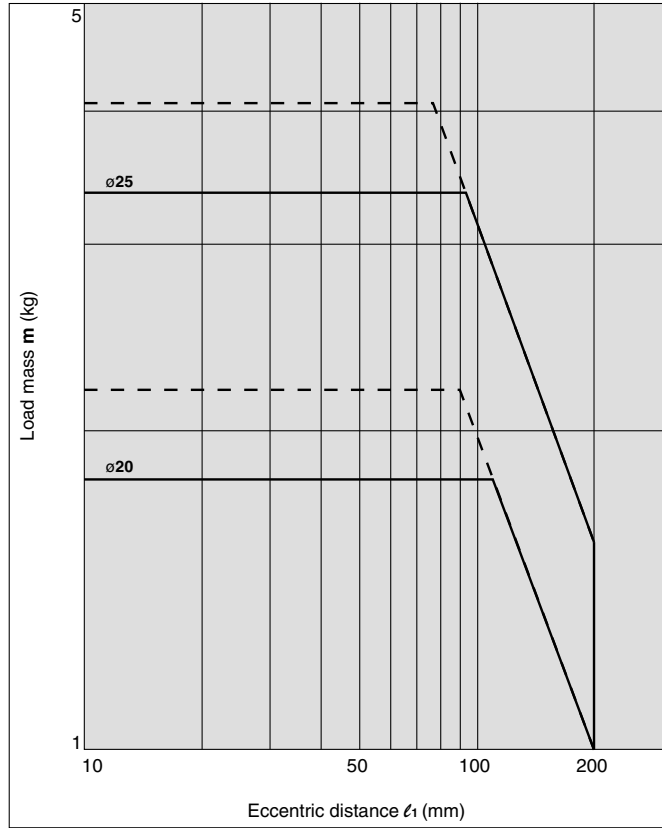

(18) Over 30 Stroke $V = 200 \text{ mm/s}$

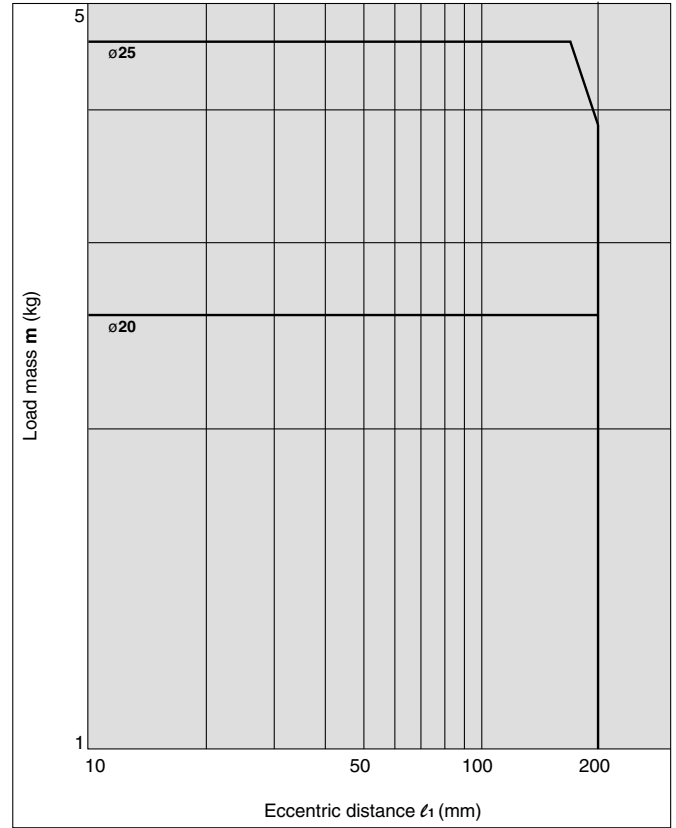

MLGPL32 to 100

(19) 50 Stroke or Less $V = 200 \text{ mm/s}$

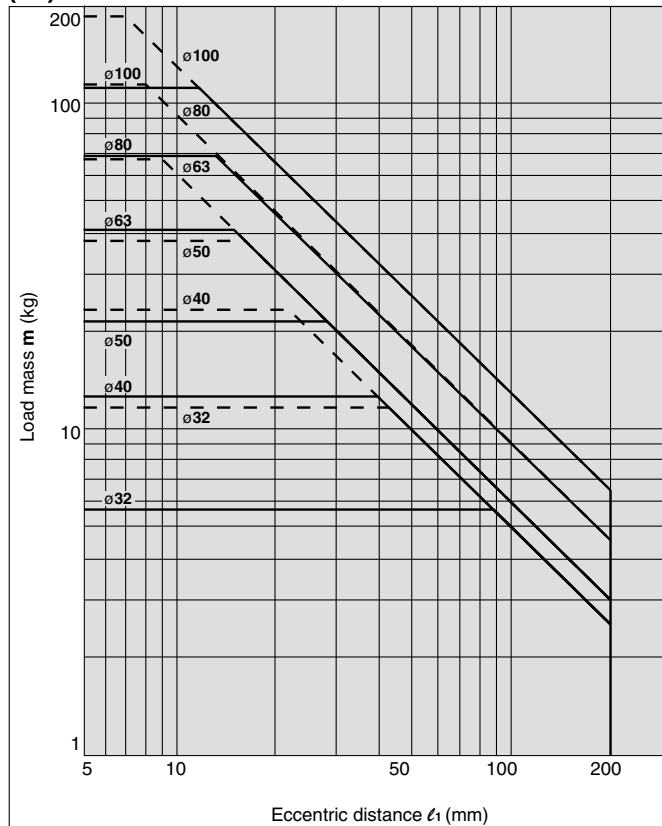

(20) Over 50 Stroke $V = 200 \text{ mm/s}$

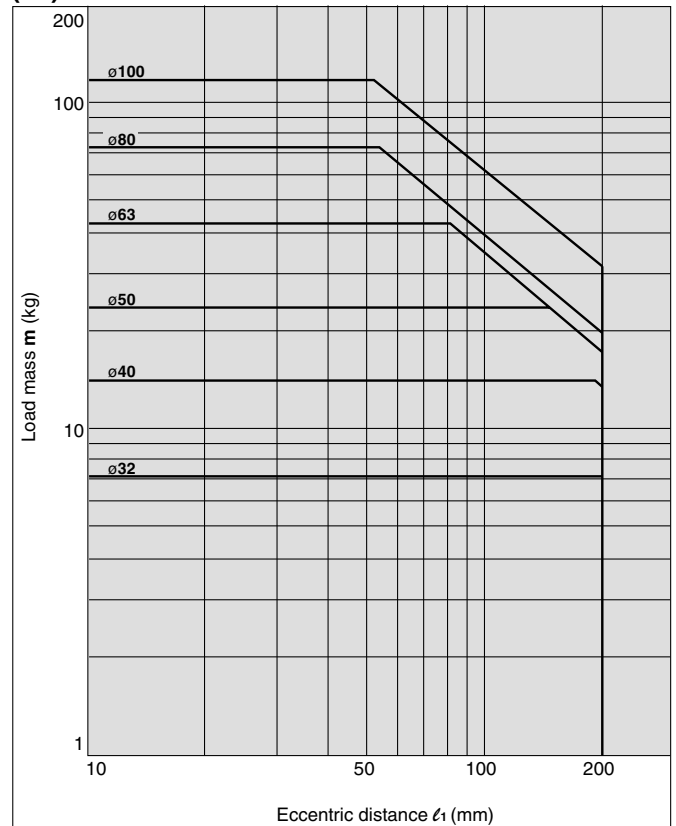

CLJ2

CLM2

CLG1

CL1

MLGC

CNG

MNB

CNA

CNS

CLS

CLQ

RLQ

MLU

MLGP

ML1C

D-□

-X□

Individual

-X□

Series MLGP

Vertical Downward Mounting (Ball Bushing Bearing)

Operating pressure: 0.4 MPa

MLGPL20, 25

(21) 30 Stroke or Less $V = 400 \text{ mm/s}$

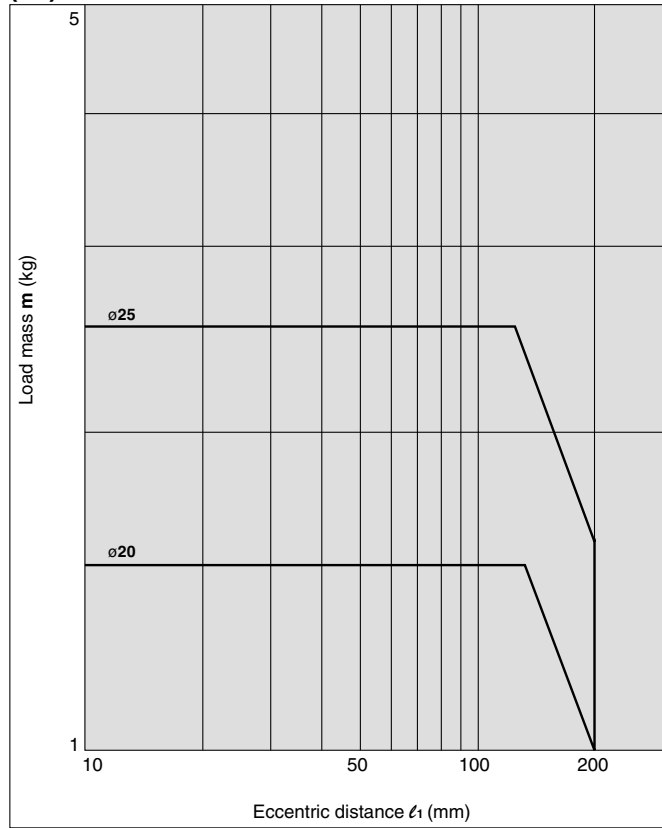

(22) Over 30 Stroke $V = 400 \text{ mm/s}$

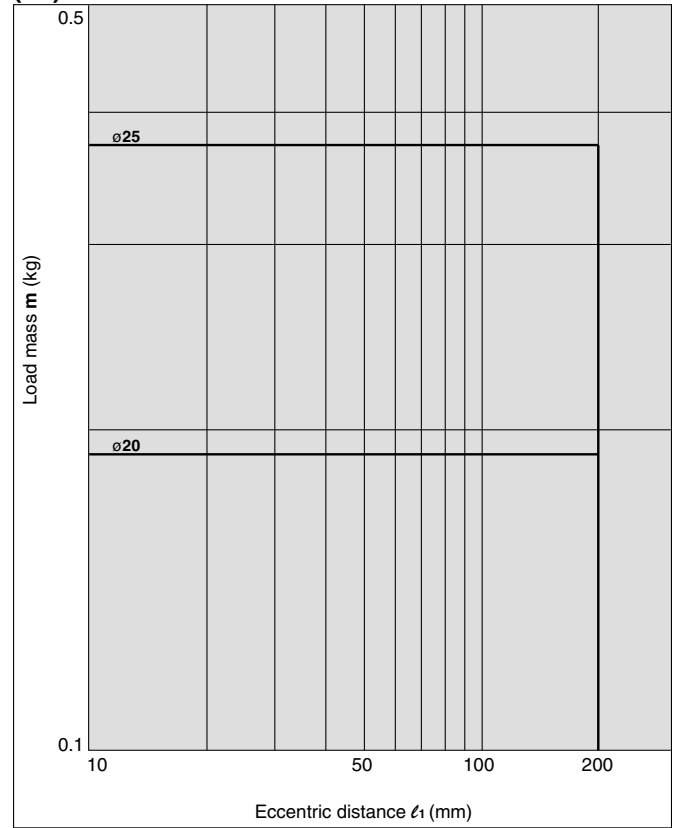

MLGPL32 to 100

(23) 50 Stroke or Less $V = 400 \text{ mm/s}$

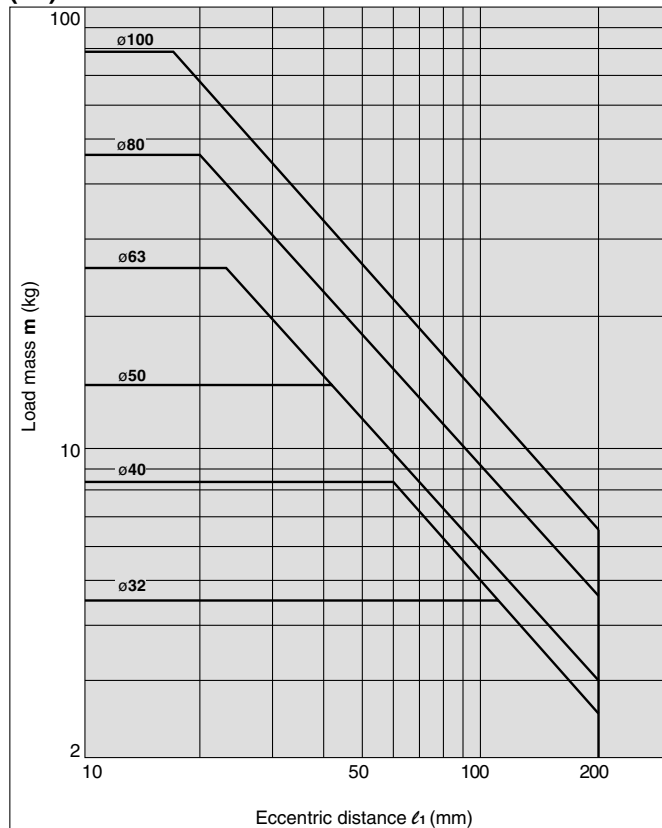

(24) Over 50 Stroke $V = 400 \text{ mm/s}$

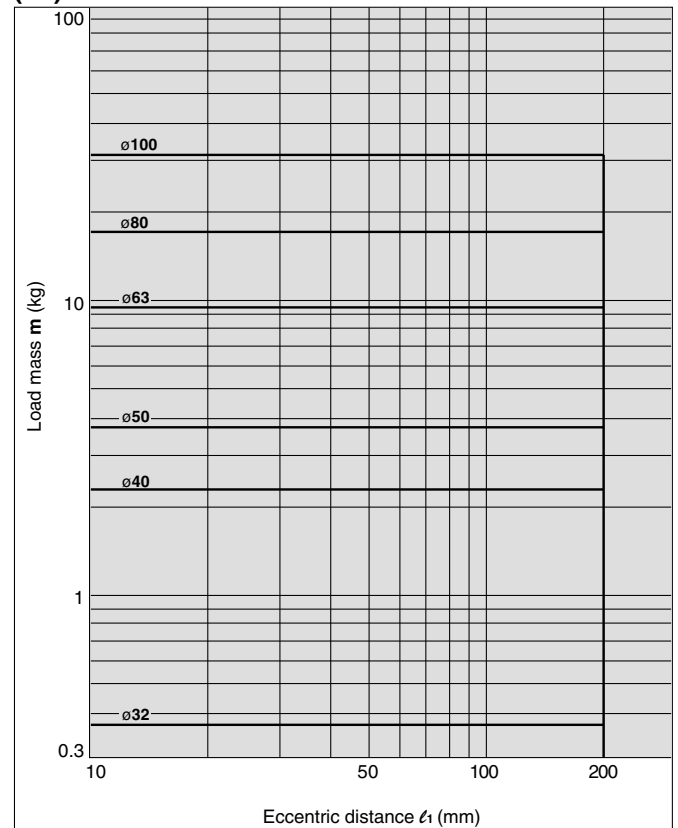

Horizontal Mounting (Slide Bearing)

MLGPM20 to 100

(25) $\ell_2 = 50 \text{ mm}$ $V = 200 \text{ mm/s}$

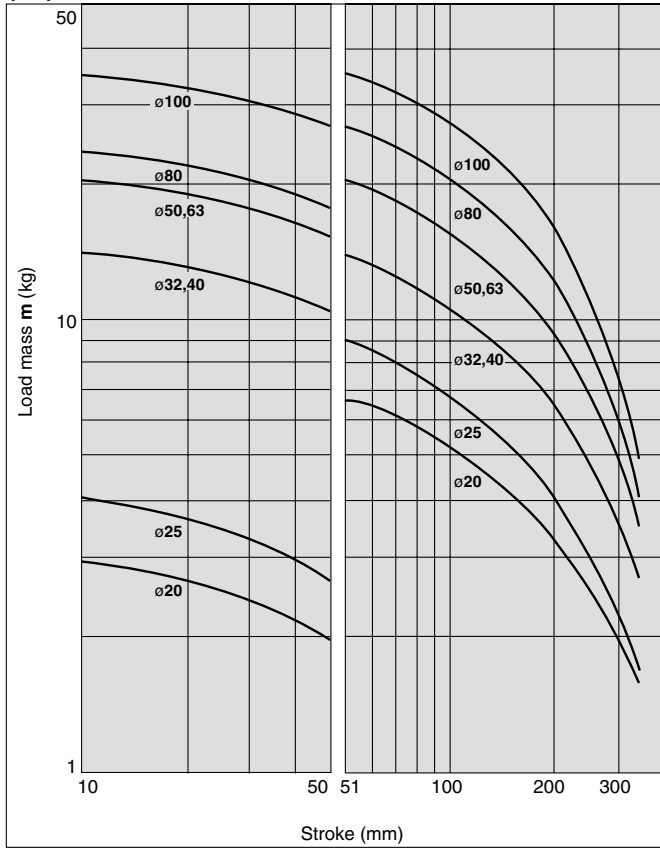

(26) $\ell_2 = 100 \text{ mm}$ $V = 200 \text{ mm/s}$

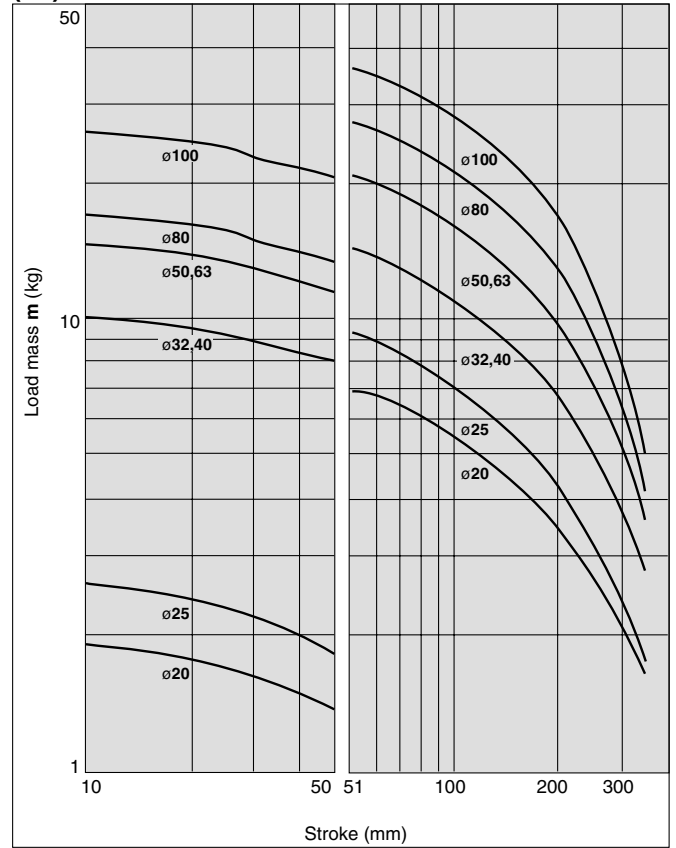

(27) $\ell_2 = 50 \text{ mm}$ $V = 400 \text{ mm/s}$

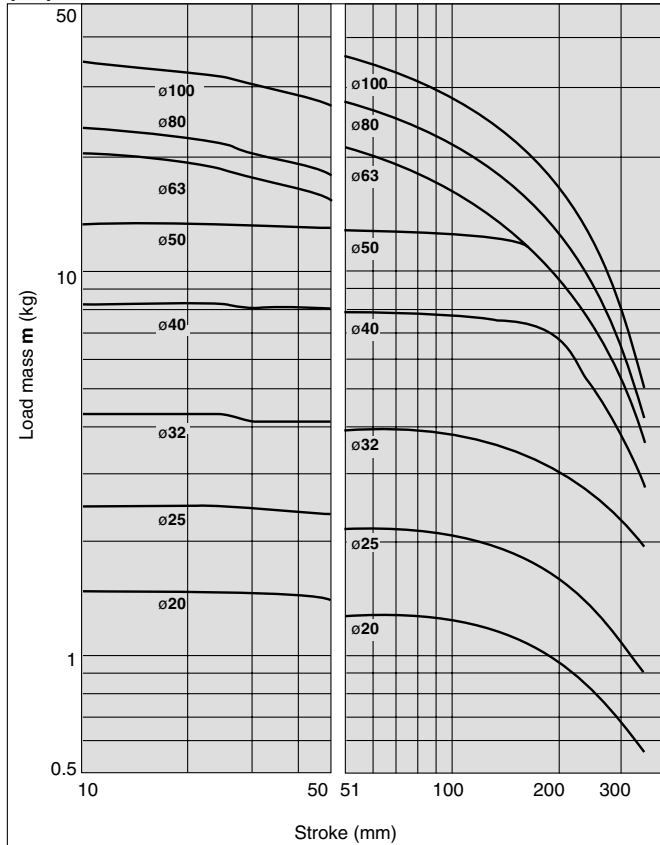

(28) $\ell_2 = 100 \text{ mm}$ $V = 400 \text{ mm/s}$

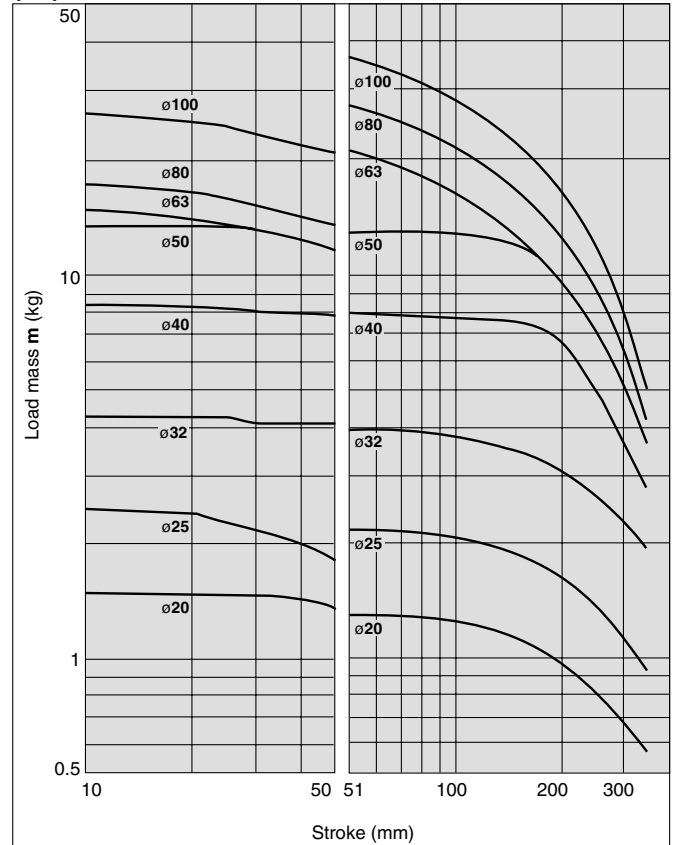

CLJ2

CLM2

CLG1

CL1

MLGC

CNG

MNB

CNA

CNS

CLS

CLQ

RLQ

MLU

MLGP

ML1C

D-

-X

Individual
-X

Series MLGP

Horizontal Mounting (Ball Bushing Bearing)

(29) $l_2 = 50 \text{ mm}$ $V = 200 \text{ mm/s}$

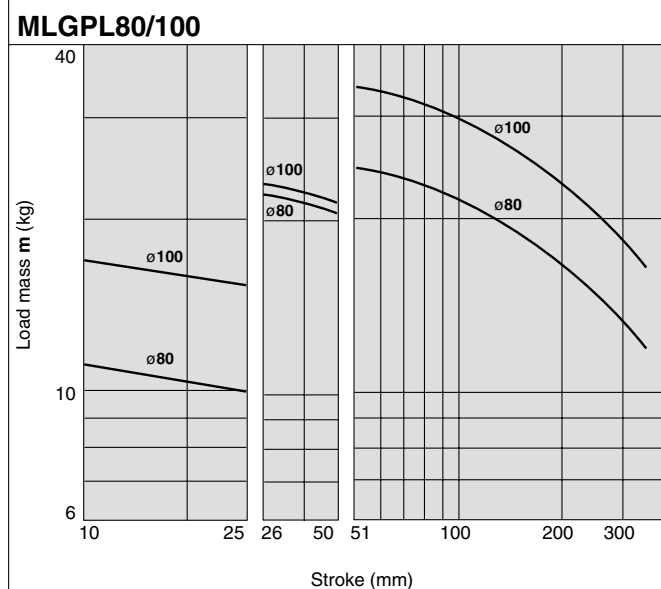
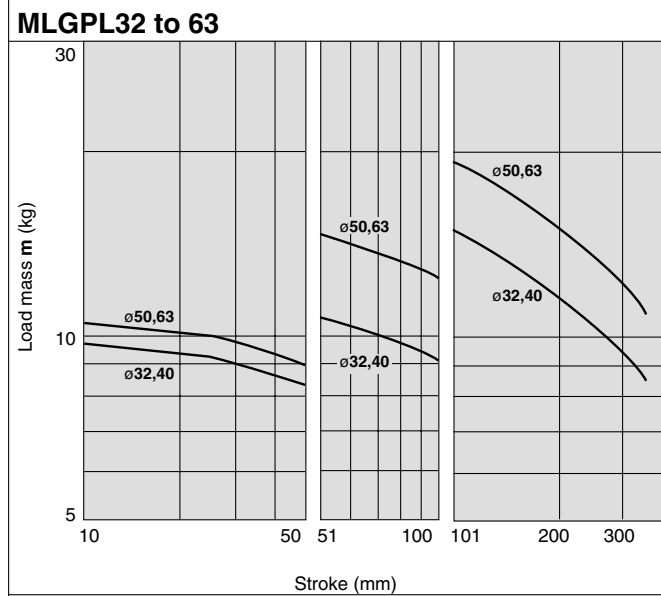
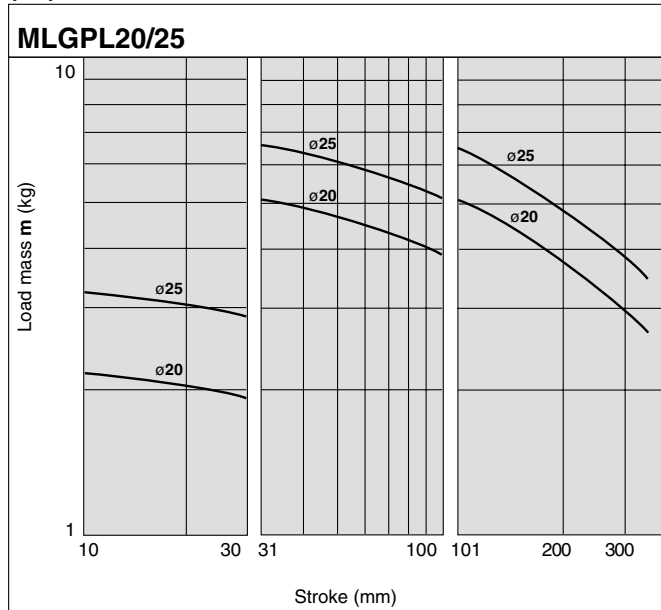

(30) $l_2 = 100 \text{ mm}$ $V = 200 \text{ mm/s}$

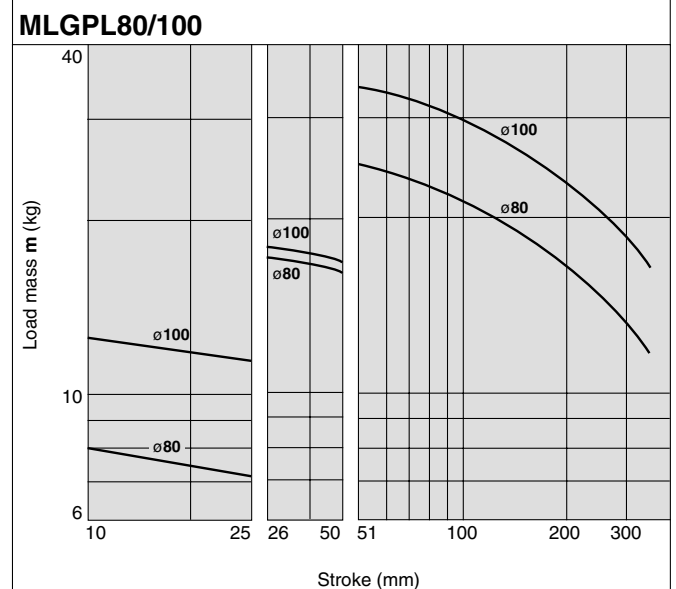
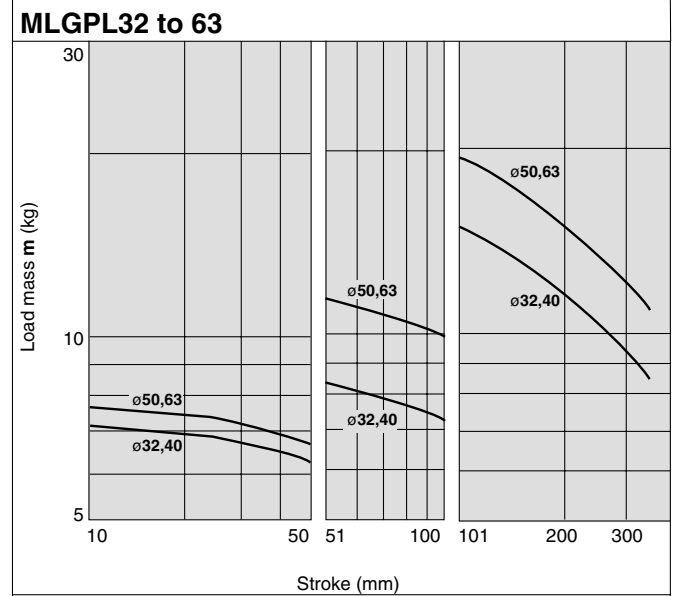
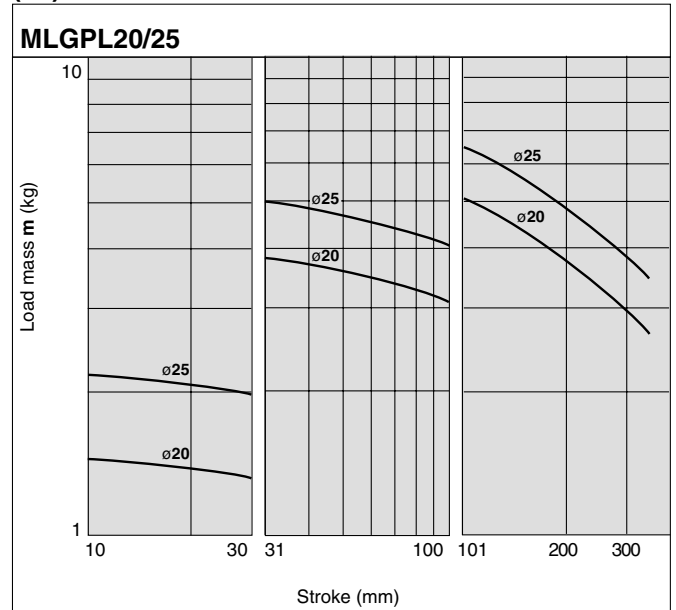

Horizontal Mounting (Ball Bushing Bearing)

(31) $l_2 = 50 \text{ mm}$ $V = 400 \text{ mm/s}$

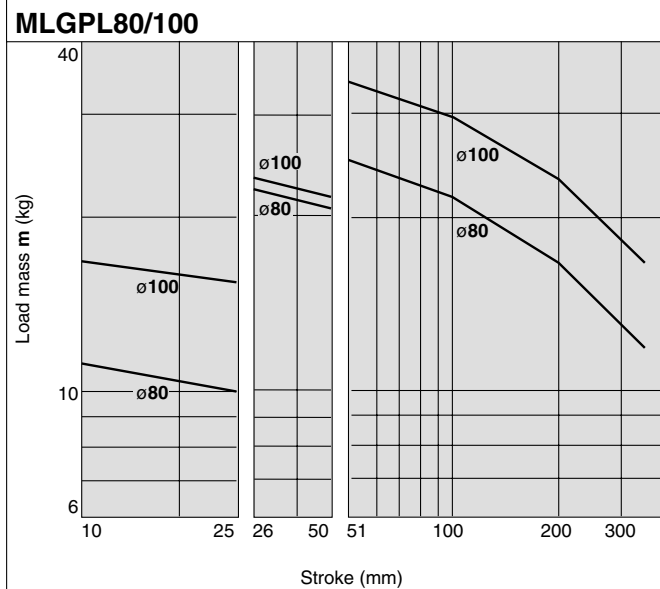
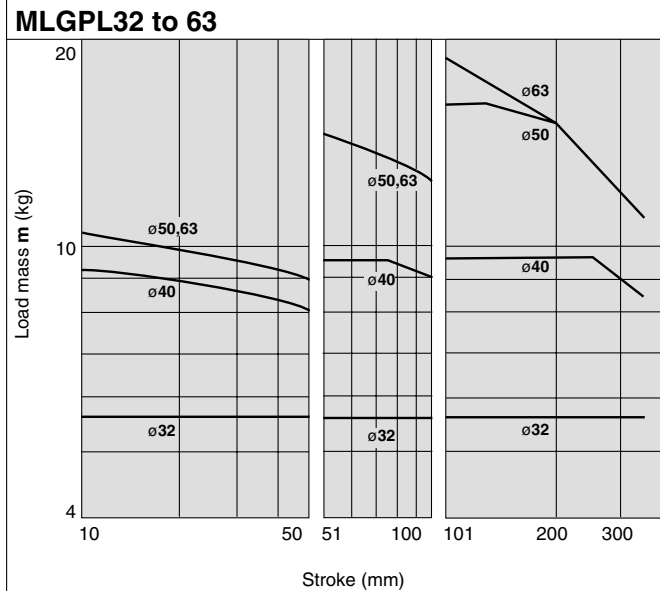
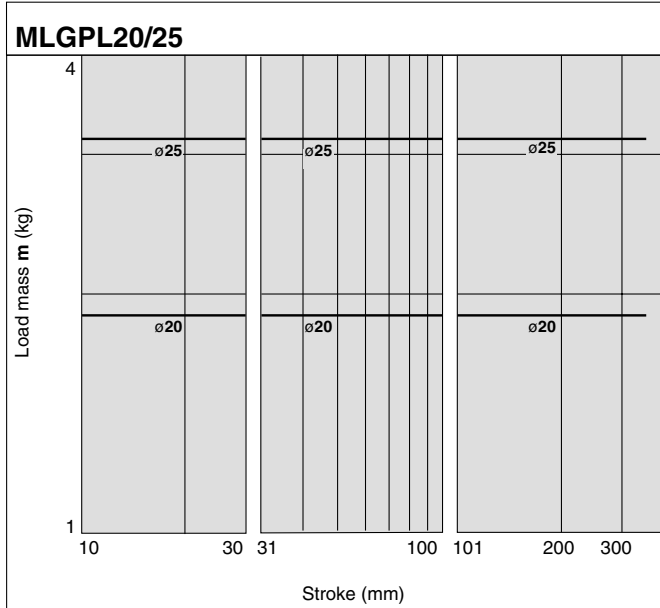

(32) $l_2 = 100 \text{ mm}$ $V = 400 \text{ mm/s}$

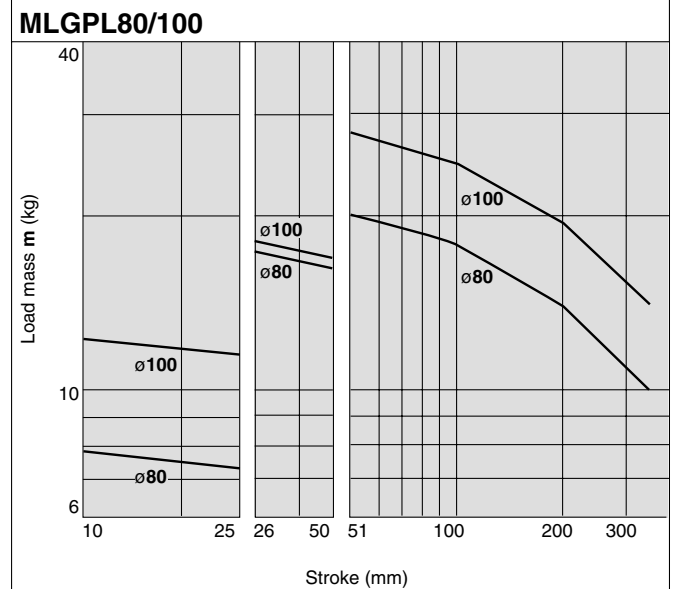
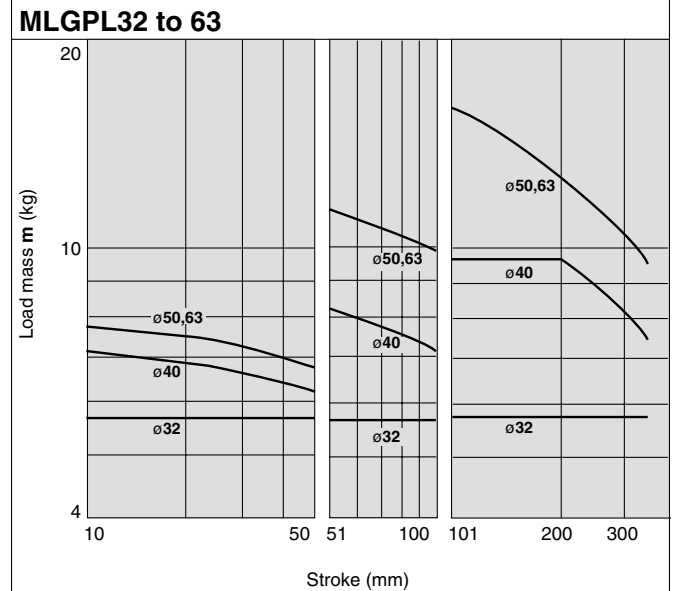
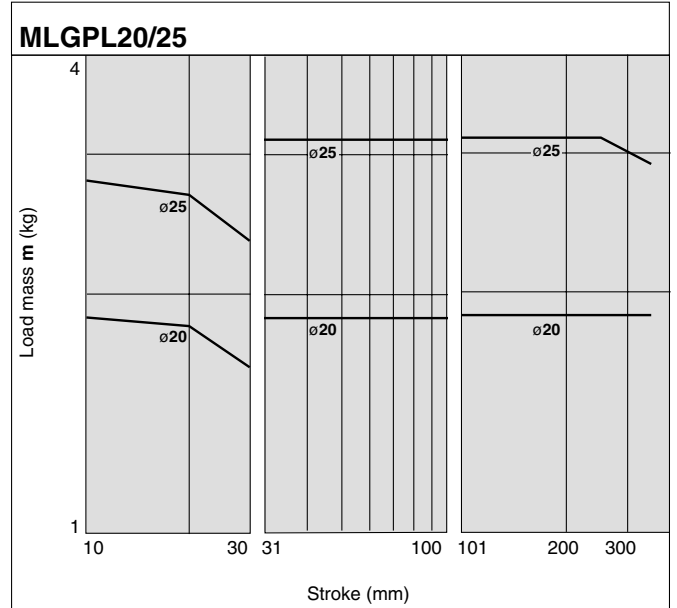

- CLJ2
- CLM2
- CLG1
- CL1
- MLGC
- CNG
- MNB
- CNA
- CNS
- CLS
- CLQ
- RLQ
- MLU
- MLGP
- ML1C

- D-
- X
- Individual
- X

Operating Range when Used as Stopper

⚠ Warning

- When using the cylinder as a stopper, do not allow workpieces to collide in the locked condition. If workpieces collide in the locked condition, the lock may disengage due to the shock, or the lock mechanism and piston rod may be damaged, causing a dramatic decrease of the product life and/ or further damage.
- Model MLGPL (Ball bushing bearing) cannot be used as a stopper.
When MLGPL (Ball bushing bearing) is used as a stopper, the impact will cause damage to the bearing unit and guide rod.
- Adopt the pneumatic circuit on page 884 when it's used as a stopper, so that workpiece does not collide in a lock state.

⚠ Caution

- When using as a stopper, select a model with 25 stroke or less for bore sizes $\phi 20$ and $\phi 25$, and 50 stroke or less for bore sizes $\phi 32$ to $\phi 100$.
- When selecting a model with a longer ℓ dimension, be sure to choose a bore size which is sufficiently large.

Bore size $\phi 20$, $\phi 25$ /MLGPM20/25 (Slide bearing)

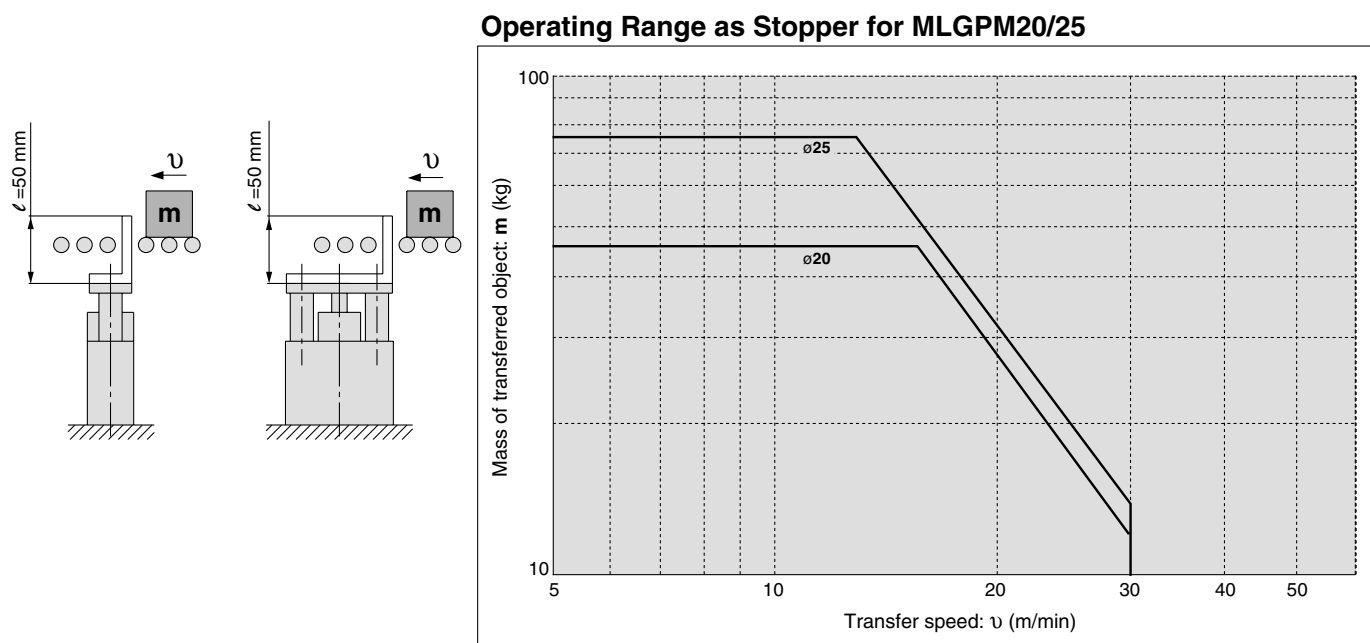

Bore size $\phi 32$ to $\phi 100$ /MLGPM32 to 100 (Slide bearing)

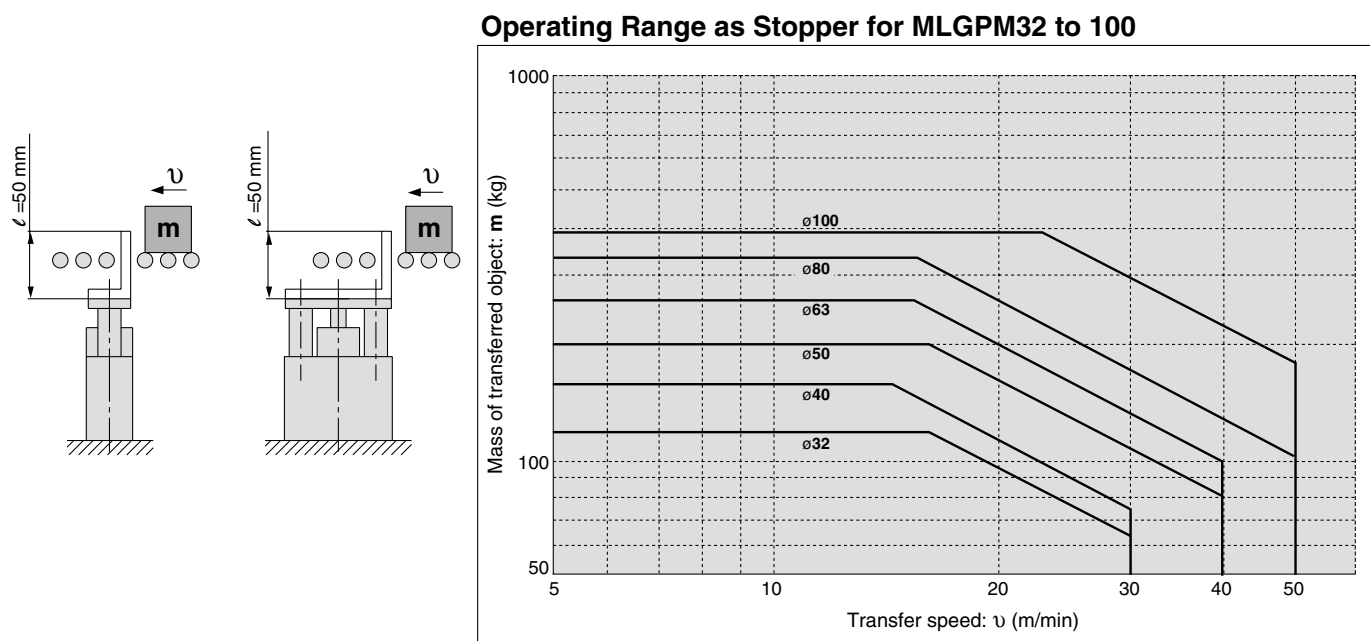

Compact Guide Cylinder with Lock

Series *MLGP*

ø20, ø25, ø32, ø40, ø50, ø63, ø80, ø100

How to Order

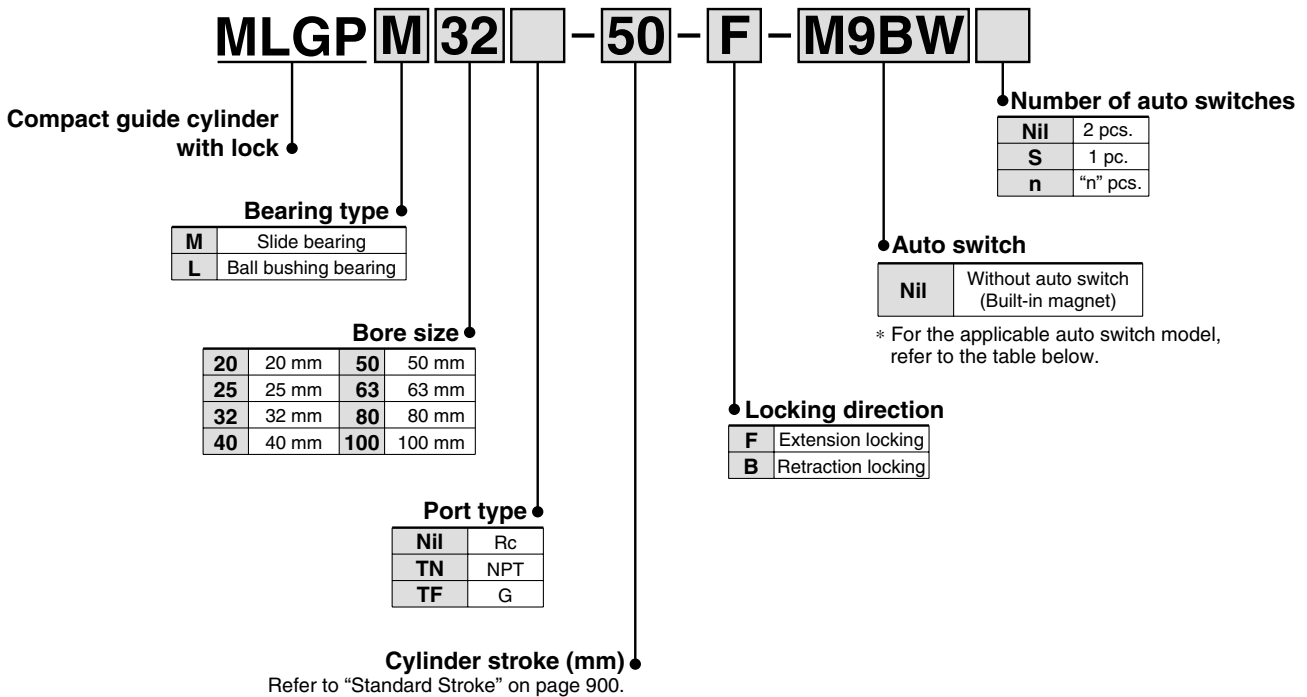

- CLJ2
- CLM2
- CLG1
- CL1
- MLGC
- CNG
- MNB
- CNA
- CNS
- CLS
- CLQ
- RLQ
- MLU
- MLGP
- ML1C

Applicable Auto Switch/Refer to pages 1719 to 1827 for further information on auto switches.

Type	Special function	Electrical entry	Indicator light	Wiring (Output)	Load voltage		Auto switch model		Lead wire length (m)				Pre-wired connector	Applicable load			
					DC	AC	Perpendicular	In-line	0.5 (Nil)	1 (M)	3 (L)	5 (Z)					
Solid state switch	—	Grommet	Yes	3-wire (NPN)	24 V	5 V, 12 V	—	M9NV	M9N	●	●	●	○	○	IC circuit	Relay, PLC	
				3-wire (PNP)				M9PV	M9P	●	●	●	○	○			
				2-wire				M9BV	M9B	●	●	●	○	○			
				3-wire (NPN)				M9NWV	M9NW	●	●	●	○	○			
	Diagnostic indication (2-color indication)			3-wire (PNP)	M9PWV	M9PW	●	●	●	○	○	○	○	IC circuit			
				2-wire	M9BWV	M9BW	●	●	●	○	○	○	—				
	Water resistant (2-color indication)			3-wire (NPN)	M9NAV	M9NA	○	○	●	○	○	○	○	IC circuit			
				3-wire (PNP)	M9PAV	M9PA	○	○	●	○	○	○	○	circuit			
Magnetic field resistant (2-color indication)	2-wire	M9BAV	M9BA	○	○	●	○	○	○	○	—						
	2-wire (Non-polar)	—	P4DW	—	—	●	●	○	○	○	—						
Reed switch	—	Grommet	Yes	3-wire (NPN equivalent)	—	5 V	—	A96V	A96	●	—	●	—	—	IC circuit	—	
				2-wire	24 V	12 V	100V	A93V	A93	●	—	●	—	—	—	—	Relay, PLC
							100V or less	A90V	A90	●	—	●	—	—	—	—	IC circuit

- * Lead wire length symbols: 0.5 m Nil (Example) M9NV
- 1 m M (Example) M9NM
- 3 m L (Example) M9NL
- 5 m Z (Example) M9NZ
- * Solid state auto switches marked with "○" are produced upon receipt of order.
- * D-P4DW can be mounted on the bore sizes ø32 to ø100.
- * Only D-P4DW is assembled at the time of shipment.

- * Since there are other applicable auto switches than listed, refer to page 908 for details.
- * For details about auto switches with pre-wired connector, refer to pages 1784 and 1785.
- * Auto switches are shipped together (not assembled). (Except D-P4DW)

- D-□
- X□
- Individual -X□

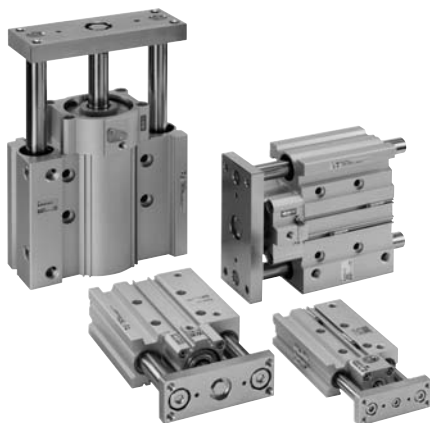

JIS Symbol

Extension locking

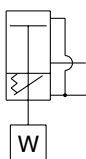

Retraction locking

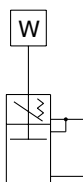

Cylinder Specifications

Bore size (mm)	20	25	32	40	50	63	80	100
Action	Double acting							
Fluid	Air							
Proof pressure	1.5 MPa							
Maximum operating pressure	1.0 MPa							
Minimum operating pressure	0.2 MPa ^{Note)}							
Ambient and fluid temperature	-10 to 60°C (No freezing)							
Piston speed	50 to 400 mm/s							
Cushion	Rubber bumper on both ends							
Lubrication	Not required							
Stroke length tolerance	$^{+1.5}_0$ mm							
Port size (Rc, NPT, G)	1/8		1/4			3/8		

Note) When the unlocking air and cylinder operating air are not common, the minimum operating pressure is 0.15 MPa. (The minimum operating pressure for the cylinder alone is 0.15 MPa.)

Lock Specifications

Bore size (mm)	20	25	32	40	50	63	80	100
Lock operation	Spring locking (Exhaust locking)							
Unlocking pressure	0.2 MPa or more							
Lock starting pressure	0.05 MPa or less							
Locking direction	One direction (Extension locking, Retraction locking)							
Maximum operating pressure	1.0 MPa							
Unlocking port size (Rc, NPT, G)	M5 x 0.8		1/8			1/4		
Holding force (Maximum static load) (N) ^{Note)}	157	245	402	629	982	1559	2513	3927

Note) Be sure to make cylinder selections in accordance with the method given on page 884.

Standard Stroke

Bore size (mm)	Standard stroke (mm)
20, 25	20, 30, 40, 50, 75, 100, 125, 150, 175, 200, 250, 300, 350
32 to 80	25, 50, 75, 100, 125, 150, 175, 200, 250, 300, 350
100	50, 75, 100, 125, 150, 175, 200, 250, 300, 350

Manufacture of Intermediate Stroke

Description	Spacer installation type Spacers are installed in the standard stroke cylinders. ø20 to 32: Stroke can be modified by the 1 mm interval. ø40 to 100: Stroke can be modified by the 5 mm interval.	
Part no.	Refer to "How to Order" for the standard model numbers.	
Applicable stroke (mm)	ø20, ø25, ø32	1 to 349
	ø40 to ø80	5 to 345
	ø100	25 to 345
Example	Part no.: MLGPM20-39-F A 1 mm spacer is installed in MLGPM20-40-F. Dimension C is 77 mm.	

Theoretical Output



Refer to pages 907 to 908 for cylinders with auto switches.

- Minimum auto switch mounting stroke
- Proper auto switch mounting position (detection at stroke end) and mounting height
- Operating range
- Switch mounting bracket: Part no.

Bore size (mm)	Rod size (mm)	Operating direction	Piston area (mm ²)	Operating pressure (MPa)								
				0.2	0.3	0.4	0.5	0.6	0.7	0.8	0.9	1.0
20	10	OUT	314	63	94	126	157	188	220	251	283	314
		IN	236	47	71	94	118	142	165	189	212	236
25	12	OUT	491	98	147	196	246	295	344	393	442	491
		IN	378	76	113	151	189	227	265	302	340	378
32	16	OUT	804	161	241	322	402	482	563	643	724	804
		IN	603	121	181	241	302	362	422	482	543	603
40	16	OUT	1257	251	377	503	629	754	880	1006	1131	1257
		IN	1056	211	317	422	528	634	739	845	950	1056
50	20	OUT	1963	393	589	785	982	1178	1374	1570	1767	1963
		IN	1649	330	495	660	825	990	1154	1319	1484	1649
63	20	OUT	3117	623	935	1247	1559	1870	2182	2494	2805	3117
		IN	2803	561	841	1121	1402	1682	1962	2242	2523	2803
80	25	OUT	5027	1005	1508	2011	2514	3016	3519	4022	4524	5027
		IN	4536	907	1361	1814	2268	2722	3175	3629	4082	4536
100	30	OUT	7854	1571	2356	3142	3927	4712	5498	6283	7069	7854
		IN	7147	1429	2144	2859	3574	4288	5003	5718	6432	7147

Note) Theoretical output (N) = Pressure (MPa) x Piston area (mm²)

Mass

Slide Bearing: MLGPM20 to 100

Bore size (mm)	Standard stroke (mm)														(kg)
	20	25	30	40	50	75	100	125	150	175	200	250	300	350	
20	0.84	—	0.92	1.00	1.08	1.34	1.54	1.74	1.93	2.13	2.33	2.80	3.20	3.59	
25	1.22	—	1.32	1.43	1.54	1.92	2.19	2.46	2.74	3.01	3.28	3.94	4.48	5.03	
32	—	2.09	—	—	2.47	2.87	3.25	3.64	4.02	4.40	4.78	5.73	6.49	7.26	
40	—	2.44	—	—	2.86	3.32	3.74	4.17	4.59	5.02	5.44	6.48	7.34	8.19	
50	—	4.13	—	—	4.77	5.50	6.14	6.78	7.42	8.06	8.70	10.4	11.6	12.9	
63	—	5.23	—	—	5.99	6.83	7.59	8.34	9.10	9.85	10.7	12.5	14.0	15.5	
80	—	8.50	—	—	9.44	10.7	11.7	12.6	13.6	14.5	15.5	17.9	19.8	21.6	
100	—	—	—	—	15.3	17.0	18.3	19.7	21.0	22.3	23.6	27.0	29.6	32.3	

Ball Bushing Bearing: MLGPL20 to 100

Bore size (mm)	Standard stroke (mm)														(kg)
	20	25	30	40	50	75	100	125	150	175	200	250	300	350	
20	0.86	—	0.93	1.05	1.13	1.30	1.47	1.68	1.85	2.03	2.20	2.58	2.93	3.28	
25	1.22	—	1.31	1.49	1.58	1.81	2.05	2.32	2.55	2.78	3.01	3.51	3.98	4.44	
32	—	1.89	—	—	2.20	2.65	2.97	3.34	3.66	3.97	4.29	4.98	5.61	6.24	
40	—	2.16	—	—	2.58	3.07	3.43	3.85	4.21	4.57	4.93	5.71	6.43	7.15	
50	—	3.69	—	—	4.33	5.08	5.63	6.27	6.82	7.37	7.92	9.15	10.3	11.4	
63	—	4.77	—	—	5.53	6.40	7.06	7.82	8.48	9.15	9.81	11.3	12.7	14.0	
80	—	8.11	—	—	9.25	10.6	11.4	12.2	13.0	13.9	14.7	16.6	18.2	19.9	
100	—	—	—	—	14.7	16.5	17.6	18.8	20.0	21.2	22.4	25.0	27.3	29.7	

Allowable Rotational Torque of Plate

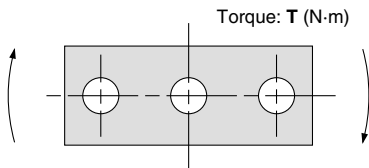

Non-rotating Accuracy of Plate

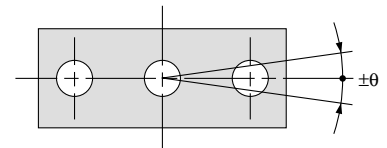

Note) For non-rotating accuracy θ without load, use a value no more than the values in the table as a guide.

T (N-m)

Bore size (mm)	Bearing type	Stroke													
		20	25	30	40	50	75	100	125	150	175	200	250	300	350
20	MLGPM	0.77	—	0.70	0.64	0.59	1.62	1.42	1.27	1.15	1.05	0.97	0.83	0.73	0.65
	MLGPL	0.75	—	0.68	1.49	1.41	1.24	1.11	1.29	1.18	1.08	1.00	0.86	0.76	0.67
25	MLGPM	1.24	—	1.13	1.04	0.97	2.49	2.20	1.98	1.79	1.64	1.51	1.30	1.15	1.02
	MLGPL	1.23	—	1.14	2.26	2.14	1.90	1.71	1.96	1.79	1.65	1.53	1.33	1.17	1.04
32	MLGPM	—	4.89	—	—	4.13	4.82	4.29	3.87	3.53	3.24	2.99	2.60	2.30	2.06
	MLGPL	—	4.22	—	—	3.64	4.07	3.67	5.37	4.97	4.62	4.31	3.80	3.39	3.06
40	MLGPM	—	5.29	—	—	4.49	5.25	4.68	4.23	3.86	3.54	3.28	2.85	2.52	2.26
	MLGPL	—	4.53	—	—	3.93	4.41	3.98	5.84	5.41	5.03	4.70	4.15	3.70	3.34
50	MLGPM	—	10.06	—	—	8.66	10.13	9.12	8.29	7.60	7.01	6.51	5.70	5.06	4.56
	MLGPL	—	6.40	—	—	5.57	7.76	7.04	9.75	9.05	8.43	7.88	6.96	6.22	5.60
63	MLGPM	—	11.13	—	—	9.60	11.27	10.15	9.24	8.48	7.83	7.28	6.37	5.67	5.11
	MLGPL	—	6.91	—	—	6.02	8.48	7.69	10.73	9.95	9.27	8.67	7.65	6.83	6.14
80	MLGPM	—	16.70	—	—	14.67	19.10	17.41	15.99	14.79	13.75	12.85	11.36	10.18	9.23
	MLGPL	—	9.44	—	—	16.88	17.92	16.51	15.28	14.20	13.24	12.37	10.89	9.66	8.62
100	MLGPM	—	—	—	—	26.17	30.70	28.23	26.12	24.31	22.73	21.35	19.03	17.17	15.64
	MLGPL	—	—	—	—	21.11	29.10	26.98	25.10	23.43	21.93	20.57	18.21	16.22	14.53

Bore size (mm)	Non-rotating accuracy θ	
	MLGPM	MLGPL
20	$\pm 0.07^\circ$	$\pm 0.09^\circ$
25	$\pm 0.07^\circ$	$\pm 0.09^\circ$
32	$\pm 0.06^\circ$	$\pm 0.08^\circ$
40	$\pm 0.06^\circ$	$\pm 0.08^\circ$
50	$\pm 0.05^\circ$	$\pm 0.06^\circ$
63	$\pm 0.05^\circ$	$\pm 0.06^\circ$
80	$\pm 0.04^\circ$	$\pm 0.05^\circ$
100	$\pm 0.04^\circ$	$\pm 0.05^\circ$

Note) Do not apply rotational force in a locked condition, as this will cause damage to the lock mechanism or decrease of the product life.

CLJ2

CLM2

CLG1

CL1

MLGC

CNG

MNB

CNA

CNS

CLS

CLQ

RLQ

MLU

MLGP

ML1C

D-□

-X□

Individual
-X□

Series MLGP

Construction: $\phi 20$, $\phi 25$, $\phi 32$

Series MLGPM

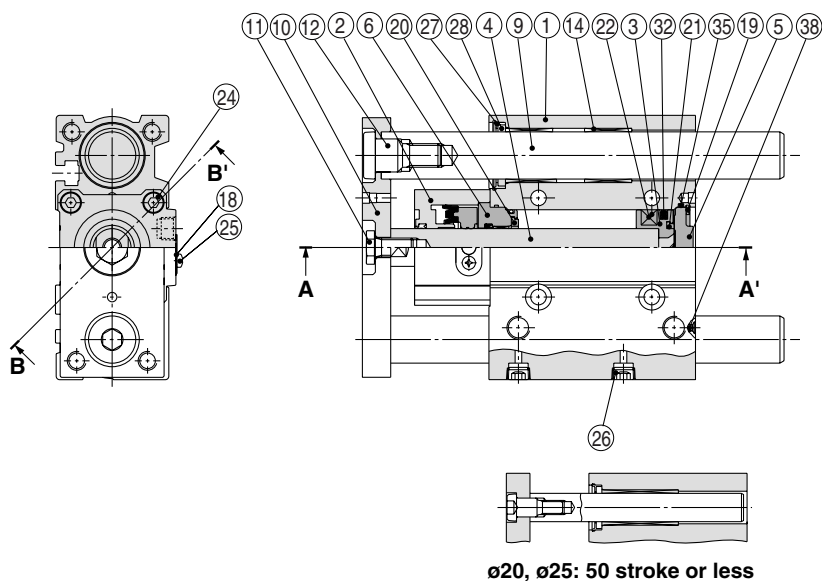

Series MLGPL

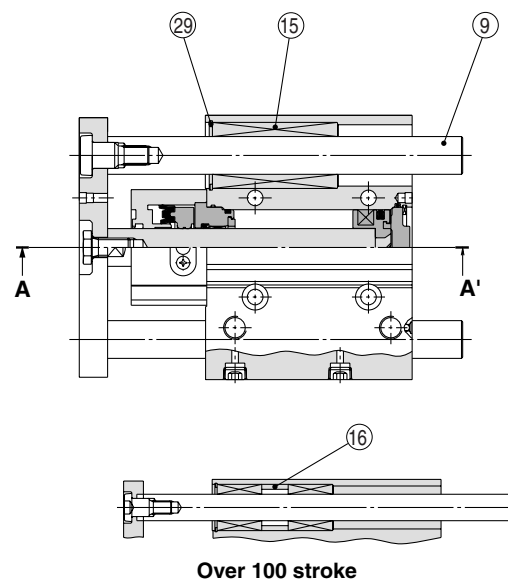

Type F (Extension locking)

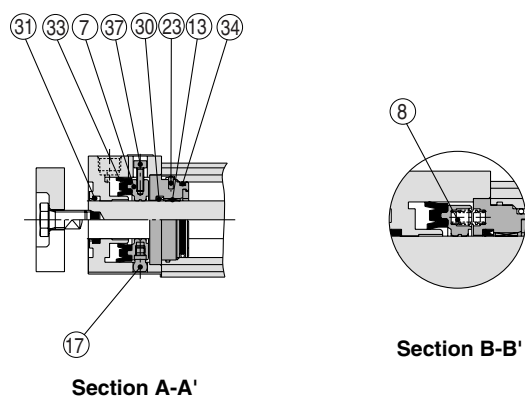

Type B (Retraction locking)

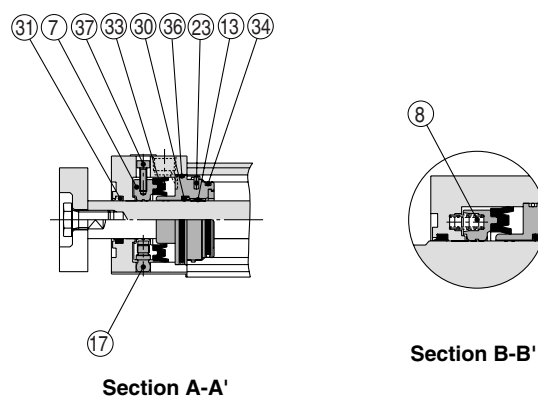

* Above figures show the unlocked state.

Component Parts

No.	Description	Material	Note
1	Body	Aluminum alloy	Hard anodized
2	Lock body	Aluminum alloy	Hard anodized
3	Piston	Aluminum alloy	Chromated
4	Piston rod	$\phi 20, 25$: Stainless steel $\phi 32$: Carbon steel	Hard chrome plated
5	Head cover	Aluminum alloy	Chromated
6	Intermediate collar	Aluminum alloy	Chromated
7	Lock ring	Carbon steel	Heat treated
8	Brake spring	Steel wire	Zinc chromated
9	Guide rod	Type M: Carbon steel Type L: High carbon chrome bearing steel	Hard chromium electroplated
10	Plate	Rolled steel	Nickel plated
11	Plate mounting bolt	Chromium molybdenum steel	Nickel plated
12	Guide bolt	Chromium molybdenum steel	Nickel plated
13	Bushing	$\phi 20, 25$: Oil-impregnated sintered alloy $\phi 32$: Copper alloy	
14	Bushing	Copper alloy	Type MLGPM
15	Ball bushing	—	Type MLGPL
16	Spacer	Aluminum alloy	Chromated (Type MLGPL only)
17	Pivot	Chromium molybdenum steel	Heat treated/Hard chrome plated
18	Dust cover	Stainless steel	

Component Parts

No.	Description	Material	Note
19	Type C retaining ring for hole	Carbon tool steel	Phosphate coated
20	Bumper A	Urethane	
21	Bumper B	Urethane	
22	Magnet	—	
23	Parallel pin	Stainless steel	
24	Hexagon socket head cap screw	Chromium molybdenum steel	Nickel plated
25	Dust cover holding bolt	Carbon steel	Nickel plated
26	Hexagon socket head plug	Carbon steel	Nickel plated
27	Holder	Resin	Type MLGPM only
28	Felt	Felt	Type MLGPM only
29	Type C retaining ring for hole	Carbon tool steel	Phosphate coated (Type MLGPL only)
30	Rod seal	NBR	
31	Scraper	NBR	
32	Piston seal	NBR	
33	Lock ring seal	NBR	
34	Gasket A	NBR	
35	Gasket B	NBR	
36	Lock body gasket	NBR	
37	Unlocking bolt	Chromium molybdenum steel	Nickel plated
38	Steel ball	High carbon chrome bearing steel	

Construction: $\phi 40$ to $\phi 100$

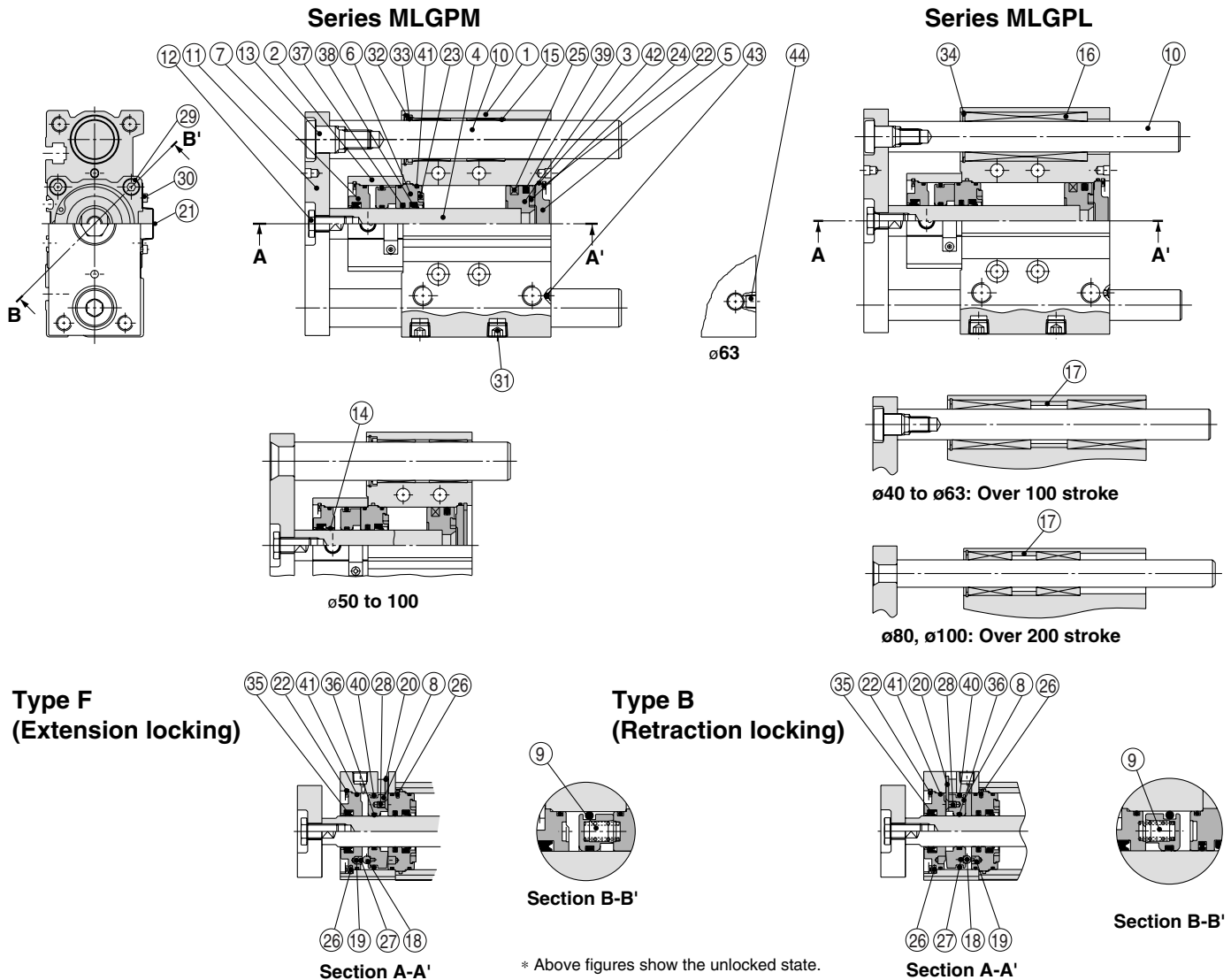

- CLJ2
- CLM2
- CLG1
- CL1
- MLGC
- CNG
- MNB
- CNA
- CNS
- CLS
- CLQ
- RLQ
- MLU
- MLGP**
- ML1C

Component Parts

No.	Description	Material	Note
1	Body	Aluminum alloy	Hard anodized
2	Lock body	Aluminum alloy	Hard anodized
3	Piston	Aluminum alloy	Chromated
4	Piston rod	Carbon steel	Hard chrome plated
5	Head cover	$\phi 40$ to $\phi 63$	Aluminum alloy
		$\phi 80, 100$	Aluminum alloy casted
6	Intermediate collar	Aluminum alloy	Chromated
7	Collar	$\phi 40$	Aluminum alloy
		$\phi 50$ to 100	Aluminum alloy casted
8	Lock ring	Carbon steel	Heat treated
9	Brake spring	Steel wire	Zinc chromated
10	Guide rod	Type M	Carbon steel
		Type L	High carbon chrome bearing steel
11	Plate	Rolled steel	Nickel plated
12	Plate mounting bolt	Chromium molybdenum steel	Nickel plated
13	Guide bolt	Chromium molybdenum steel	$\phi 40$, Nickel plated
14	Bushing	Copper alloy	$\phi 50$ to 100
15	Bushing	Copper alloy	Type MLGPM
16	Ball bushing	—	Type MLGPL
17	Spacer	Aluminum alloy	Chromated (Type MLGPL only)
18	Pivot pin	Carbon steel	Heat treated/Zinc chromated
19	Pivot key	Carbon steel	Heat treated/Zinc chromated
20	Lever	Stainless steel	
21	Dust cover	$\phi 40$ to $\phi 63$	Rolled steel
		$\phi 80, 100$	Stainless steel

Component Parts

No.	Description	Material	Note
22	Type C retaining ring for hole	Carbon tool steel	Phosphate coated
23	Bumper A	Urethane	
24	Bumper B	Urethane	
25	Magnet	—	
26	Parallel pin	Stainless steel	
27	Spring pin	Carbon steel	
28	Hexagon socket countersunk head screw	Chromium molybdenum steel	Nickel plated
29	Hexagon socket head cap screw	Chromium molybdenum steel	Nickel plated
30	Dust cover holding bolt	$\phi 40$ to $\phi 63$	Chromium molybdenum steel
		$\phi 80, 100$	Carbon steel
31	Hexagon socket head plug	Carbon steel	Nickel plated
32	Holder	Resin	Type MLGPM only
33	Felt	Felt	Type MLGPM only
34	Type C retaining ring for hole	Carbon tool steel	Phosphate coated (Type MLGPL only)
35	Rod seal A	NBR	
36	Rod seal B	NBR	
37	Rod seal C	NBR	
38	Scraper	NBR	
39	Piston seal	NBR	
40	Brake piston seal	NBR	
41	Gasket A	NBR	
42	Gasket B	NBR	
43	Steel ball	High carbon chrome bearing steel	$\phi 40, \phi 50$
44	Plug	Carbon steel	$\phi 63$ to 100 , Nickel plated

- D-
- X
- Individual -X

Series MLGP

Dimensions: $\phi 20$, $\phi 25$, $\phi 32$

MLGPM/MLGPL

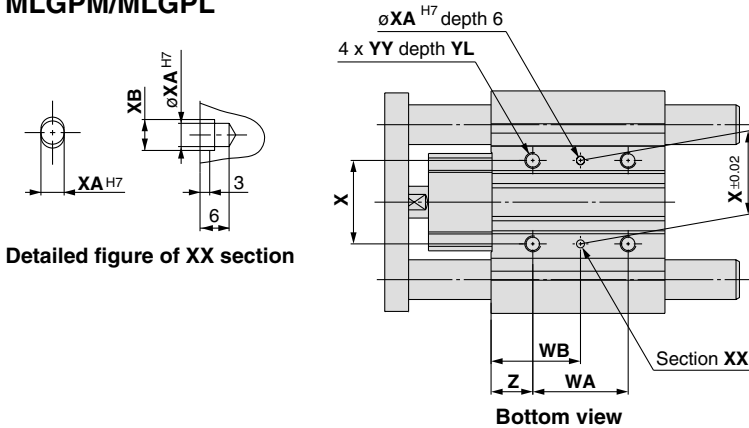

Detailed figure of XX section

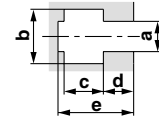

T-slot dimensions

Bore size (mm)	a	b	c	d	e
20	5.4	8.4	4.5	2.8	7.8
25	5.4	8.4	4.5	3	8.2
32	6.5	10.5	5.5	3.5	9.5

Extension locking



Retraction locking

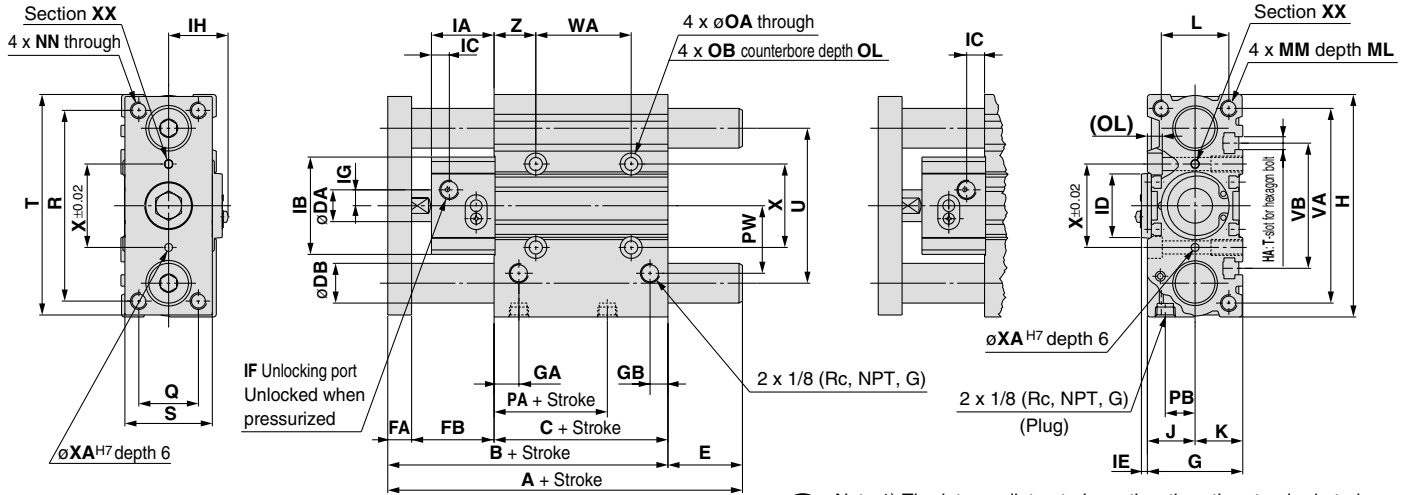

Note 1) The intermediate strokes other than the standard strokes at left are manufactured by means of installing a spacer. Intermediate strokes for $\phi 20$ to $\phi 32$ are available by the 1 mm interval.

Note 2) For intermediate strokes, dimensions A, B, C, E, PA, WA, and WB will be the same as the standard stroke with a longer one. (mm)

Common Dimensions: MLGPM/MLGPL

Bore size (mm)	Standard stroke (mm)	B	C	DA	FA	FB	G	GA	GB	H	HA	IA	IB	IC				ID	IE	IF					
														Extension locking		Retraction locking				Rc, NPT	G	Rc, NPT	G	Rc, NPT	G
														Rc, NPT	G	Rc, NPT	G								
20	20, 30, 40, 50, 75, 100, 125	79.5	37	10	10	32.5	36	10.5	8.5	83	M5	26.5	36	9.5	9.5	6	6	—	—	M5 x 0.8	M5 x 0.8				
25	150, 175, 200, 250, 300, 350	84	37.5	12	10	36.5	42	11.5	9	93	M5	30.5	40	10	10	7.5	7.5	—	—	M5 x 0.8	M5 x 0.8				
32	25, 50, 75, 100, 125, 150, 175, 200, 250, 300, 350	91	37.5	16	12	41.5	48	12.5	9	112	M6	31.5	49	9	8	9	4	32	3	1/8	M5 x 0.8				

Bore size (mm)	IG	IH	J	K	L	MM	ML	NN	OA	OB	OL	PA	PB	PW	Q	R	S	T	U	VA	VB
20	6.5	21.2	18	18	24	M5 x 0.8	13	M5 x 0.8	5.4	9.5	5.5	12.5	10.5	25	18	70	30	81	54	72	44
25	7	23.2	21	21	30	M6 x 1.0	15	M6 x 1.0	5.4	9.5	5.5	12.5	13.5	30	26	78	38	91	64	82	50
32	8	30.2	24	24	34	M8 x 1.25	20	M8 x 1.25	6.6	11	7.5	7	15	35.5	30	96	44	110	78	98	63

Bore size (mm)	WA						WB						X	XA	XB	YY	YL	Z		
	st \leq 25	st \leq 30	25 < st \leq 100	30 < st \leq 100	100 < st \leq 200	200 < st \leq 300	300 < st \leq 350	st \leq 25	st \leq 30	25 < st \leq 100	30 < st \leq 100	100 < st \leq 200							200 < st \leq 300	300 < st \leq 350
20	—	24	—	44	120	200	300	—	29	—	39	77	117	167	28	3	3.5	M6 x 1.0	12	17
25	—	24	—	44	120	200	300	—	29	—	39	77	117	167	34	4	4.5	M6 x 1.0	12	17
32	24	—	48	—	124	200	300	33	—	45	—	83	121	171	42	4	4.5	M8 x 1.25	16	21

A, DB, E Dimensions: MLGPM (Slide bearing) (mm)

Bore size (mm)	A			DB	E		
	st \leq 50	50 < st \leq 200	200 < st		st \leq 50	50 < st \leq 200	200 < st
20	79.5	111	148.5	12	0	31.5	69
25	84	115.5	152.5	16	0	31.5	68.5
32	128.5	133.5	171.5	20	37.5	42.5	80.5

A, DB, E Dimensions: MLGPL (Ball bushing bearing) (mm)

Bore size (mm)	A						DB	E					
	st \leq 30	st \leq 50	30 < st \leq 100	50 < st \leq 100	100 < st \leq 200	200 < st \leq 350		st \leq 30	st \leq 50	30 < st \leq 100	50 < st \leq 100	100 < st \leq 200	200 < st \leq 350
20	89.5	—	106.5	—	130.5	148.5	10	10	—	27	—	51	69
25	100	—	116	—	135	152.5	13	16	—	32	—	51	68.5
32	—	112.5	—	129.5	149.5	171.5	16	—	21.5	—	38.5	58.5	80.5

Dimensions: $\phi 40$, $\phi 50$, $\phi 63$

MLGPM/MLGPL

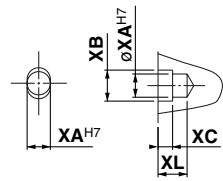

Detailed figure of XX section

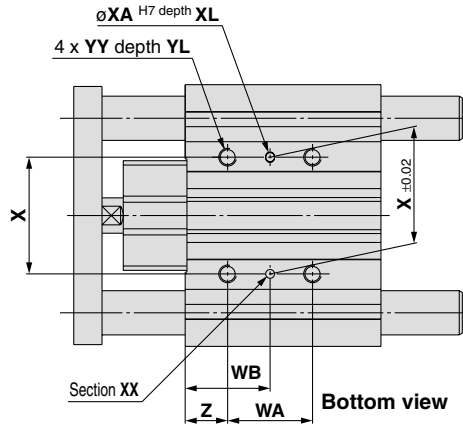

Bottom view

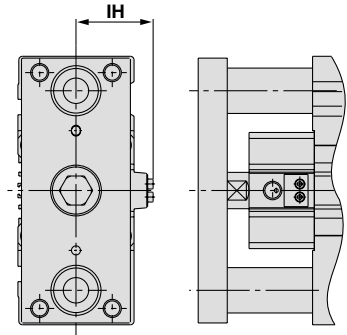

$\phi 40$

Extension locking



Retraction locking

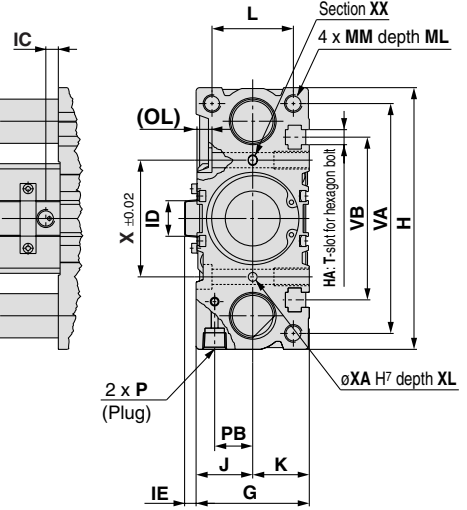
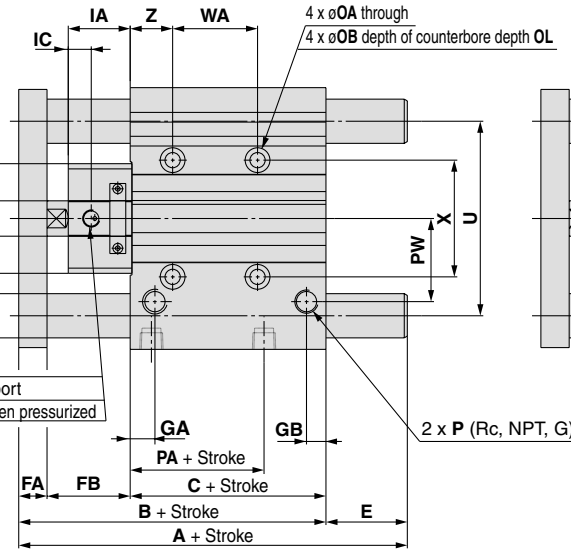
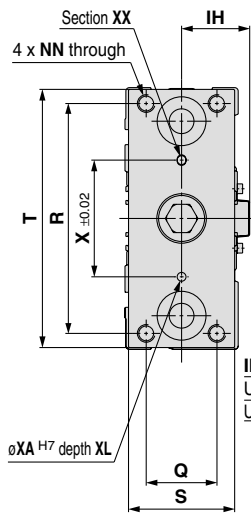

Note 1) The intermediate strokes other than the standard strokes at left are manufactured by means of installing a spacer.
Intermediate strokes for $\phi 40$ to $\phi 63$ are available by the 5 mm interval.
Note 2) For intermediate strokes, dimensions A, B, C, E, PA, WA, and WB will be the same as the standard stroke with a longer one.

T-slot dimensions

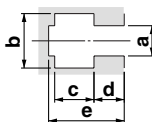

Bore size (mm)	a	b	c	d	e
40	6.5	10.5	5.5	4	11
50	8.5	13.5	7.5	4.5	13.5
63	11	17.8	10	7	18.5

Common Dimensions: MLGPM/MLGPL

Bore size (mm)	Standard stroke (mm)	B	C	DA	FA	FB	G	GA	GB	H	HA	IA	IB	IC				ID	IE	IF	
														Extension locking Rc, NPT G	Retraction locking Rc, NPT G					Rc, NPT	G
40	25, 50, 75, 100, 125, 150 175, 200, 250, 300, 350	100	44	16	12	44	54	14	10	120	M6	34	52	11	13.8	6.5	4.5	14	4	1/8	M5 x 0.8
50		107	44	20	16	47	64	14	11	148	M8	35	62	13	15	6.8	4.8	19	6.5	1/8	M5 x 0.8
63		115	49	20	16	50	78	16.5	13.5	162	M10	38	79	16.5	16.2	7.5	6.5	19	6.5	1/8	1/8

Bore size (mm)	IH	J	K	L	MM	ML	NN	OA	OB	OL	P	PA	PB	PW	Q	R	S	T	U	VA	VB
40	34.5	27	27	40	M8 x 1.25	20	M8 x 1.25	6.6	11	7.5	1/8	13	18	39.5	30	104	44	118	86	106	72
50	38.5	32	32	46	M10 x 1.5	22	M10 x 1.5	8.6	14	9	1/4	9	21.5	47	40	130	60	146	110	130	92
63	46	39	39	58	M10 x 1.5	22	M10 x 1.5	8.6	14	9	1/4	14	28	58	50	130	70	158	124	142	110

Bore size (mm)	WA					WB					X	XA	XB	XC	XL	YY	YL	Z
	st ≤ 25	25 < st ≤ 100	100 < st ≤ 200	200 < st ≤ 300	300 < st ≤ 350	st ≤ 25	25 < st ≤ 100	100 < st ≤ 200	200 < st ≤ 300	300 < st ≤ 350								
40	24	48	124	200	300	34	46	84	122	172	50	4	4.5	3	6	M8 x 1.25	16	22
50	24	48	124	200	300	36	48	86	124	174	66	5	6	4	8	M10 x 1.5	20	24
63	28	52	128	200	300	38	50	88	124	174	80	5	6	4	8	M10 x 1.5	20	24

Dimensions A, DB, E: MLGPM (Slide bearing) (mm)

Bore size (mm)	A			DB	E		
	st ≤ 50	50 < st ≤ 200	200 < st ≤ 350		st ≤ 50	50 < st ≤ 200	200 < st ≤ 350
40	131	136	174	20	31	36	74
50	141.5	153	196	25	34.5	46	89
63	144.5	156	199	25	29.5	41	84

Dimensions A, DB, E: MLGPL (Ball bushing bearing) (mm)

Bore size (mm)	A				DB	E			
	st ≤ 50	50 < st ≤ 100	100 < st ≤ 200	200 < st ≤ 350		st ≤ 50	50 < st ≤ 100	100 < st ≤ 200	200 < st ≤ 350
40	115	132	152	174	16	15	32	52	74
50	128	149	169	196	20	21	42	62	89
63	131	152	172	199	20	16	37	57	84

CLJ2

CLM2

CLG1

CL1

MLGC

CNG

MNB

CNA

CNS

CLS

CLQ

RLQ

MLU

MLGP

ML1C

D-□

-X□

Individual

-X□

Series MLGP

Dimensions: $\phi 80, \phi 100$

MLGPM/MLGPL

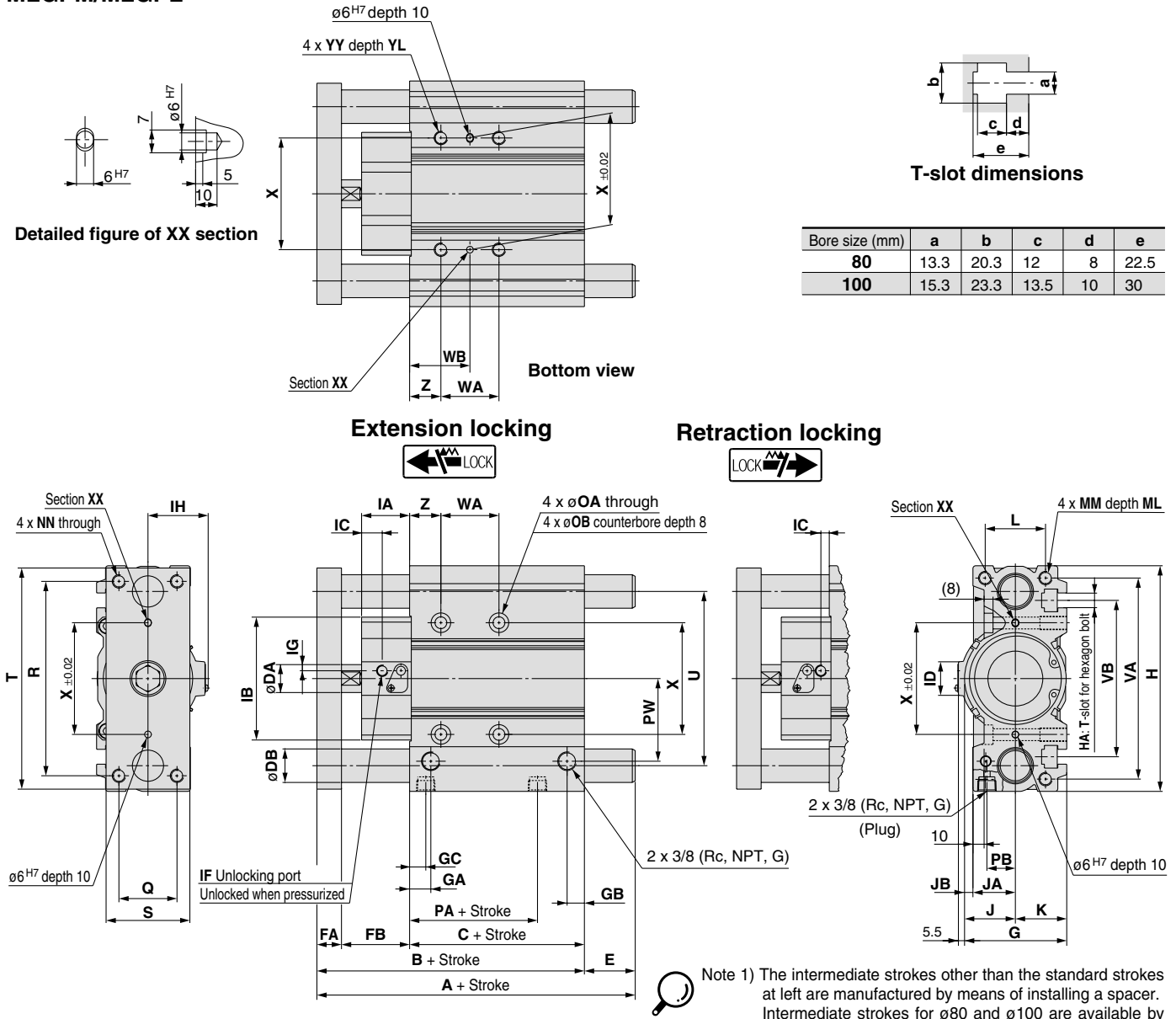

Note 1) The intermediate strokes other than the standard strokes at left are manufactured by means of installing a spacer. Intermediate strokes for $\phi 80$ and $\phi 100$ are available by the 5 mm interval.

Note 2) For intermediate strokes, dimensions A, B, C, E, PA, WA, and WB will be the same as the standard stroke with a longer one.

Common Dimensions: MLGPM/MLGPL

Bore size (mm)	Standard stroke (mm)	B	C	DA	FA	FB	G	GA	GB	GC	H	HA	IA	IB	IC				IF			
															Extension locking		Retraction locking		ID	IE	RC,NPT	G
															RC,NPT	G	RC,NPT	G				
80	25, 50, 75, 100, 125, 150, 175, 200, 250, 300, 350	139.5	56.5	25	22	61	91.5	19	15.5	14.5	202	M12	43	110	18.5	18.5	6.5	6.5	30	5.5	1/8	1/8
100	50, 75, 100, 125, 150, 175, 200, 250, 300, 350	167.5	66	30	25	76.5	111.5	23	19	18	240	M14	51.5	137	23	23	11	7	50	5.5	1/4	1/8

Bore size (mm)	IG	IH	J	JA	JB	K	L	MM	ML	NN	OA	OB	PA	PB	PW	Q	R	S	T	U	VA	VB
80	7	54.2	45.5	38	7.5	46	54	M12 x 1.75	25	M12 x 1.75	10.6	17.5	14.5	25.5	74	52	174	75	198	156	180	140
100	15	64.2	55.5	45	10.5	56	62	M14 x 2.0	31	M14 x 2.0	12.5	20	17.5	32.5	89	64	210	90	236	188	210	166

Bore size (mm)	WA						WB						X	YY	YL	Z		
	st ≤ 25	st ≤ 50	25 < st ≤ 100	50 < st ≤ 100	100 < st ≤ 200	200 < st ≤ 300	300 < st ≤ 350	st ≤ 25	st ≤ 50	25 < st ≤ 100	50 < st ≤ 100	100 < st ≤ 200					200 < st ≤ 300	300 < st ≤ 350
	80	28	—	52	—	128	200	300	42	—	54	—					92	128
100	—	50	—	72	124	200	300	—	60	—	71	97	135	185	124	M14 x 2.0	28	35

Dimensions A, DB, E: MLGPM (Slide bearing) (mm)

Bore size (mm)	A			DB	E		
	st ≤ 50	50 < st ≤ 200	200 < st ≤ 350		st ≤ 50	50 < st ≤ 200	200 < st ≤ 350
	80	158	185		236	30	18.5
100	188.5	213.5	254.5	36	21	46	87

Dimensions A, DB, E: MLGPL (Ball bushing bearing) (mm)

Bore size (mm)	A				DB	E			
	st ≤ 25	25 < st ≤ 50	50 < st ≤ 200	200 < st ≤ 350		st ≤ 25	25 < st ≤ 50	50 < st ≤ 200	200 < st ≤ 350
	80	152.5	173	203		236	25	13	33.5
100	—	198.5	231.5	254.5	30	—	31	64	87

Auto Switch Proper Mounting Position (Detection at Stroke End) and Its Mounting Height

- | | |
|----------|---------|
| D-A9□ | D-Z7□ |
| D-A9□V | D-Z80 |
| D-M9□ | D-Y59□ |
| D-M9□V | D-Y69□ |
| D-M9□W | D-Y7P |
| D-M9□WV | D-Y7PV |
| D-M9□AL | D-Y7□W |
| D-M9□AVL | D-Y7□WV |
| | D-Y7BA |

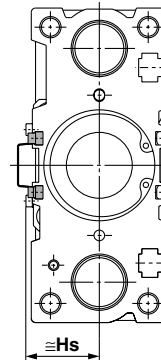
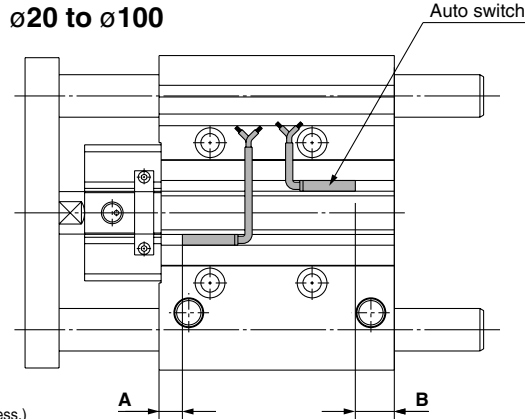

$\phi 80, \phi 100$

D-P5DWL (* Cannot be mounted on bore size $\phi 25$ or less.)
 $\phi 32 \text{ to } \phi 63$

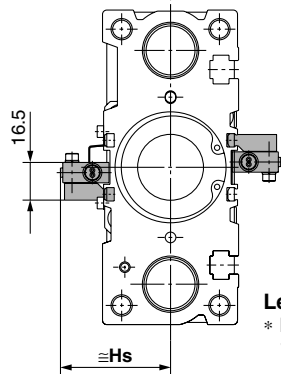
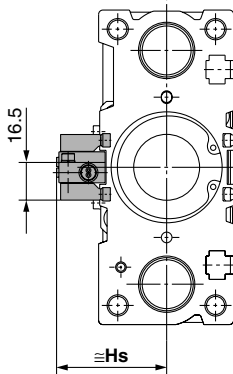

Less than 25 to 75 strokes
 * For bore sizes $\phi 32$ through $\phi 63$ with two switches, one switch is mounted on each side.

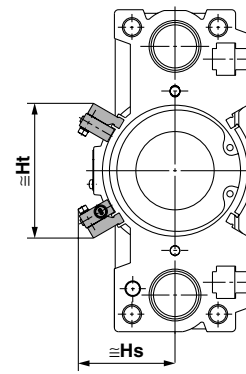

Auto Switch Proper Mounting Position (mm)

Auto switch model \ Bore size (mm)	D-M9□ D-M9□V D-M9□W D-M9□WV D-M9□AL D-M9□AVL		D-A9□ D-A9□V		D-Z7□/Z80 D-Y59□/Y7P D-Y69□/Y7PV D-Y7□W D-Y7□WV D-Y7BAL		D-P4DWL	
	A	B	A	B	A	B	A	B
20	9.5	12.5	5.5	8.5	4.5	7.5	—	—
25	9.5	13	5.5	9	4.5	8	—	—
32	10.5	12	6.5	8	5.5	7	5	6.5
40	14.5	14.5	10.5	10.5	9.5	9.5	9	9
50	12.5	16.5	8.5	12.5	7.5	11.5	7	11
63	15	19	11	15	10	14	9.5	13.5
80	18	23.5	14	19.5	13	18.5	12.5	18
100	22.5	28.5	18.5	24.5	17.5	23.5	17	23

Note) Adjust the auto switch after confirming the operating conditions in the actual setting.

Auto Switch Mounting Height (mm)

Auto switch model \ Bore size (mm)	D-A9□/M9□ D-M9□W D-M9□AL D-Z7□/Z80 D-Y59□/Y7P D-Y7□W D-Y7BAL		D-A9□V		D-M9□V D-M9□WV D-M9□AVL		D-Y69□ D-Y7PV D-Y7□WV		D-P4DWL	
	Hs	Ht	Hs	Ht	Hs	Ht	Hs	Ht	Hs	Ht
20	18.5	22	—	—	24.5	—	20	—	—	—
25	20.5	24	—	—	26	—	21.5	—	—	—
32	23	26.5	—	—	29	—	24.5	—	41.5	—
40	27	30.5	—	—	33	—	28.5	—	44.5	—
50	32.5	36	—	—	38.5	—	34	—	50	—
63	39.5	43	—	—	45.5	—	41	—	57	—
80	40	43	71.5	—	45	74	41	70	61	84.5
100	50	53	83	—	55	85.5	51	81.5	71	96.5

- CLJ2
- CLM2
- CLG1
- CL1
- MLGC
- CNG
- MNB
- CNA
- CNS
- CLS
- CLQ
- RLQ
- MLU
- MLGP**
- ML1C

- D-□
- X□
- Individual -X□

Minimum Auto Switch Mounting Stroke

		(mm)								
Auto switch model	No. of auto switch mounted	ø20	ø25	ø32	ø40	ø50	ø63	ø80	ø100	
D-A9□	1 pc.					5				
	2 pcs.					10				
D-A9□V D-M9□V	1 pc.					5				
	2 pcs.					10				
D-M9□	1 pc.	10				5				
	2 pcs.					10				
D-M9□W	1 pc.					10				
	2 pcs.					10				
D-M9□WV D-M9□AVL	1 pc.					10				
	2 pcs.					10				
D-M9□AL	1 pc.					10				
	2 pcs.					15				
D-Z7□ D-Z80	1 pc.	10				5				
	2 pcs.					10				
D-Y59□ D-Y7P	1 pc.	10				5				
	2 pcs.					10				
D-Y69□ D-Y7PV	1 pc.					5				
	2 pcs.					5				
D-Y7□W D-Y7□WV	1 pc.					10				
	2 pcs.					15				
D-Y7BAL	1 pc.					10				
	2 pcs.					15				
D-P4DWL	1 pc.	—				10				
	2 pcs., Different surfaces	—				20				
	2 pcs., Same surface	—				75				

* D-P4DW can be mounted on the bore sizes ø32 to ø100.

Operating Range

Auto switch model	Bore size (mm)							
	20	25	32	40	50	63	80	100
D-A9□/A9□V	9	9	9	9.5	9.5	11	10.5	10.5
D-M9□/M9□V D-M9□W/M9□WV D-M9□AL/M9□AVL	5.5	5	6	5.5	6	6.5	6	7
D-Z7□/Z80	10	10	10.5	10.5	10.5	11.5	11.5	12
D-Y5□/Y6□ D-Y7P/Y7PV D-Y7□W/Y7□WV D-Y7BAL	7.5	7	6.5	6	7	8	9.5	10
D-P4DWL	—	—	5	4	4	5	4	4

* Since this is a guideline including hysteresis, not meant to be guaranteed. (Assuming approximately ±30% dispersion) There may be the case it will vary substantially depending on an ambient environment.

Auto Switch Mounting Bracket: Part No.

Auto switch model	Bore size (mm)	
	ø20 to ø32	ø40 to ø100
D-A9□/A9□V D-M9□/M9□V D-M9□W/M9□WV D-M9□AL/M9□AVL	BMG2-012	
D-P4DWL	—	BMG1-040

* D-A9□(V), M9□(V), M9□W(V), M9□A(V)L

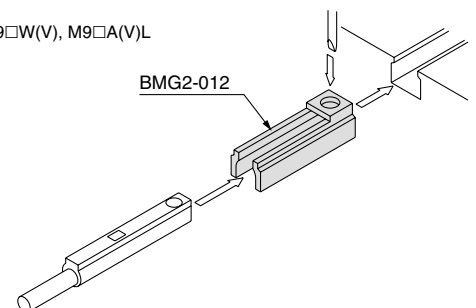

Other than the applicable auto switches listed in “How to Order”, the following auto switches can be mounted. For detailed specifications, refer to pages 1719 to 1827.

Auto switch model	Model	Electrical entry (Fetching direction)	Features
Reed	D-Z73, Z76	Grommet (In-line)	—
	D-Z80		Without indicator light
Solid state	D-Y69A, Y69B, Y7PV	Grommet (Perpendicular)	—
	D-Y7NWV, Y7PWV, Y7BWV		Diagnostic indication (2-color)
	D-Y59A, Y59B, Y7P	Grommet (In-line)	—
	D-Y7NW, Y7PW, Y7BW		Diagnostic indication (2-color indication)
	D-Y7BAL		Water resistant (2-color indication)
	D-P5DWL		Magnetic field resistant (2-color indication)

* For solid state auto switches, auto switches with a pre-wired connector are also available. Refer to pages 1784 and 1785.

* Normally closed (NC = b contact) solid state auto switches (D-F9G/F9H/Y7G/Y7H types) are also available. Refer to pages 1746 and 1748 for details.

Compact Guide Cylinder /Wide type

New

∅20, ∅25, ∅32, ∅40, ∅50, ∅63

Doubling the guide pitch

triple the allowable plate rotational torque.

1.84 lbf·ft ← **0.55 lbf·ft**
(**2.5 N·m** ← **0.75 N·m**)

For MGPWM20-50

- The allowable rotational torque of the plate is improved by up to 3 times by making the guide pitch twice the basic type and placing the guide components at an optimal location.
- Suitable when used as a pusher or lifter.

◆ Allowable rotational torque

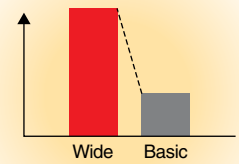
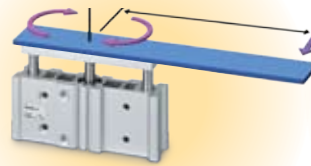

Non-rotating accuracy of the plate improved

±0.03° ← **±0.09°**

Wide type

For MGPWL20

Basic type

For MGPL20

- The plate non-rotating accuracy is improved due to the increase in guide pitch.

◆ Non-rotating accuracy

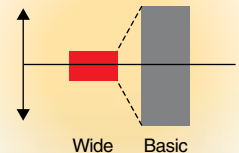
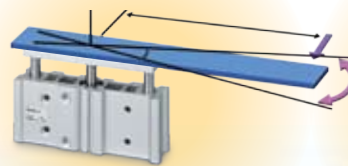

Equivalent weight to the basic type

- Although the volume is 170% more than the MGP basic type, the weight of the MGP wide type is equivalent to the basic type by changing the plate material and optimizing the component dimensions.

New MGPWM

Equivalent weight

Basic type

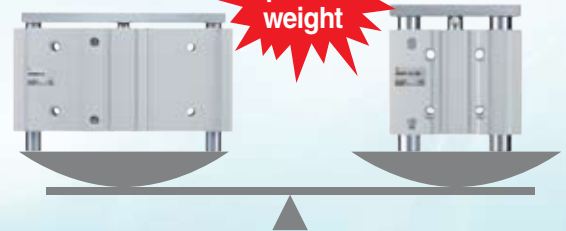

Series MGPW

SMC
CAT.NAS20-228A

Compact Guide Cylinder/Wide Type

3 bearing types are available for various applications.

Slide bearing Series MGPWM

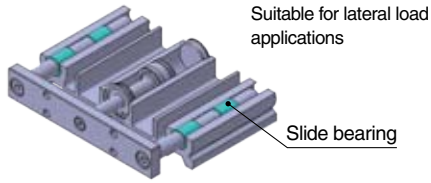

Ball bushing Series MGPWL

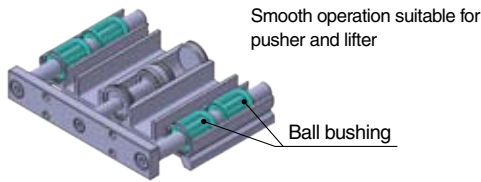

High precision ball bushing Series MGPWA

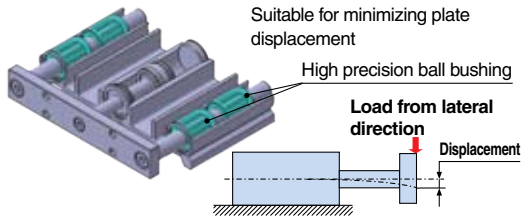

Transfer of large workpieces

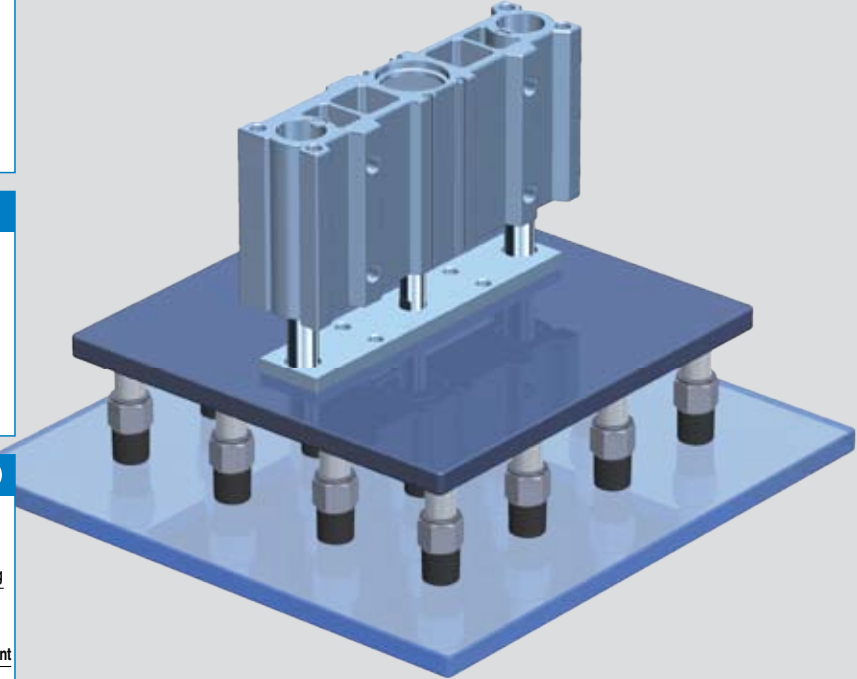

Knock pin hole available as made to order.

If a knock pin is required on the plate or body, "-XC56: With knock pin holes" model is available as a made to order.

Small auto switches or magnetic field resistant auto switches can be mounted on 2 surfaces.

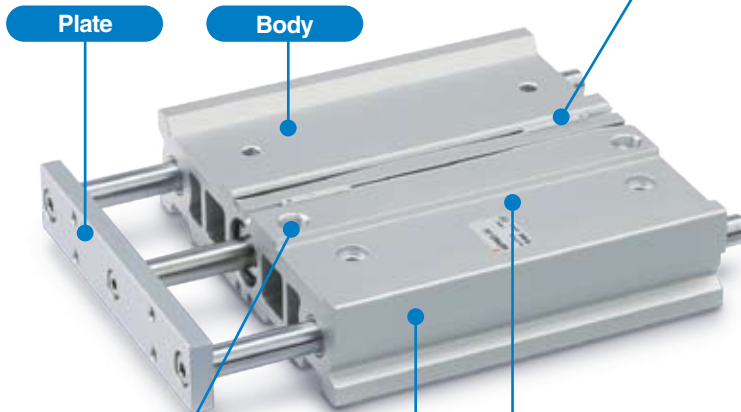

- 2-color display solid state auto switch
D-M9
- Reed auto switch
D-A9
- Magnetic field resistant 2-color display solid state auto switch
D-P3DW

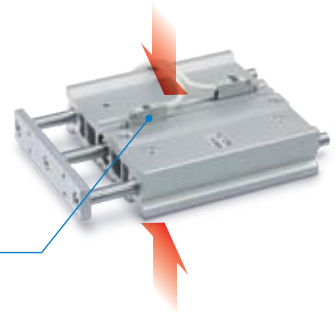

*The D-Y7 and D-Z7 auto switches are not mountable.

Top ported







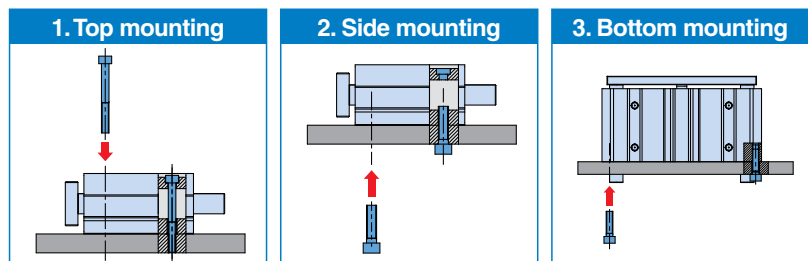







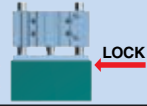



Side porting is available as made to order.

The port is located on the top of the body in the standard type, but if side porting is required, it is also available. (-X867: Side porting type)

3 mounting types are possible.

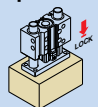

Compact Guide Cylinders, Series Variations

Series	Bearing type	Bore size (mm)											Page				
		6	10	12	16	20	25	32	40	50	63	80		100			
Basic type/MGP 	Slide bearing Ball bushing High precision ball bushing			●	●	●	●	●	●	●	●	●	●	●	●	●	
With air cushion/MGP-A 						●	●	●	●	●	●	●	●	●	●	●	
With end lock/MGP-H/R 						●	●	●	●	●	●	●	●	●	●	●	
Wide type/MGPW New 	Slide bearing Ball bushing High precision ball bushing					●	●	●	●	●	●	●	●	●	●	●	Page 2 of this catalog
Clean series/12/13-MGP 	Ball bushing			●	●	●	●	●	●	●	●	●	●	●	●	●	
Water-resistant/MGP R/V 	Slide bearing					●	●	●	●	●	●	●	●	●	●	●	
Heavy duty guide rod type/MGPS 										●				●			
Miniature Guide Rod Cylinder/MGJ 			●	●													
Compact Guide Cylinder with Lock/MLGP 	Slide bearing Ball bushing					●	●	●	●	●	●	●	●	●	●	●	
Hygienic Design Cylinder/HYG 	Slide bearing					●	●	●	●	●	●	●	●	●	●	●	

New Series MGPW (Wide type), Stroke Variations

Bearing type	Bore size (mm)	Stroke (mm)							
		25	50	75	100	125	150	175	200
MGPWM Slide bearing	20	●	●	●	●	●	●	●	●
	25	●	●	●	●	●	●	●	●
MGPWL Ball bushing	32	●	●	●	●	●	●	●	●
	40	●	●	●	●	●	●	●	●
MGPWA High precision ball bushing	50	●	●	●	●	●	●	●	●
	63	●	●	●	●	●	●	●	●



Series MGPW Specific Product Precautions

Be sure to read before handling. Refer to back cover for Safety Instructions, "Handling Precautions for SMC Products" (M-E03-3) and the Operation Manual for Actuator, Precautions and Auto Switch Precautions. Please download it via our website, <http://www.smcworld.com>

Mounting

Warning

1. Never place your hands or fingers between the plate and the body.

Be very careful to prevent your hands or fingers from getting caught in the gap between the cylinder body and the plate when air is applied.

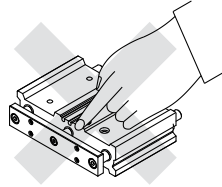

Caution

1. Use cylinders within the piston speed range.

An orifice is set for this cylinder, but the piston speed may exceed the operating range if the speed controller is not used. If the cylinder is used outside the operating speed range, it may cause damage to the cylinder and shorten the service life. Adjust the speed by installing the speed controller and use the cylinder within the limited range.

2. Pay attention to the operating speed when the product is mounted vertically.

When using the product in the vertical direction, if the load factor is large, the operating speed can be faster than the control speed of the speed controller (i.e. quick extension). In such cases, it is recommended to use a dual speed controller.

3. Do not scratch or gouge the sliding portion of the piston rod and the guide rod.

Damaged seals, etc. will result in leakage or malfunction.

4. Do not dent or scratch the mounting surface of a body and a plate.

The flatness of the mounting surface may not be maintained, which would cause an increase in sliding resistance.

5. Make sure that the cylinder mounting surface has a flatness of 0.05 mm or less.

Insufficient flatness of a workpiece or bracket mounted on the mounting surface or plate of the cylinder and other parts can cause defective operation and an increase in the sliding resistance.

6. Bottom of cylinder

The guide rods protrude from the bottom of the cylinder at the end of the retracting stroke, and therefore, in cases where the cylinder is to be bottom mounted, it is necessary to provide bypass ports in the mounting surface for the guide rods, as well as holes for the hexagon socket head cap screws which are used for mounting.

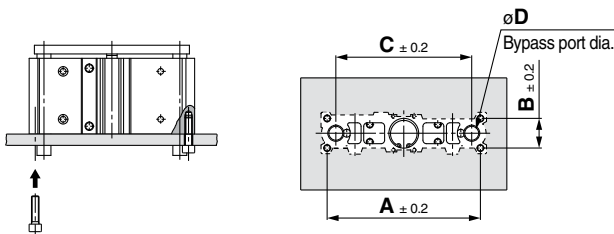

Bore size (mm)	A (mm)	B (mm)	C (mm)	D (mm)		Hexagon socket head cap screw
				MGPWM	MGPWLA	
20	126	24	108	12	12	M5 x 0.8
25	146	30	128	14	15	M6 x 1.0
32	176	34	156	18	18	M8 x 1.25
40	192	40	172	18	18	M8 x 1.25
50	240	46	220	22	22	M10 x 1.5
63	266	58	248	22	22	M10 x 1.5

Mounting

Caution

7. Tighten the screws to the correct tightening torques specified in the table below when mounting parts on top of the cylinder.

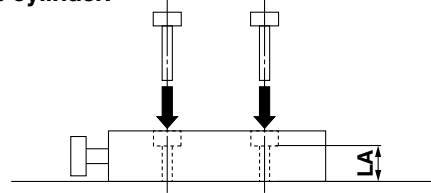

Bore size (mm)	Hexagon socket head cap screw	Tightening torque lbf-ft (N-m)	LA dimension (mm)
20	M5	2.21 to 2.95 (3.0 to 4.0)	30.5
25			36.5
32	M6	3.84 to 4.72 (5.2 to 6.4)	40.5
40			46.5
50	M8	9.22 to 11.4 (12.5 to 15.5)	54.5
63			68.5

Allowable Kinetic Energy

Caution

Load mass and a maximum speed must be within the ranges shown in the graph below.

MGPW with Rubber Bumper

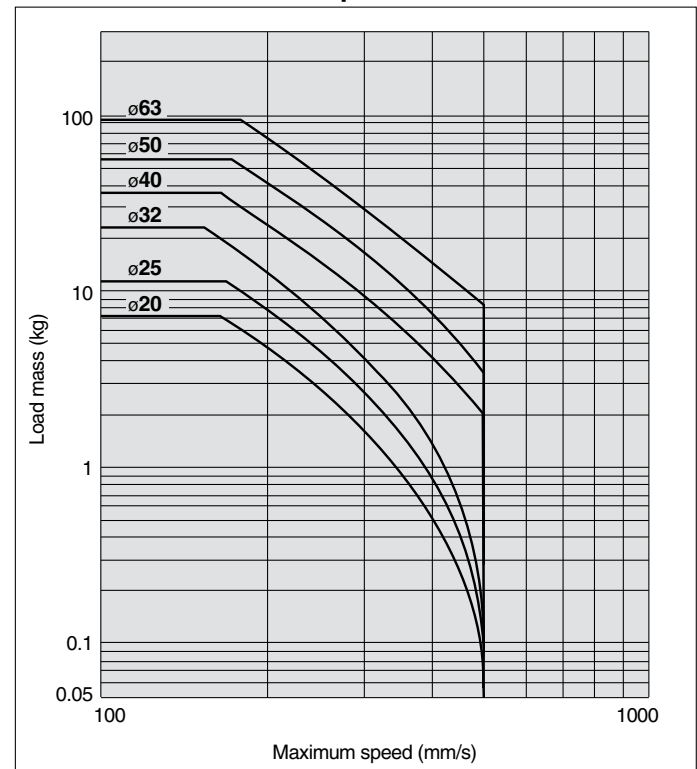

Other

Caution

Do not use this cylinder as a stopper.

Compact Guide Cylinder/Wide Type

Series **MGPW**

ø20, ø25, ø32, ø40, ø50, ø63

How to Order

Compact Guide Cylinder

MGPW **M** **25** - **50** - **M9BW**

Compact Guide Cylinder

Wide type

Bearing type

M	Slide bearing
L	Ball bushing
A	High precision ball bushing

Bore size

20	20 mm	40	40 mm
25	25 mm	50	50 mm
32	32 mm	63	63 mm

Port thread type

Nil	Rc
TN	NPT
TF	G

Number of auto switches

Nil	2 pcs.
S	1 pc.
n	n pcs.

Auto switch

Nil	Without auto switch (Built-in magnet)
------------	---------------------------------------

* For applicable auto switch model, refer to the table below.

Cylinder stroke (mm)

Refer to "Standard Strokes" on page 3.

Applicable Auto Switches/Refer to pages 1719 to 1827 in Best Pneumatics No. 3 for further information on auto switches.

Type	Special function	Electrical entry	Indicator light	Wiring (Output)	Load voltage		Auto switch model		Lead wire length (m)				Pre-wired connector	Applicable load		
					DC	AC	Perpendicular	In-line	0.5 (Nil)	1 (M)	3 (L)	5 (Z)				
Solid state auto switch	—	Grommet	Yes	3-wire (NPN)	24 V	5 V, 12 V	—	M9NV	M9N	●	●	●	○	○	IC circuit	
				3-wire (PNP)				M9PV	M9P	●	●	●	○			
				2-wire				M9BV	M9B	●	●	●	○			
	Diagnostic indication (2-color display)			3-wire (NPN)	5 V, 12 V	M9NWV	M9NW	●	●	●	○	○	IC circuit			
				3-wire (PNP)		M9PWV	M9PW	●	●	●	○					
				2-wire		M9B WV	M9BW	●	●	●	○					
	Water-resistant (2-color display)			3-wire (NPN)	5 V, 12 V	M9NAV***	M9NA***	○	○	●	○	○	IC circuit			
				3-wire (PNP)		M9PAV***	M9PA***	○	○	●	○					
				2-wire		M9BAV***	M9BA***	○	○	●	○					
	Magnetic field resistant (2-color display)			2-wire (Non-polar)	—	—	—	—	P3DW**	●	—	●	●	○	○	—
Reed auto switch	—	Grommet	Yes	3-wire (NPN equivalent)	—	5 V	—	A96V	A96	●	—	●	—	—	IC circuit	
				2-wire	24 V	12 V	100 V	A93V	A93	●	—	●	●	—	—	Relay, PLC
							100 V or less	A90V	A90	●	—	●	—	—	—	IC circuit

*** Water-resistant type auto switch can be mounted to the models with the above mentioned part numbers, but this does not guarantee the water resistance of the cylinder. A water-resistant type cylinder is recommended for use in an environment which requires water resistance.

* Lead wire length symbols: 0.5 m Nil (Example) M9NW
 1 m M (Example) M9NWM
 3 m L (Example) M9NWL
 5 m Z (Example) M9NWZ

* Solid state auto switches marked with "○" are produced upon receipt of order.
 ** Bore sizes ø32 to ø63 are available for the D-P3DW.

* Since there are other applicable auto switches than listed, refer to page 19 for details.

* For details about auto switches with pre-wired connector, refer to pages 1784 and 1785 in Best Pneumatics No. 3.
 For the D-P3DW□, refer to the catalog CAT. ES20-201.

* Auto switches are shipped together, (but not assembled).

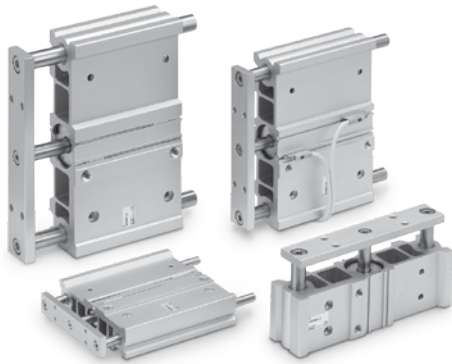

Specifications

Bore size (mm)	20	25	32	40	50	63
Action	Double acting					
Fluid	Air					
Proof pressure	218 psi (1.5 MPa)					
Maximum operating pressure	145 psi (1.0 MPa)					
Minimum operating pressure	14.5 psi (0.1 MPa)					
Ambient and fluid temperature	14 to 140 °F (-10 to 60°C) (No freezing)					
Piston speed ^{Note)}	50 to 500 mm/s					
Cushion	Rubber bumper on both ends					
Lubrication	Not required (Non-lube)					
Stroke length tolerance	+1.5 0 mm					

Note) Speed with no load

Standard Strokes

Bore size (mm)	Standard stroke (mm)
20 to 63	25, 50, 75, 100, 125, 150, 175, 200

Manufacture of Intermediate Strokes

Description	Spacer installation Spacers are installed in the standard stroke cylinder. • ø20 to ø32: Available by the 1 mm stroke interval. • ø40 to ø63: Available by the 5 mm stroke interval.	
Part no.	Refer to "How to Order" for the standard model numbers.	
Applicable stroke (mm)	ø20 to ø32	1 to 199
	ø40 to ø63	5 to 195
Example	Part no.: MGPWM20-49 A spacer 1 mm in width is installed in a MGPWM20-50. C dimension (Body length): 84 mm	

Refer to pages 18 to 20 for cylinders with auto switches.

- Auto switch proper mounting position (detection at stroke end) and its mounting height
- Minimum stroke for auto switch mounting
- Auto switch mounting brackets/Part no.



Made to Order
(For details, refer to pages 22 and 23.)

Symbol	Description
-XC56	With knock pin holes
-X867	Side porting type

Theoretical Output

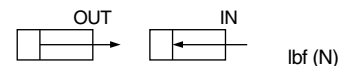

Bore size (mm)	Rod size (mm)	Operating direction	Piston area (mm ²)	Operating pressure psi (MPa)								
				29 (0.2)	44 (0.3)	58 (0.4)	73 (0.5)	87 (0.6)	102 (0.7)	116 (0.8)	131 (0.9)	145 (1.0)
20	10	OUT	314	14.2 (63)	21.2 (94)	28.3 (126)	35.3 (157)	42.3 (188)	49.5 (220)	56.4 (251)	63.6 (283)	70.6 (314)
		IN	236	10.6 (47)	16.0 (71)	21.1 (94)	26.5 (118)	31.7 (141)	37.1 (165)	42.3 (188)	47.6 (212)	53.1 (236)
25	10	OUT	491	22.0 (98)	33.0 (147)	44.0 (196)	55.1 (245)	66.3 (295)	77.3 (344)	88.3 (393)	99.4 (442)	110.4 (491)
		IN	412	18.4 (82)	27.9 (124)	37.1 (165)	46.3 (206)	55.5 (247)	65.0 (289)	74.2 (330)	83.4 (371)	92.6 (412)
32	14	OUT	804	36.2 (161)	54.2(241)	72.4 (322)	90.4 (402)	108.6 (483)	126.6 (563)	144.6 (643)	162.8 (724)	180.7 (804)
		IN	650	29.2 (130)	43.8 (195)	58.4 (260)	73.1 (325)	87.7 (390)	102.3 (455)	116.9 (520)	131.5 (585)	146.1 (650)
40	14	OUT	1257	56.4 (251)	84.8(377)	113.0 (503)	141.2 (628)	169.5 (754)	197.8 (880)	226.0 (1005)	254.3 (1131)	282.6 (1257)
		IN	1103	49.7 (221)	74.4 (331)	99.1 (441)	123.9 (551)	148.8 (662)	173.6 (772)	198.3 (882)	223.0 (992)	248.0 (1103)
50	18	OUT	1963	88.3 (393)	132.4 (589)	176.5 (785)	220.8 (982)	264.8 (1178)	308.9 (1374)	353.2 (1571)	397.2 (1767)	441.3 (1963)
		IN	1709	76.9 (342)	115.3 (513)	153.8 (684)	192.2 (855)	230.4 (1025)	268.8 (1196)	307.3 (1367)	345.8 (1538)	384.2 (1709)
63	18	OUT	3117	140.4 (623)	210.1 (935)	280.3 (1247)	350.5 (1559)	420.4 (1870)	490.5 (2182)	560.7 (2494)	630.8 (2806)	700.7 (3117)
		IN	2863	128.8 (573)	193.1 (859)	257.4 (1145)	321.7 (1431)	386.2 (1718)	450.5 (2004)	514.8 (2290)	579.1 (2576)	643.6 (2863)

Note) Theoretical output (N) = Pressure (MPa) x Piston area (mm²)

Weight

Slide Bearing: MGPWM

(kg)

Bore size (mm)	Standard stroke (mm)							
	25	50	75	100	125	150	175	200
20	0.63	0.86	1.11	1.33	1.54	1.76	1.98	2.20
25	0.84	1.11	1.47	1.74	2.01	2.28	2.55	2.82
32	1.31	1.71	2.22	2.61	3.00	3.38	3.77	4.15
40	1.53	1.98	2.54	2.97	3.40	3.83	4.26	4.69
50	2.45	3.12	4.01	4.66	5.31	5.96	6.61	7.26
63	3.25	4.07	5.12	5.91	6.71	7.51	8.31	9.11

Ball Bushing: MGPWL/High Precision Ball Bushing: MGPWA

(kg)

Bore size (mm)	Standard stroke (mm)							
	25	50	75	100	125	150	175	200
20	0.65	0.92	1.15	1.37	1.61	1.83	2.05	2.28
25	0.89	1.23	1.52	1.81	2.11	2.40	2.68	2.97
32	1.36	1.76	2.22	2.61	3.03	3.41	3.80	4.18
40	1.58	2.02	2.53	2.96	3.43	3.86	4.29	4.72
50	2.51	3.19	3.94	4.59	5.26	5.91	6.55	7.20
63	3.32	4.14	5.04	5.84	6.66	7.46	8.26	9.06

1 kg = 2.2 lb

Allowable Rotational Torque of Plate

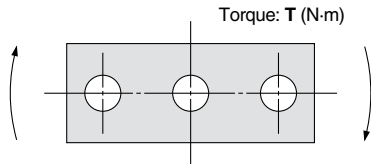

T (N-m)

Bore size (mm)	Bearing type	Stroke (mm)							
		25	50	75	100	125	150	175	200
20	MGPWM	2.10	1.63	1.74	1.51	1.34	1.20	1.08	0.99
	MGPWL/A	3.97	4.36	3.46	2.87	3.93	3.45	3.07	2.76
25	MGPWM	3.53	2.74	3.28	2.90	2.59	2.34	2.14	1.97
	MGPWL/A	6.88	6.78	5.43	4.51	6.27	5.51	4.90	4.40
32	MGPWM	7.98	6.39	7.00	6.19	5.54	5.02	4.59	4.22
	MGPWL/A	11.13	8.48	11.14	9.36	12.46	11.00	9.83	8.87
40	MGPWM	8.80	7.04	7.72	6.82	6.11	5.54	5.06	4.66
	MGPWL/A	12.26	9.34	12.27	10.31	13.73	12.12	10.83	9.77
50	MGPWM	17.57	14.28	16.17	14.44	13.04	11.89	10.93	10.11
	MGPWL/A	17.08	13.20	19.64	16.62	20.45	18.10	16.19	14.61
63	MGPWM	19.80	16.09	18.23	16.28	14.70	13.41	12.32	11.40
	MGPWL/A	19.18	14.81	22.07	18.66	22.98	20.33	18.18	16.39

1 N-m = 0.737 lbf-ft

Non-rotating Accuracy of Plate

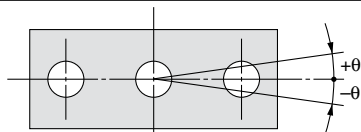

Non-rotating accuracy θ when the plate is retracted and when no load is applied is not more than the values shown in the table as a guide line.

Bore size (mm)	Non-rotating accuracy θ		
	MGPWM	MGPWL	MGPWA
20	$\pm 0.05^\circ$	$\pm 0.03^\circ$	$\pm 0.01^\circ$
25	$\pm 0.04^\circ$		
32			
40			
50	$\pm 0.03^\circ$		
63			

Series MGPW

High Precision Ball Bushing/MGPWA Plate Displacement Amount (Reference Values)

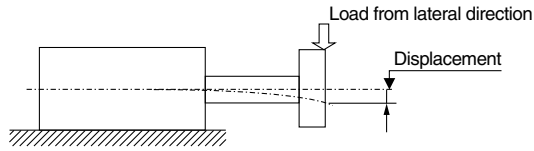

MGPWA20

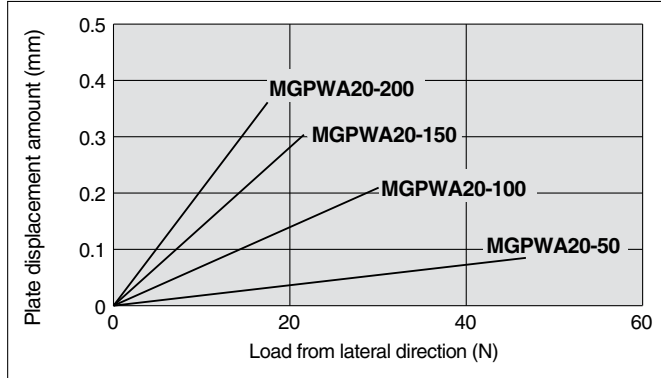

MGPWA32, 40

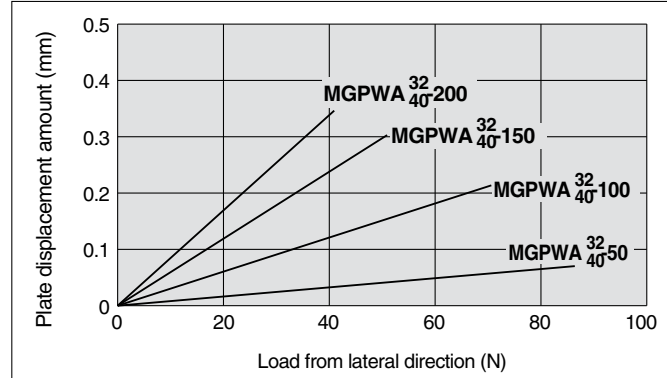

MGPWA25

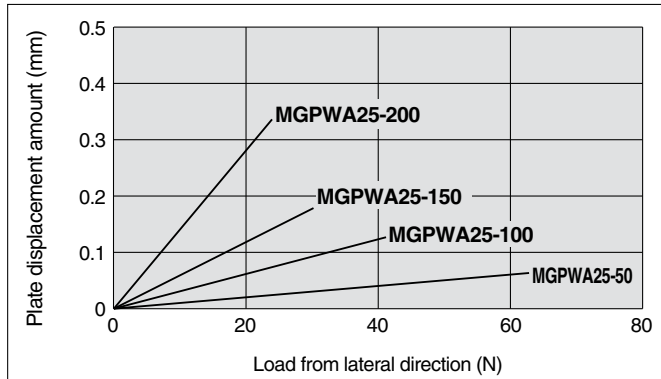

MGPWA50, 63

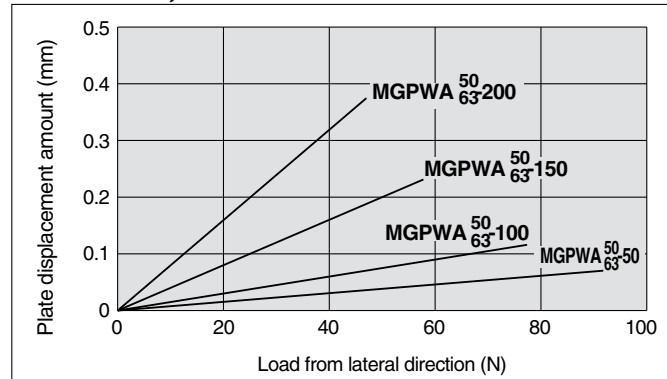

Note 1) The guide rod and self-weight for the plate are not included in the above displacement values.

Note 2) Allowable rotating torque, and operating range when used as a lifter, are the same as MGPWL series.

1 N = 0.2248 lbf

Series MGPW Model Selection

Selection Conditions

Mounting orientation	Vertical		Horizontal	
Maximum speed (mm/s)	200 or less	400	200 or less	400
Graph (Slide bearing type)	(1), (2)	(3), (4)	(17), (18)	(19), (20)
Graph (Ball bushing type)	(5) to (10)	(11) to (16)	(21) to (24)	(25) to (28)

Selection Example 1 (Vertical Mounting)

Selection conditions

Mounting: Vertical
 Bearing type: Ball bushing
 Stroke: 50 stroke
 Maximum speed: 200 mm/s
 Load mass: 5 kg
 Eccentric distance: 90 mm

Find the point of intersection for the load mass of 3 kg and the eccentric distance of 90 mm on graph (6), based on vertical mounting, ball bushing, 50 stroke, and the speed of 200 mm/s.

→ **MGPWL20-50** is selected.

(6) 26 to 100 stroke, V = 200 mm/s or less

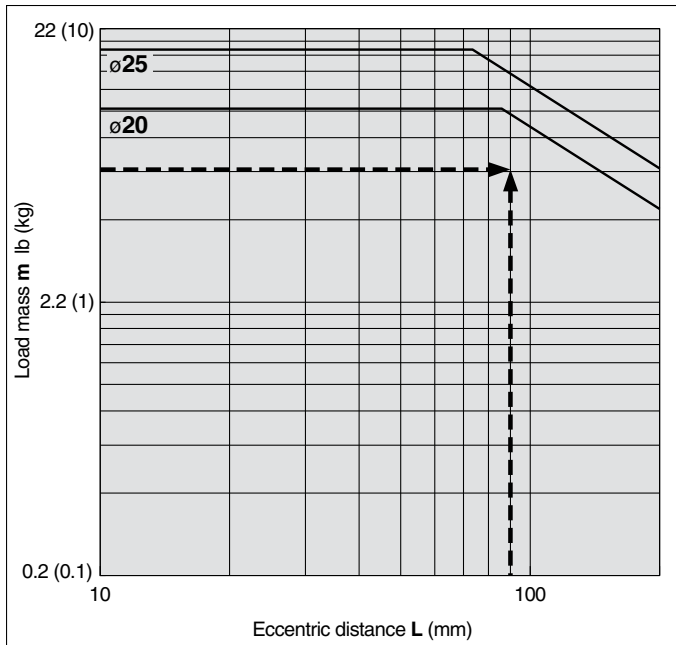

Selection Example 2 (Horizontal Mounting)

Selection conditions

Mounting: Horizontal
 Bearing type: Slide bearing
 Distance between plate and load center of gravity: 50 mm
 Maximum speed: 200 mm/s
 Load mass: 2 kg
 Stroke: 30 stroke

Find the point of intersection for the load mass of 2 kg and 30 stroke on graph (17), based on horizontal mounting, slide bearing, the distance of 50 mm between the plate and load center of gravity, and the speed of 200 mm/s.

→ **MGPWM20-30** is selected.

(17) L = 50 mm, V = 200 mm/s or less

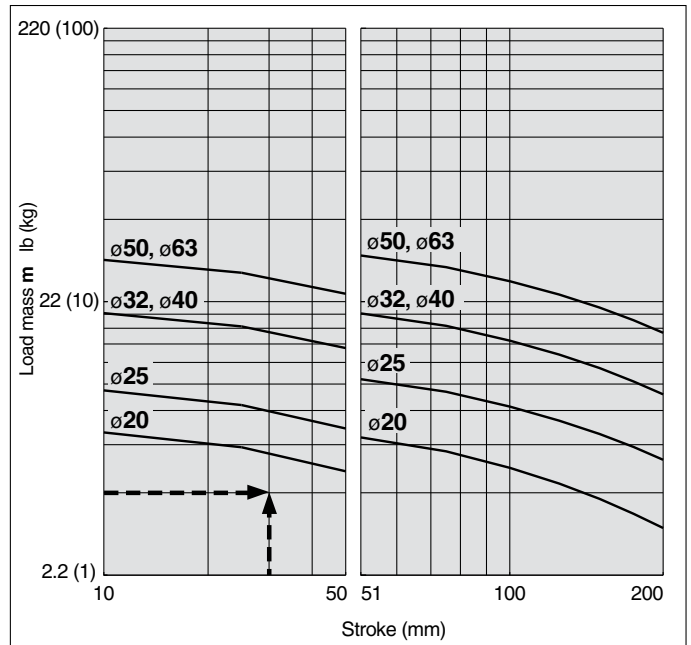

When the maximum speed exceeds 200 mm/s, the allowable load mass is determined by multiplying the value shown in the graph at 400 mm/s by the coefficient listed in the table below.

Max. speed	Up to 300 mm/s	Up to 400 mm/s	Up to 500 mm/s
Coefficient	1.7	1	0.6

Series MGPW

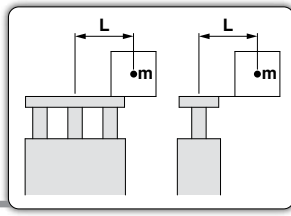

Vertical Mounting **Slide bearing**

Operating pressure 73 psi (0.5 MPa)

MGPWM20 to 63

(1) 50 stroke or less, V = 200 mm/s or less

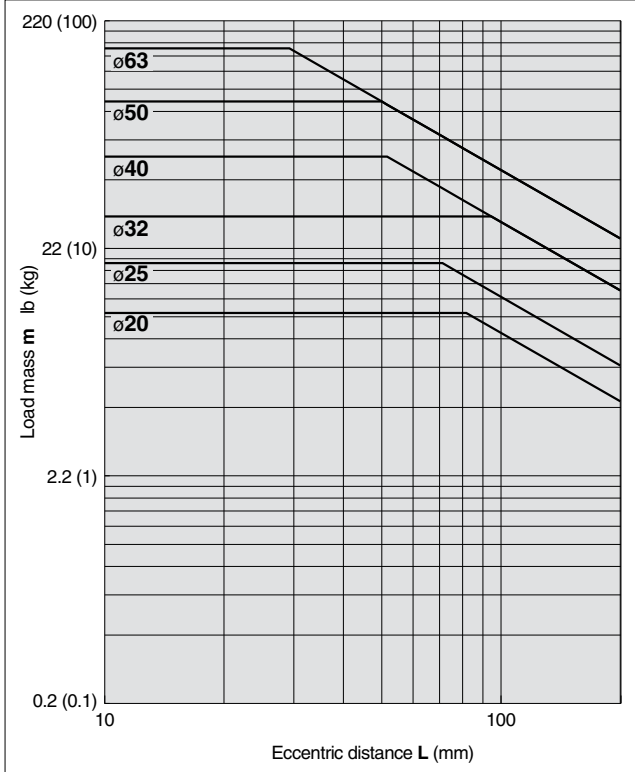

(2) Over 50 stroke, V = 200 mm/s or less

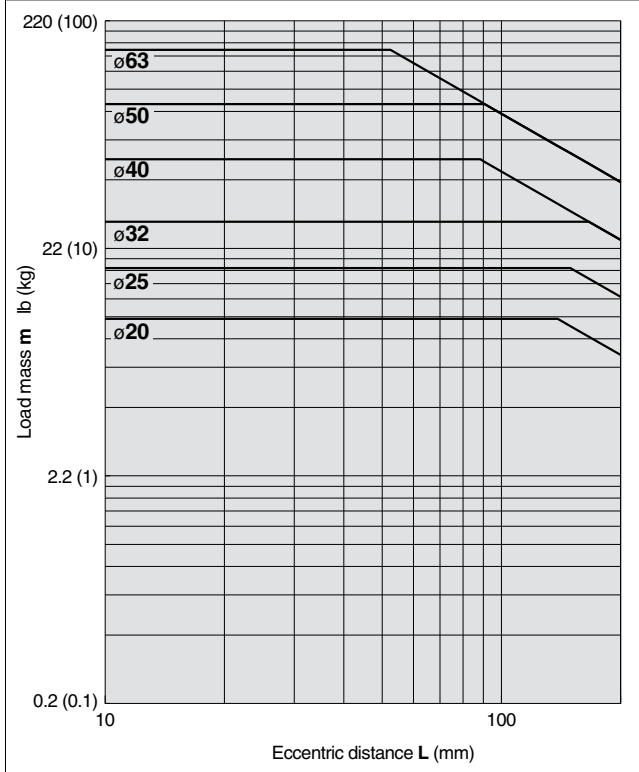

(3) 50 stroke or less, V = 400 mm/s or less

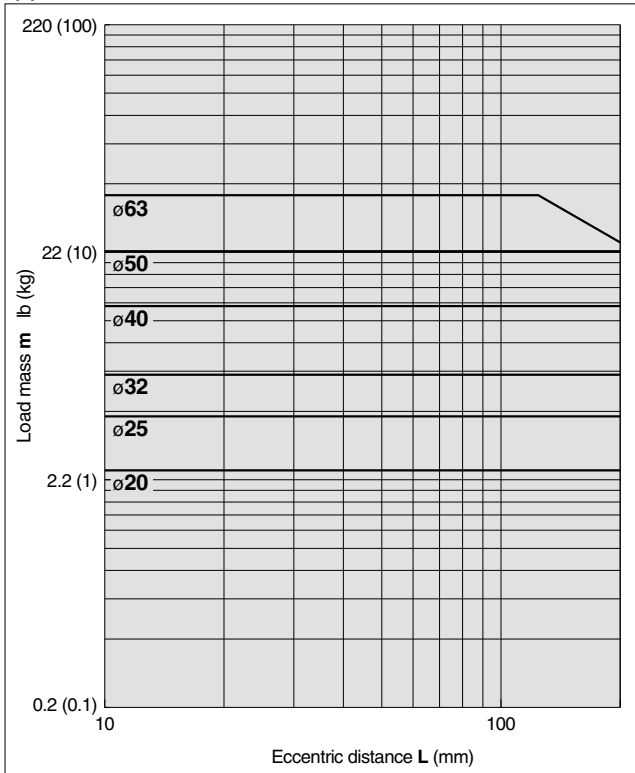

(4) Over 50 stroke, V = 400 mm/s or less

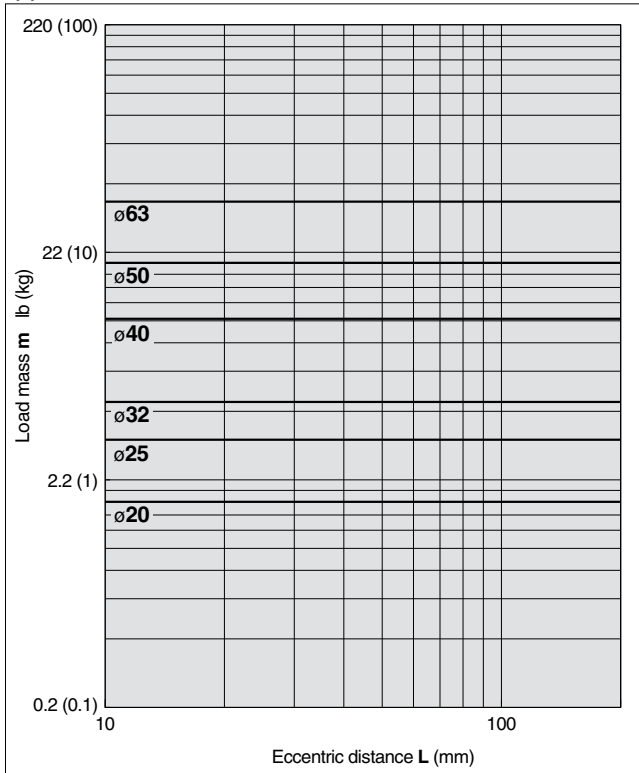

Vertical Mounting **Ball bushing**

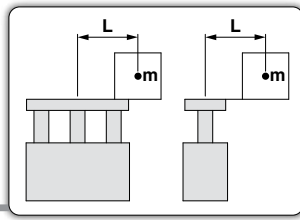

Operating pressure 73 psi (0.5 MPa)

MGPWL20 to 25, MGPWA20 to 25

(5) 25 stroke or less, V = 200 mm/s or less

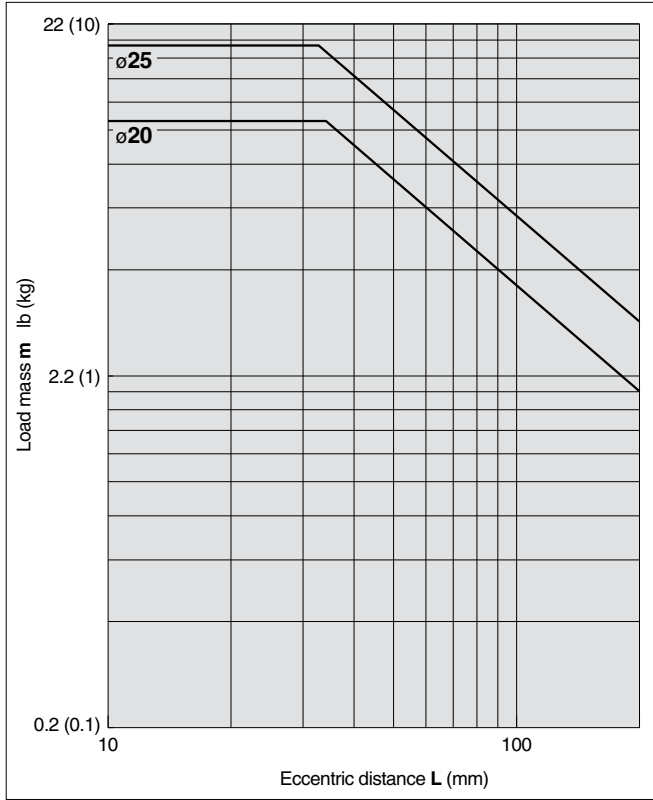

(6) Over 26 stroke, 100 stroke or less, V = 200 mm/s or less

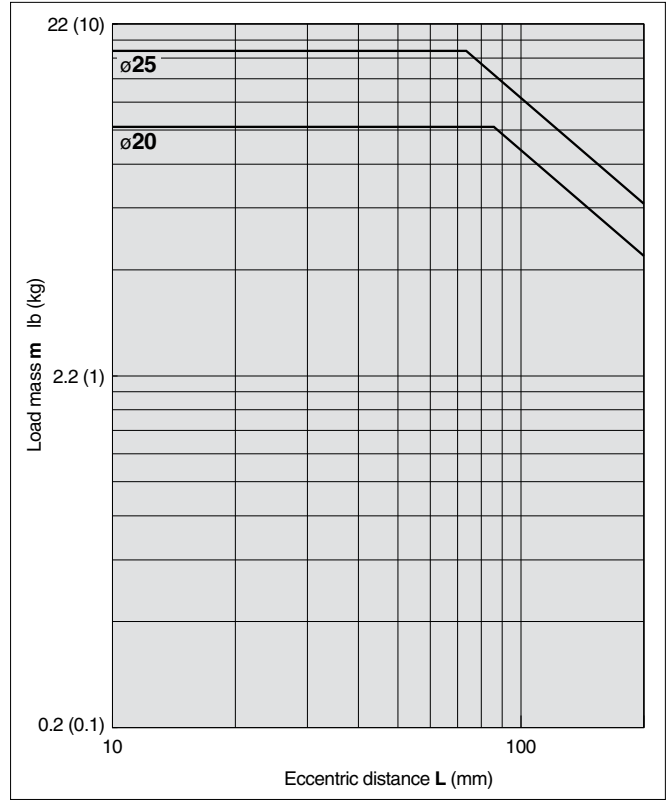

(7) Over 101 stroke, 200 stroke or less, V = 200 mm/s or less

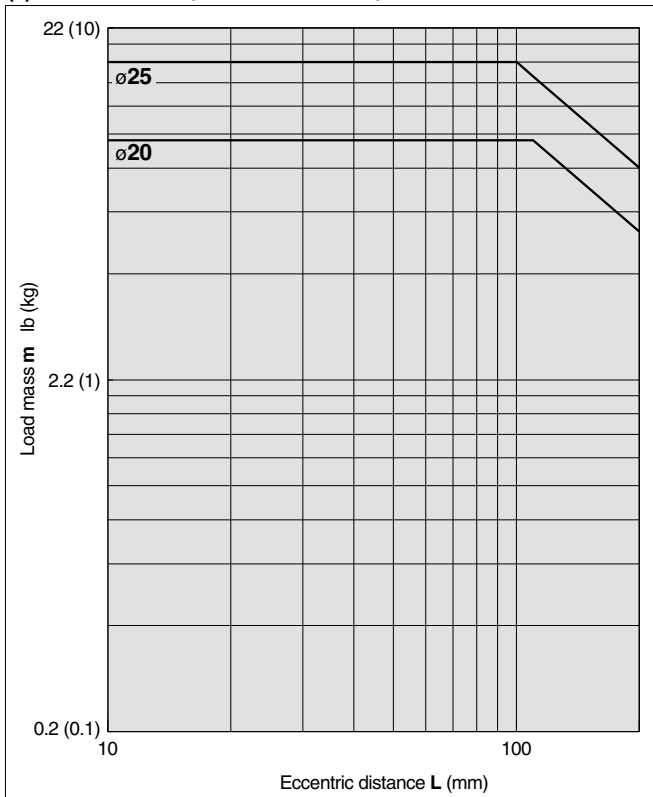

Series MGPW

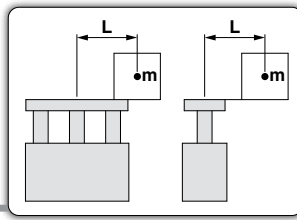

Vertical Mounting **Ball bushing**

— Operating pressure 73 psi (0.5 MPa)

MGPWL32 to 63, MGPWA32 to 63

(8) 50 stroke or less, V = 200 mm/s or less

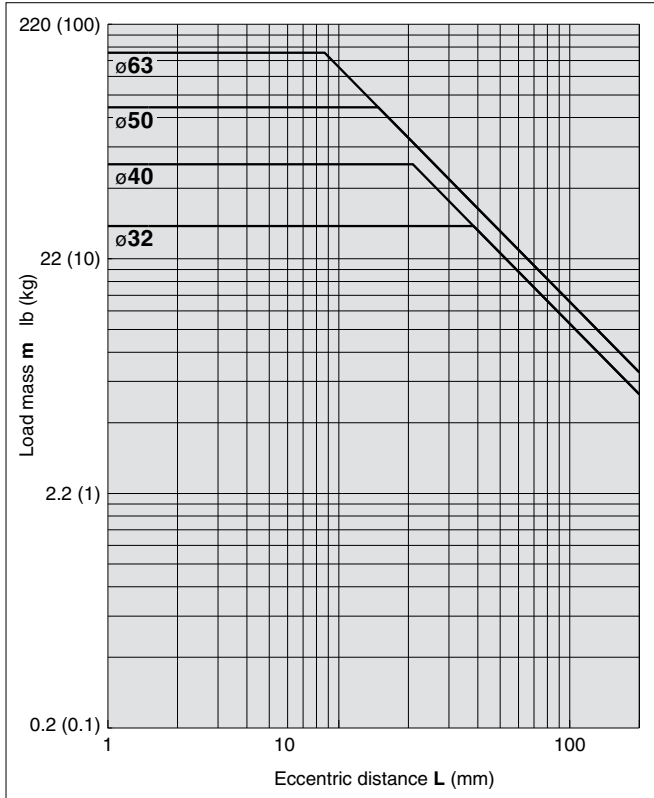

(9) Over 51 stroke, 100 stroke or less, V = 200 mm/s or less

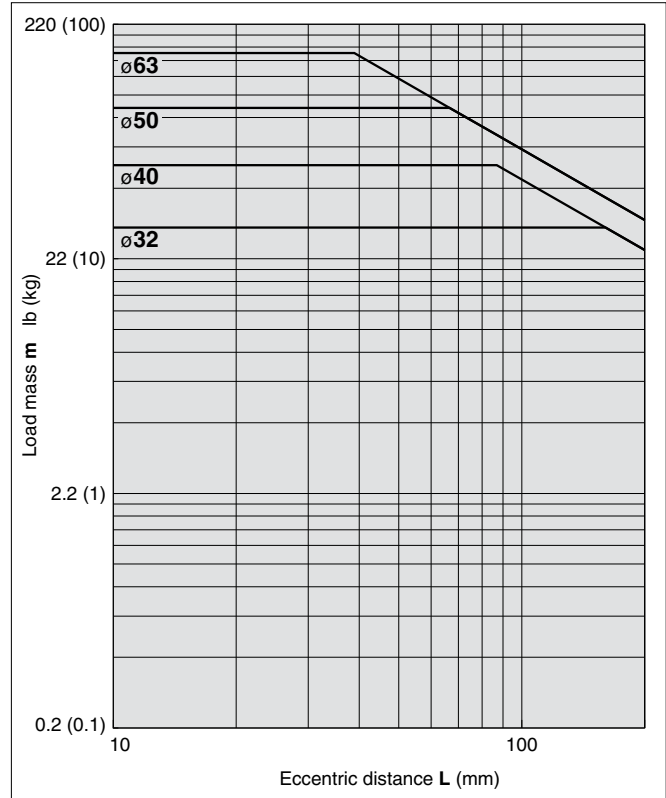

(10) Over 101 stroke, 200 stroke or less, V = 200 mm/s or less

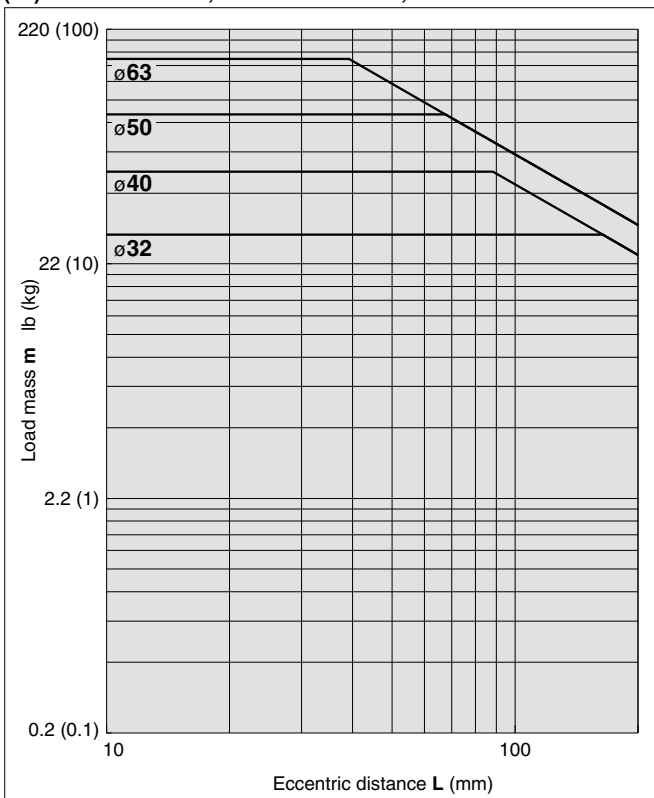

Vertical Mounting

Ball bushing

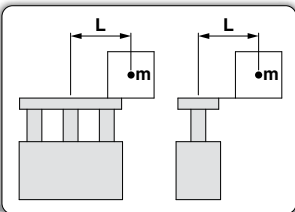

Operating pressure 73 psi (0.5 MPa)

MGPWL20 to 25, MGPWA20 to 25

(11) 25 stroke or less, V = 400 mm/s

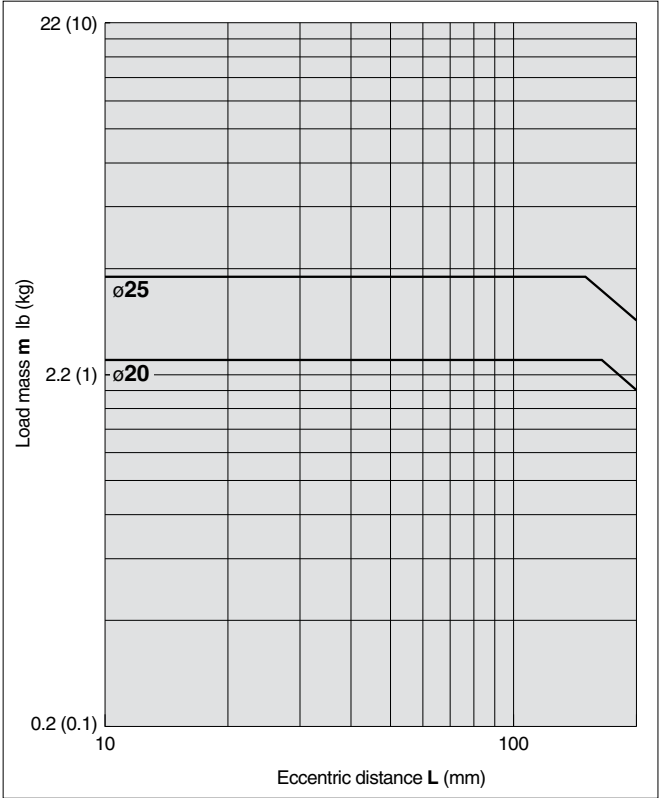

(12) Over 26 stroke, 100 stroke or less, V = 400 mm/s

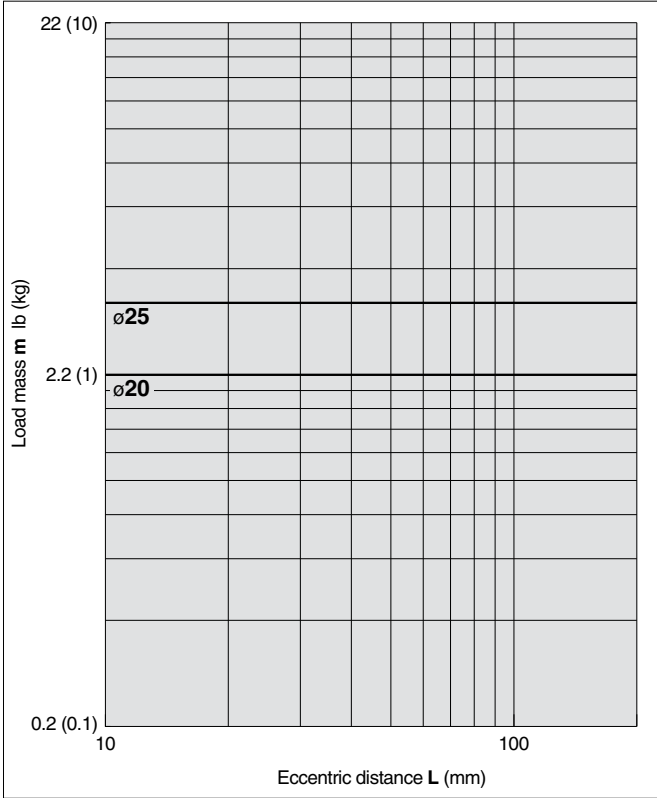

(13) Over 101 stroke, 200 stroke or less, V = 400 mm/s

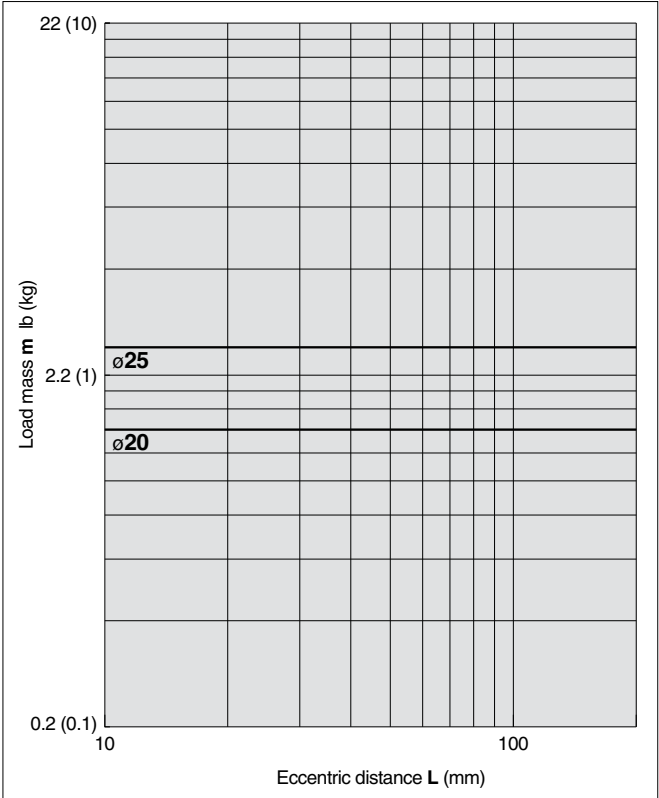

Series MGPW

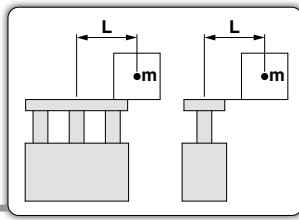

Vertical Mounting **Ball bushing**

Operating pressure 73 psi (0.5 MPa)

MGPWL32 to 63, MGPWA32 to 63

(14) 50 stroke or less, $V = 400$ mm/s

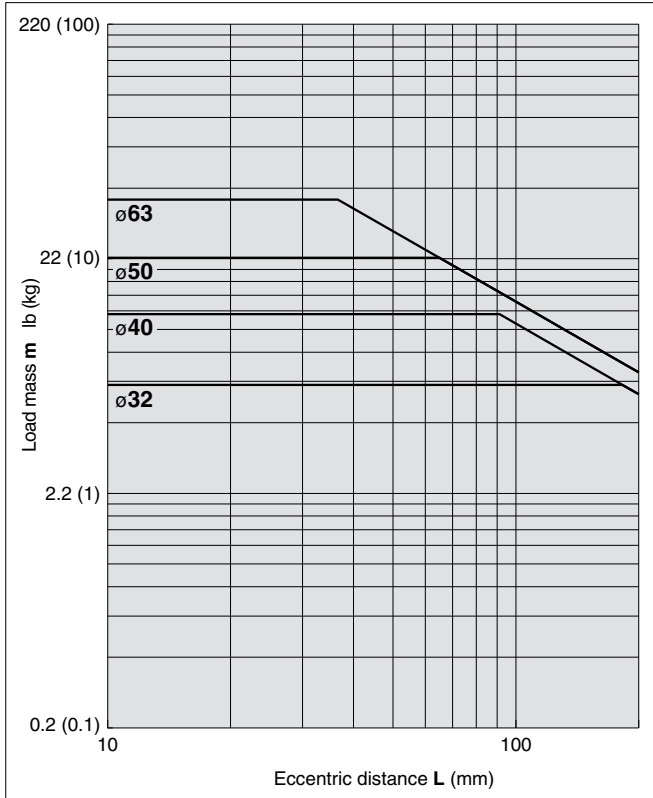

(15) Over 51 stroke, 100 stroke or less, $V = 400$ mm/s

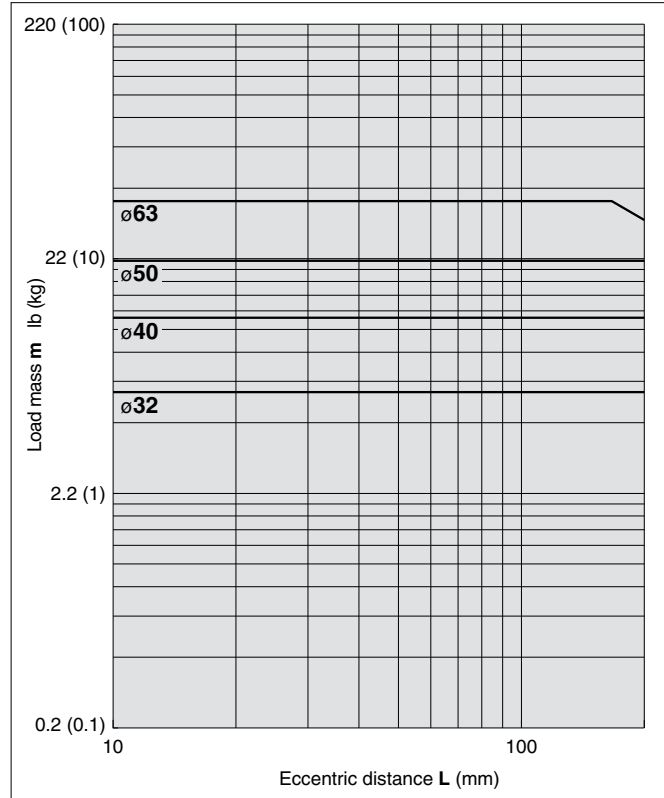

(16) Over 101 stroke, 200 stroke or less, $V = 400$ mm/s

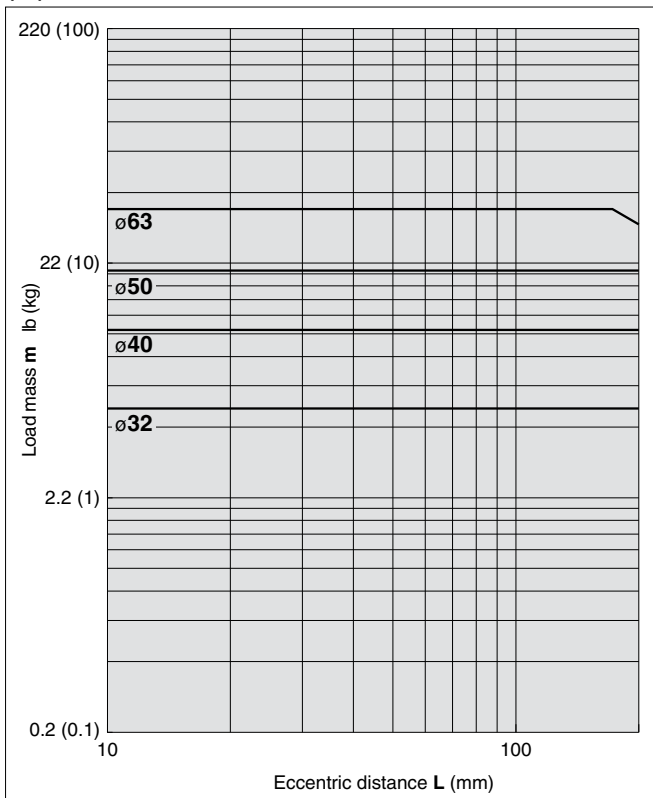

Horizontal Mounting **Slide bearing**

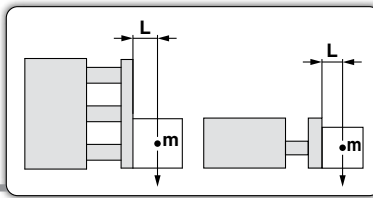

MGPWM20 to 63

(17) L = 50 mm, V = 200 mm/s or less

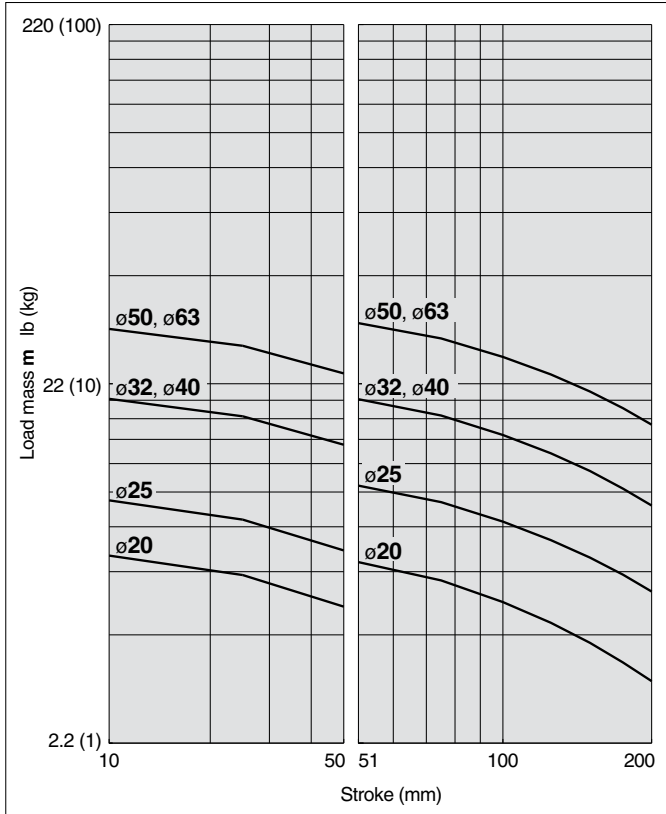

(18) L = 100 mm, V = 200 mm/s or less

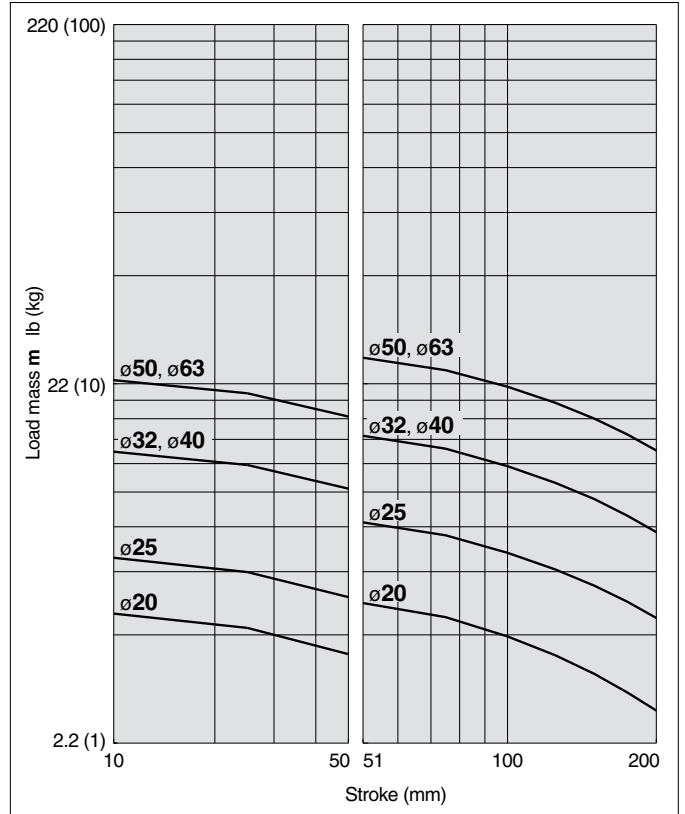

(19) L = 50 mm, V = 400 mm/s

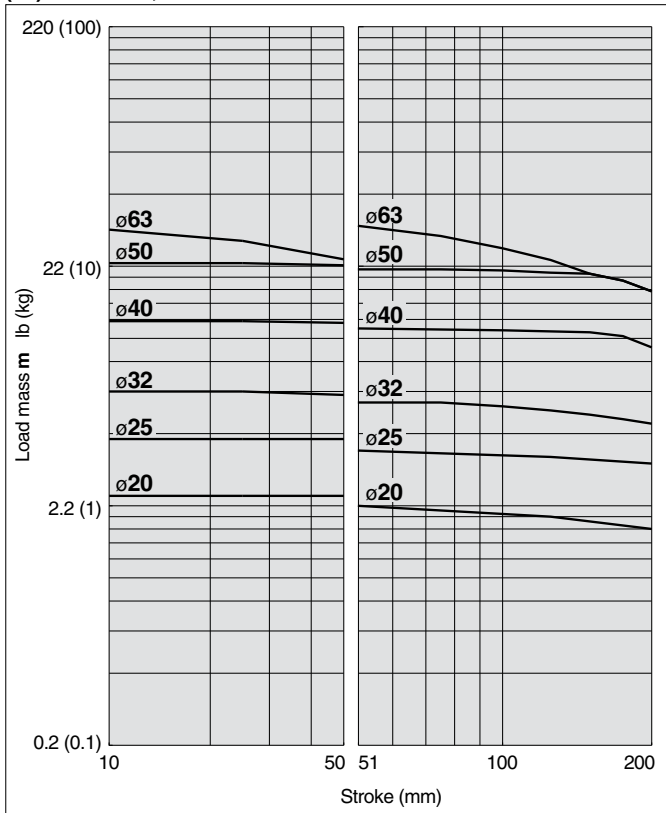

(20) L = 100 mm, V = 400 mm/s

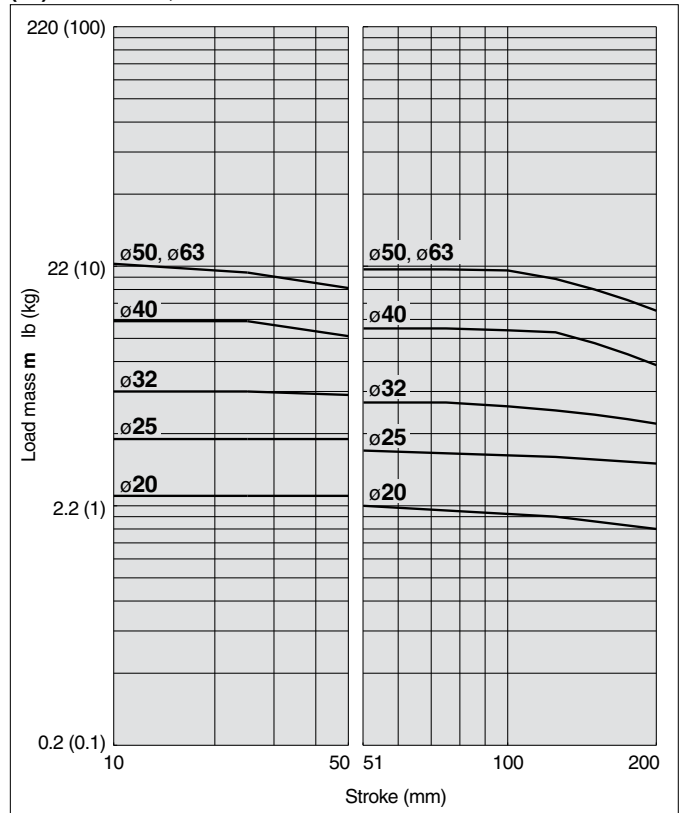

Series MGPW

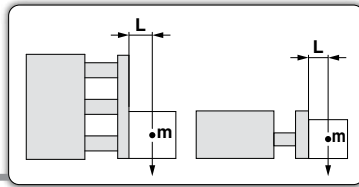

Horizontal Mounting **Ball bushing**

MGPWL20 to 25, MGPWA20 to 25

(21) L = 50 mm, V = 200 mm/s or less

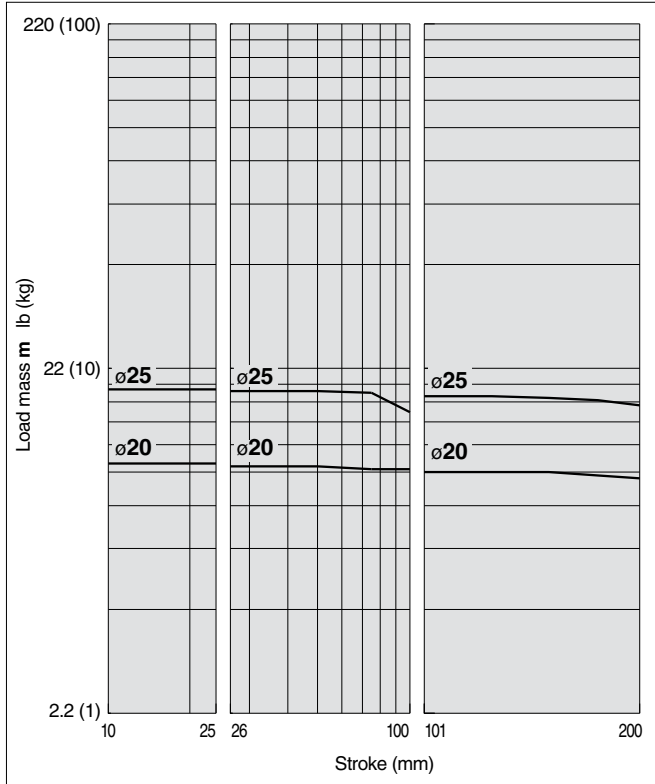

(22) L = 100 mm, V = 200 mm/s or less

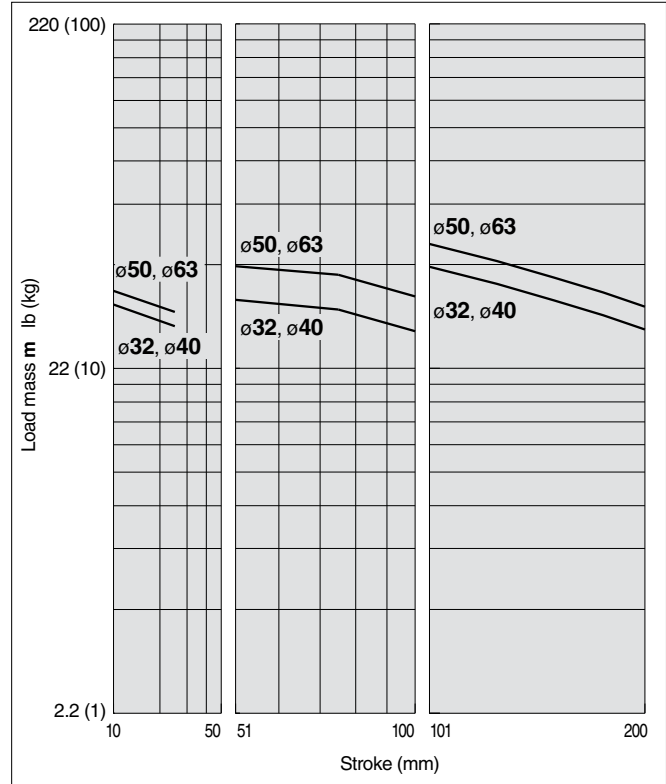

MGPWL32 to 63, MGPWA32 to 63

(23) L = 50 mm, V = 200 mm/s or less

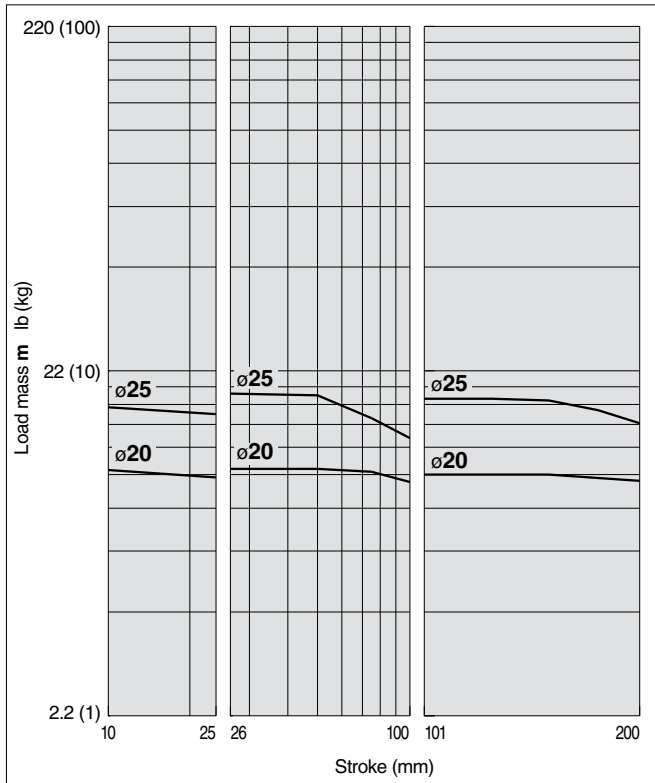

(24) L = 100 mm, V = 200 mm/s or less

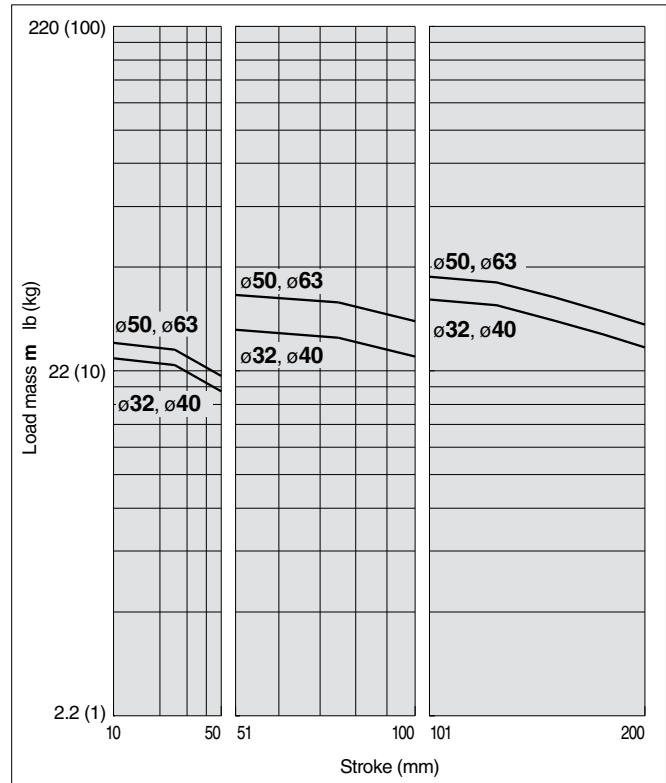

Horizontal Mounting **Ball bushing**

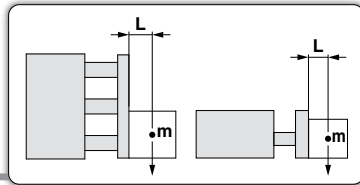

MGPWL20 to 25, MGPWA20 to 25

(25) L = 50 mm, V = 400 mm/s or less

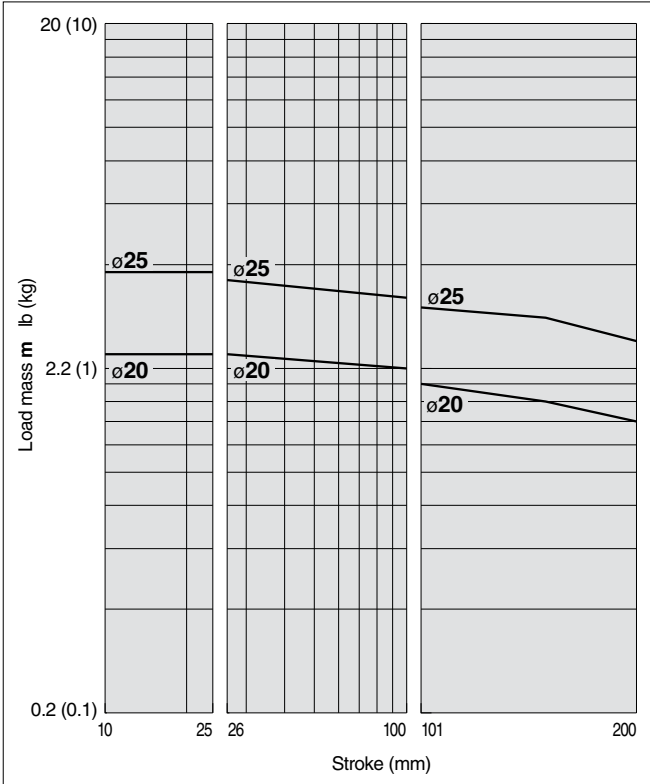

(26) L = 100 mm, V = 400 mm/s or less

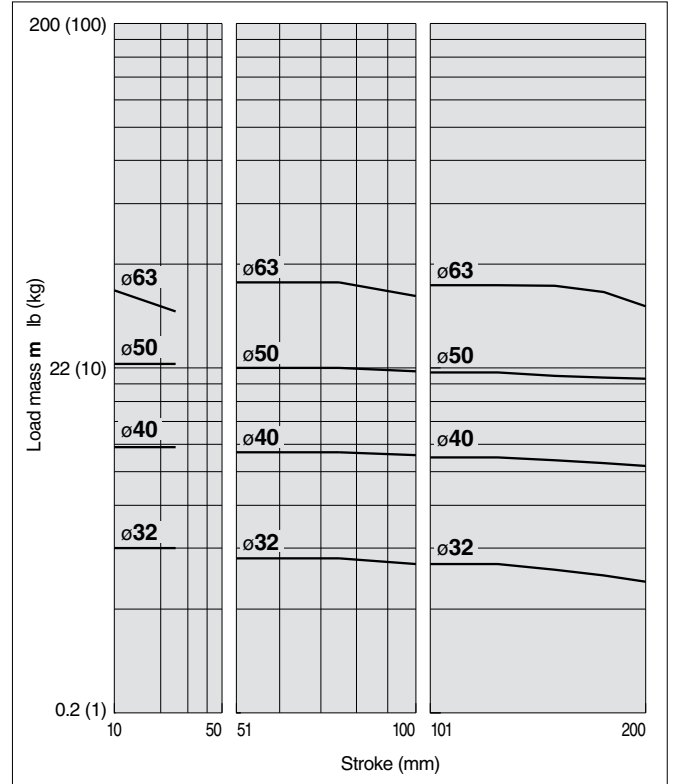

MGPWL32 to 63, MGPWA32 to 63

(27) L = 50 mm, V = 400 mm/s or less

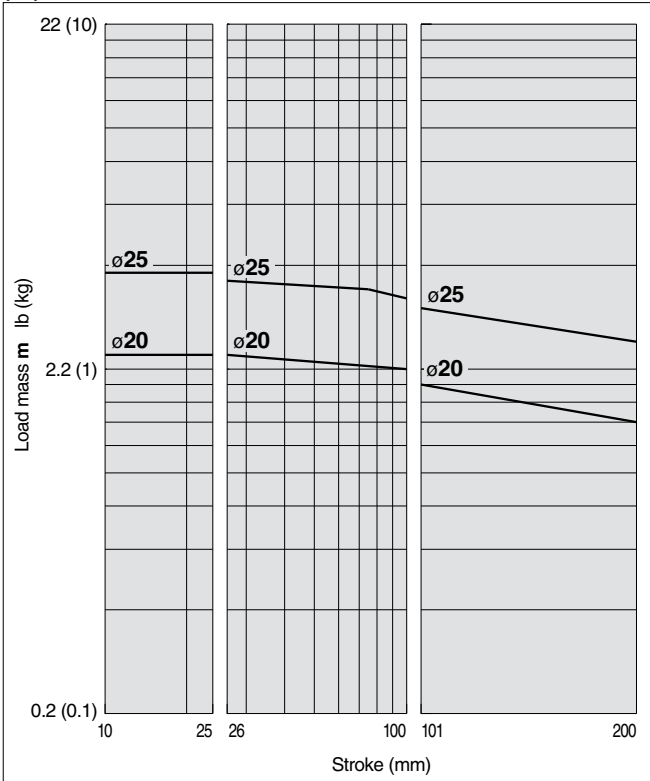

(28) L = 100 mm, V = 400 mm/s or less

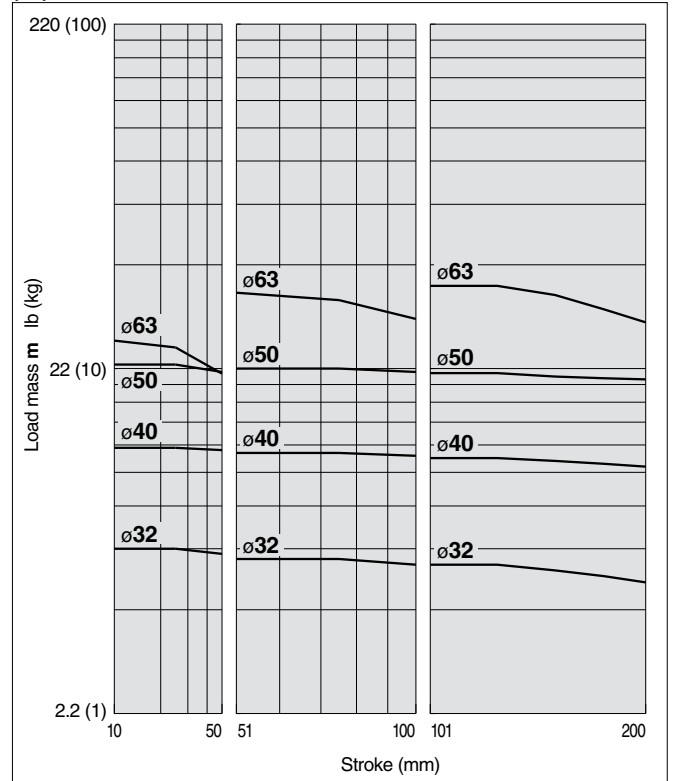

Series MGPW

Construction/Series MGPWM, MGPWL, MGPWA

MGPWM20 to 63

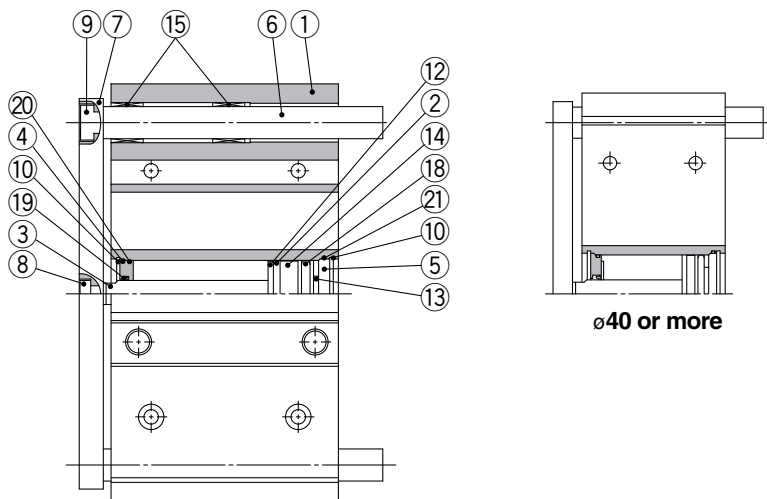

MGPWL20 to 63 MGPWA20 to 63

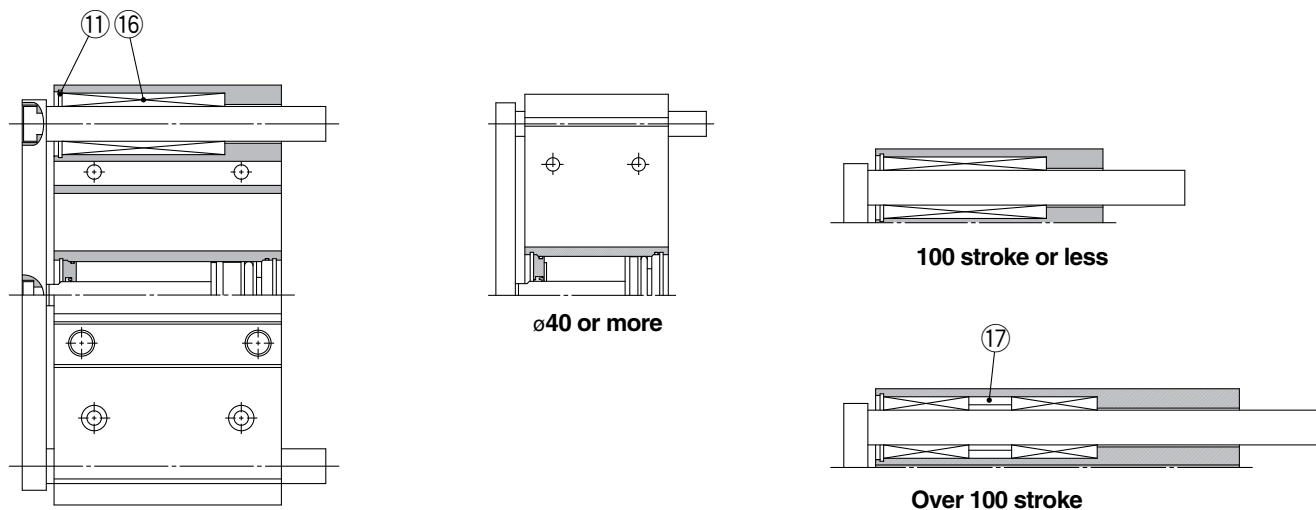

Component Parts

No.	Description	Material	Note
1	Body	Aluminum alloy	Hard anodized
2	Piston	Aluminum alloy	Chromated
3	Piston rod	Stainless steel	ø20 to ø25
		Carbon steel	ø32 to ø63 Hard chrome plated
4	Collar	Aluminum alloy	Chromated
5	Head cover	Aluminum alloy	Chromated
6	Guide rod	Carbon steel	Hard chrome plated
7	Plate	Aluminum alloy	Anodized
8	Plate mounting bolt	Carbon steel	Nickel plated
9	Guide bolt	Carbon steel	Nickel plated
10	Retaining ring	Carbon tool steel	Phosphate coated
11	Retaining ring	Carbon tool steel	Phosphate coated
12	Bumper A	Urethane	
13	Bumper B	Urethane	
14	Magnet	-	
15	Slide bearing	Babbitt	

Component Parts

No.	Description	Material	Note
16	Ball bushing		
17	Spacer	Aluminum alloy	
18*	Piston seal	NBR	
19*	Rod seal	NBR	
20*	Gasket A	NBR	
21*	Gasket B	NBR	

Replacement Parts/Seal Kit

Bore size (mm)	Kit no.	Contents	Bore size (mm)	Kit no.	Contents
20	MGP20-Z-PS	Set of nos. above 18, 19, 20, 21	40	MGP40-Z-PS	Set of nos. above 18, 19, 20, 21
25	MGP25-Z-PS		50	MGP50-Z-PS	
32	MGP32-Z-PS		63	MGP63-Z-PS	

* Seal kit includes 18 to 21. Order the seal kit, based on each bore size.

* Since the seal kit does not include a grease pack, order it separately.

Grease pack part no.: GR-S-010 (10 g)

∅20 to ∅63/MGPWM

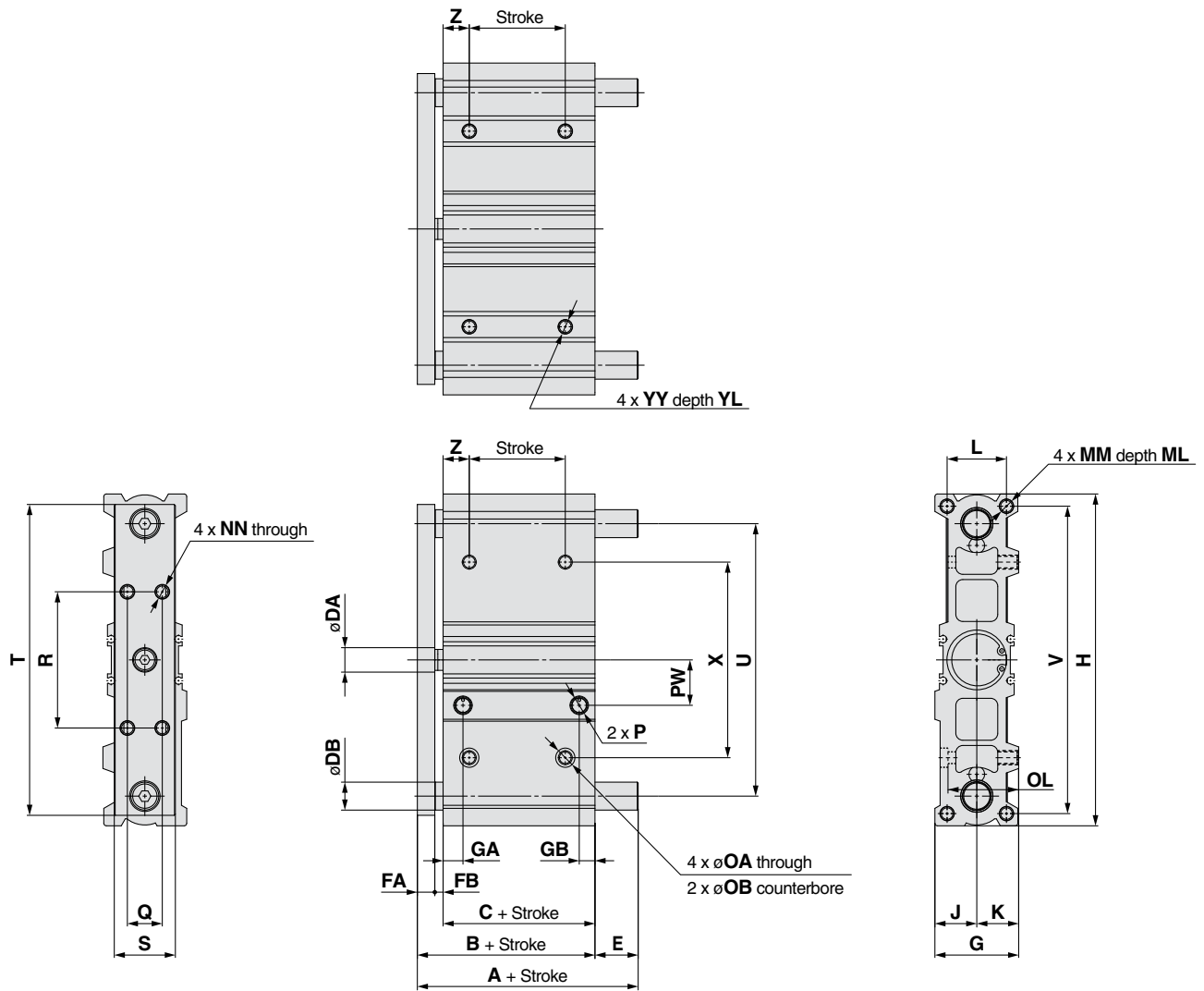

* For intermediate strokes other than standard strokes, refer to "Manufacture of Intermediate Strokes" on page 3.

MGPWM Common Dimensions

(mm)

Bore size (mm)	Standard stroke (mm)	A		B	C	DA	DB	E		FA	FB	G	GA	GB	H	J	K	L
		50 st or less	Over 50 stroke					50 st or less	Over 50 stroke									
20	25, 50, 75, 100, 125, 150, 175, 200	62	92	44.5	34	10	10	17.5	47.5	7.5	3	36	9.9	7.5	137	18	18	24
25		63.5	113.5	47	35	10	12	16.5	66.5	9	3	42	10.3	8.7	157	21	21	30
32		76.5	116.5	52	37	14	16	24.5	64.5	10	5	48	11.4	9	190	24	24	34
40		76.5	116.5	56	41	14	16	20.5	60.5	10	5	54	13.5	10.5	206	27	27	40
50		85	135	60.5	42	18	20	24.5	74.5	12.5	6	64	14	11.1	258	32	32	46
63		85	135	67.5	49	18	20	17.5	67.5	12.5	6	78	15.5	13.5	286	39	39	58

Bore size (mm)	MM	ML	NN	OA	OB	OL	P			PW	Q	R	S	T	U	V	X	YY	YL	Z
							Nil	TN	TF											
20	M5 x 0.8	13	M5 x 0.8	5.4	9.5	30.5	Rc1/8	NPT1/8	G1/8	17	14	64	24	123	108	126	76	M6 x 1	9	20
25	M6 x 1	15	M6 x 1	5.4	9.5	36.5	Rc1/8	NPT1/8	G1/8	18	16	68	26	146	128	146	92	M6 x 1	9	20
32	M8 x 1.25	20	M8 x 1.25	6.7	11	40.5	Rc1/8	NPT1/8	G1/8	26	20	78	35	178	156	176	112	M8 x 1.25	12	20
40	M8 x 1.25	20	M8 x 1.25	6.7	11	46.5	Rc1/8	NPT1/8	G1/8	27	20	92	35	193	172	192	128	M8 x 1.25	12	23
50	M10 x 1.5	22	M10 x 1.5	8.6	14	54.5	Rc1/4	NPT1/4	G1/4	28.5	26	132	44	247	220	240	168	M10 x 1.5	15	25
63	M10 x 1.5	22	M10 x 1.5	8.6	14	68.5	Rc1/4	NPT1/4	G1/4	30	30	160	48	274	248	266	196	M10 x 1.5	15	27

Series MGPW

Ø20 to Ø63/MGPWL, MGPWA

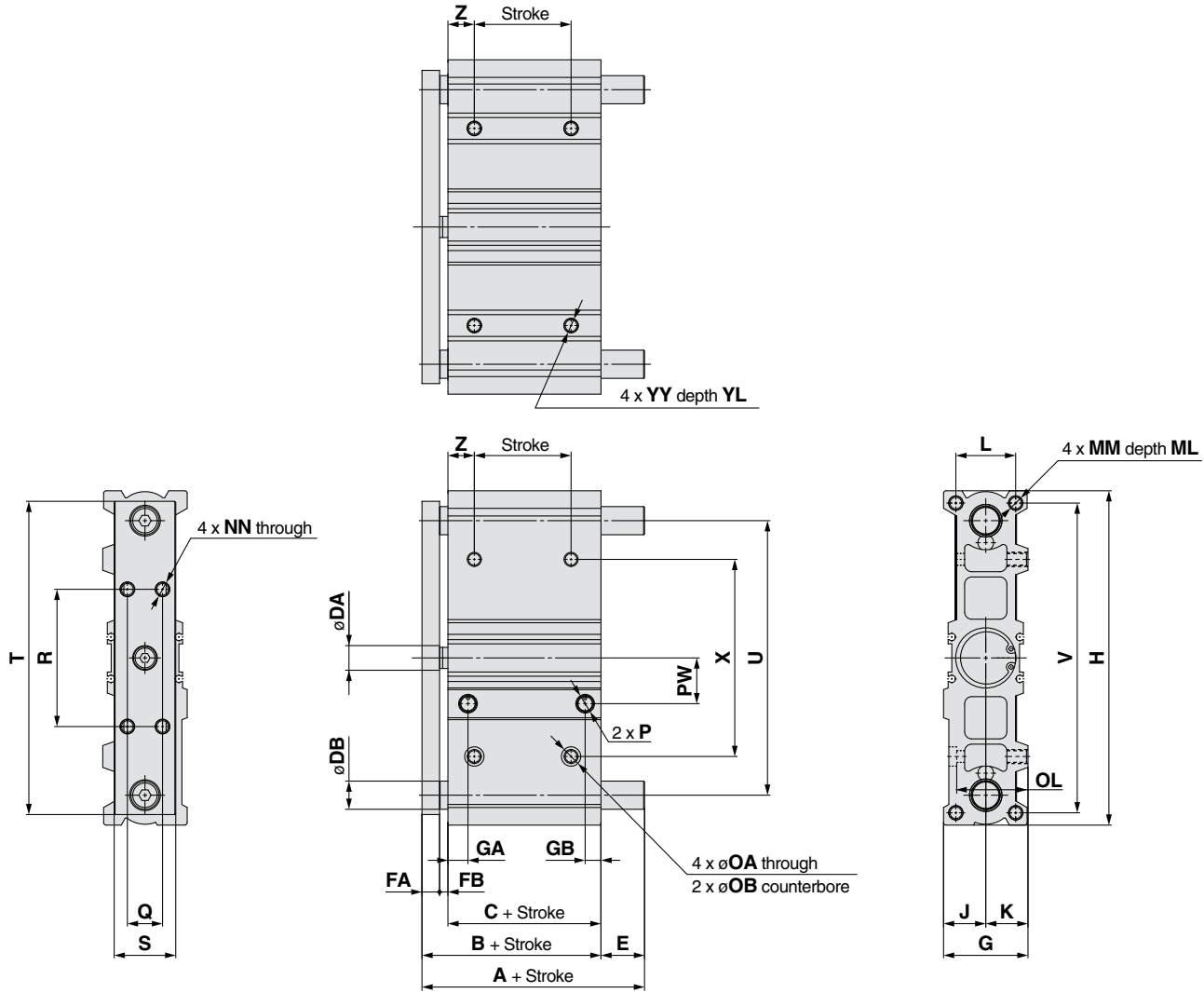

* For intermediate strokes other than standard strokes, refer to "Manufacture of Intermediate Strokes" on page 3.

MGPWL, MGPWA Common Dimensions

(mm)

Bore size (mm)	Standard stroke (mm)	B	C	DA	DB	FA	FB	G	GA	GB	H	J	K	L	MM	ML
20	25, 50, 75, 100, 125, 150, 175, 200	44.5	34	10	10	7.5	3	36	9.9	7.5	137	18	18	24	M5 x 0.8	13
25		47	35	10	13	9	3	42	10.3	8.7	157	21	21	30	M6 x 1	15
32		52	37	14	16	10	5	48	11.4	9	190	24	24	34	M8 x 1.25	20
40		56	41	14	16	10	5	54	13.5	10.5	206	27	27	40	M8 x 1.25	20
50		60.5	42	18	20	12.5	6	64	14	11.1	258	32	32	46	M10 x 1.5	22
63		67.5	49	18	20	12.5	6	78	15.5	13.5	286	39	39	58	M10 x 1.5	22

Bore size (mm)	NN	OA	OB	OL	P			PW	Q	R	S	T	U	V	X	YY	YL	Z
					Nil	TN	TF											
20	M5 x 0.8	5.4	9.5	30.5	Rc1/8	NPT1/8	G1/8	17	14	64	24	123	108	126	76	M6 x 1	9	20
25	M6 x 1	5.4	9.5	36.5	Rc1/8	NPT1/8	G1/8	18	16	68	26	146	128	146	92	M6 x 1	9	20
32	M8 x 1.25	6.7	11	40.5	Rc1/8	NPT1/8	G1/8	26	20	78	35	178	156	176	112	M8 x 1.25	12	20
40	M8 x 1.25	6.7	11	46.5	Rc1/8	NPT1/8	G1/8	27	20	92	35	193	172	192	128	M8 x 1.25	12	23
50	M10 x 1.5	8.6	14	54.5	Rc1/4	NPT1/4	G1/4	28.5	26	132	44	247	220	240	168	M10 x 1.5	15	25
63	M10 x 1.5	8.6	14	68.5	Rc1/4	NPT1/4	G1/4	30	30	160	48	274	248	266	196	M10 x 1.5	15	27

MGPWL, MGPWA Ø20, Ø25/A, E Dimensions

(mm)

Bore size (mm)	A			E		
	25 st or less	Over 25 st 100 st or less	Over 100 st	25 st or less	Over 25 st 100 st or less	Over 100 st
20	53.5	70.5	94.5	9	26	50
25	61.5	77.5	96.5	14.5	30.5	49.5

MGPWL, MGPWA Ø32 to Ø63/A, E Dimensions

(mm)

Bore size (mm)	A			E		
	50 st or less	Over 50 st 100 st or less	Over 100 st	50 st or less	Over 50 st 100 st or less	Over 100 st
32	72.5	89.5	109.5	20.5	37.5	57.5
40	72.5	89.5	109.5	16.5	33.5	53.5
50	82	103	123	21.5	42.5	62.5
63	82	103	123	14.5	35.5	55.5

Series MGPW

Auto Switch Mounting 1

Auto Switch Proper Mounting Position (Detection at Stroke End) and Its Mounting Height

- D-M9□
- D-M9□V
- D-M9□W
- D-M9□WV
- D-M9□A
- D-M9□AV
- D-A9□
- D-A9□V

ø20 to ø63

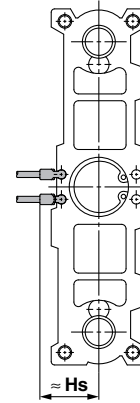
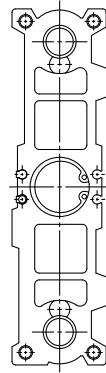
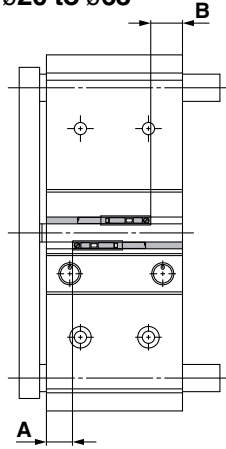

D-P3DW

ø32 to ø63

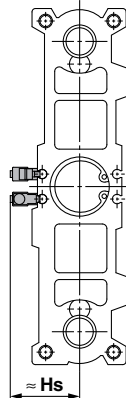
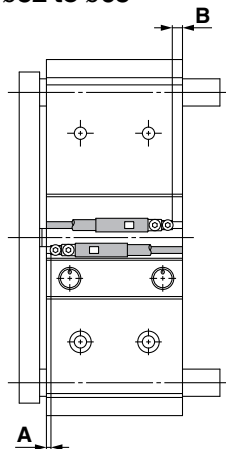

Auto Switch Proper Mounting Position Applicable Cylinder Series: MGPW

(mm)

Auto switch model Bore size (mm)	D-M9□ D-M9□V D-M9□W D-M9□WV D-M9□A D-M9□AV		D-A9□ D-A9□V		D-P3DW	
	A	B	A	B	A	B
20	11	11	7	7	—	—
25	10.5	12.5	6.5	8.5	—	—
32	12	13	8	9	7.5	8.5
40	14	15	10	11	9.5	10.5
50	13.5	16	9.5	12	9	11.5
63	16.5	20	12.5	16	12	15.5

Auto Switch Mounting Height

(mm)

Auto switch model Bore size (mm)	D-M9□V D-M9□WV D-M9□AV	D-A9□V	D-P3DW
	Hs	Hs	Hs
20	24.5	22	—
25	26	24	—
32	29	26.5	33
40	33	30.5	37
50	38.5	36	42.5
63	45.5	43	49.5

Note) Adjust the auto switch after confirming the operating conditions in the actual setting.

Auto Switch Mounting 2

Minimum Stroke for Auto Switch Mounting

		(mm)					
Auto switch model	No. of auto switches mounted	ø20	ø25	ø32	ø40	ø50	ø63
D-M9□	1 pc.	5 Note 1)		5			
	2 pcs.			10			
D-M9□W	1 pc.			5 Note 2)			
	2 pcs.			10			
D-M9□WV D-M9□AV	1 pc.			5 Note 2)			
	2 pcs.			10			
D-M9□A	1 pc.			5 Note 2)			
	2 pcs.			10 Note 2)			
D-M9□V	1 pc.			5			
	2 pcs.			5			
D-A9□V	1 pc.			5			
	2 pcs.			10			
D-A9□	1 pc.			5			
	2 pcs.			10			
D-P3DW	1 pc.	—		15			
	2 pcs.	—		15			

Note 1) Confirm that it is possible to secure the minimum bending radius of 10 mm of the auto switch lead wire before use.

Note 2) Confirm that it is possible to securely set the auto switch(es) within the range of indicator green light ON range before use.

For in-line entry type, please also consider Note 1) shown above.

Note 3) The D-P3DW can be mounted on bore sizes ø32 to ø63.

Other than the applicable auto switches listed in “How to Order”, the following auto switches are mountable.

Refer to pages 1719 to 1827 in Best Pneumatics No. 3 for detailed specifications.

Type	Model	Electrical entry	Features
Solid state switch	D-P4DW	Grommet (In-line)	Diagnostic indication (2-color display) Bore size: ø32 to ø63

* With pre-wired connector is also available for solid state auto switches. For details, refer to pages 1784 and 1785 in Best Pneumatics No. 3.

* Normally closed (NC = b contact) solid state auto switches (D-F9G/F9H) are also available. For details, refer to page 1746 in Best Pneumatics No. 3.

* When installing the D-P4DW, use the BMG7-032 auto switch mounting bracket.

Auto Switch Mounting Brackets/Part No.

Applicable Cylinder Series: MGPWM, MGPWL, MGPWA

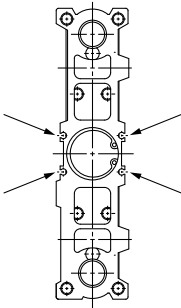
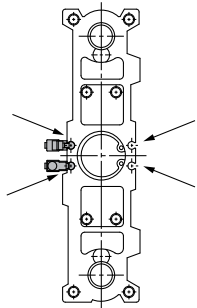
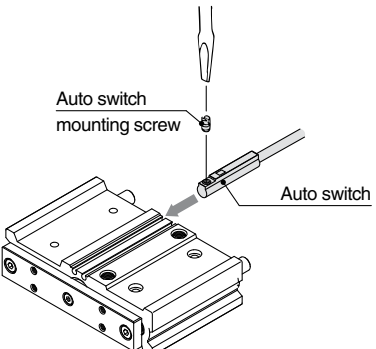
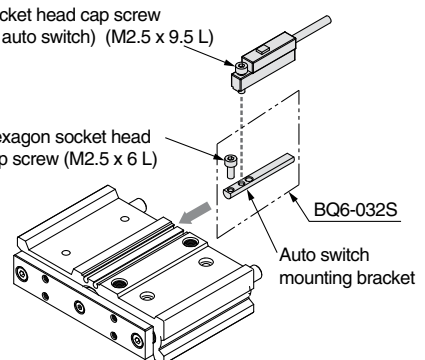
Applicable auto switches	D-M9□/M9□V D-M9□W/M9□WV D-M9□A/M9□AV D-A9□/A9□V	D-P3DW						
Bore size (mm)	ø20 to ø63	ø32 to ø63						
Auto switch mounting bracket part no.	—	BQ6-032S						
Auto switch mounting bracket fitting parts lineup/Weight	—	<ul style="list-style-type: none"> Hexagon socket head cap screw (M2.5 x 6 L) Auto switch mounting bracket (nut) Weight: 5 g 						
Auto switch mounting surfaces	Surfaces with auto switch mounting slot	Surfaces with auto switch mounting slot						
								
Mounting of auto switch	 <ul style="list-style-type: none"> When tightening the auto switch mounting screw, use a watchmakers' screwdriver with a handle 5 to 6 mm in diameter. <p style="text-align: center;">Tightening Torque for Auto Switch Mounting Screw</p> <table border="1" style="width: 100%; border-collapse: collapse;"> <thead> <tr> <th style="text-align: center;">Auto switch model</th> <th style="text-align: center;">Tightening torque</th> </tr> </thead> <tbody> <tr> <td style="text-align: center;">D-M9□(V) D-M9□W(V) D-M9□A(V)</td> <td style="text-align: center;">0.037 to 0.11 lbf-ft (0.05 to 0.15 N·m)</td> </tr> <tr> <td style="text-align: center;">D-A9□(V)</td> <td style="text-align: center;">0.074 to 0.15 lbf-ft (0.10 to 0.20 N·m)</td> </tr> </tbody> </table>	Auto switch model	Tightening torque	D-M9□(V) D-M9□W(V) D-M9□A(V)	0.037 to 0.11 lbf-ft (0.05 to 0.15 N·m)	D-A9□(V)	0.074 to 0.15 lbf-ft (0.10 to 0.20 N·m)	<ol style="list-style-type: none"> Fix the auto switch and the auto switch mounting bracket temporarily by tightening the attached hexagon socket head cap screw (M2.5 x 9.5 L) 1 to 2 turns. Insert the temporarily tightened mounting bracket into the mating groove of the cylinder tube, and slide the auto switch onto the cylinder tube through the groove. Check the detecting position of the auto switch and fix the auto switch firmly with the hexagon socket head cap screw (M2.5 x 6 L, M2.5 x 9.5 L).* If the detecting position is changed, go back to step ②. <p>* The hexagon socket head cap screw (M2.5 x 6 L) is used to fix the mounting bracket and cylinder tube. This enables the replacement of the auto switch without adjusting the auto switch position.</p> <p>Note 1) Ensure that the auto switch is covered with the mating groove to protect the auto switch.</p> <p>Note 2) The tightening torque for the hexagon socket head cap screw (M2.5 x 6 L, M2.5 x 9.5 L) is 0.15 to 0.22 lbf-ft (0.2 to 0.3 N·m).</p> <p>Note 3) Tighten the hexagon socket head cap screws evenly.</p> 
Auto switch model	Tightening torque							
D-M9□(V) D-M9□W(V) D-M9□A(V)	0.037 to 0.11 lbf-ft (0.05 to 0.15 N·m)							
D-A9□(V)	0.074 to 0.15 lbf-ft (0.10 to 0.20 N·m)							

Note) Auto switch mounting brackets and auto switches are enclosed with the cylinder for shipment.
 For an environment that needs the water-resistant auto switch, select the D-M9□A(V) type.

Prior to Use

Auto Switch Connection and Example

Sink Input Specifications

3-wire, NPN

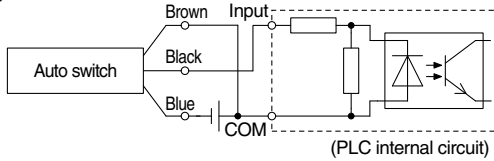

2-wire

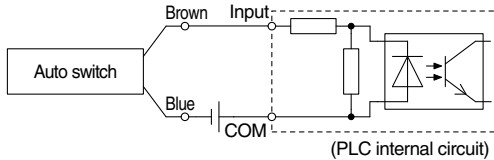

Source Input Specifications

3-wire, PNP

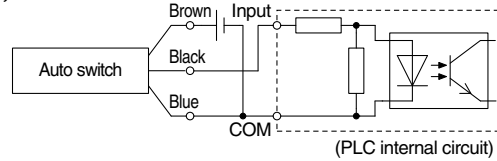

2-wire

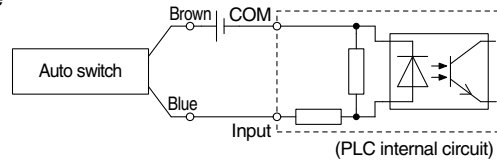

Connect according to the applicable PLC input specifications, as the connection method will vary depending on the PLC input specifications.

Example of AND (Series) and OR (Parallel) Connection

3-wire, AND connection for NPN output (Using relays)

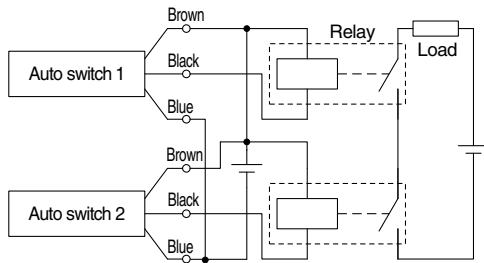

(Performed with auto switches only)

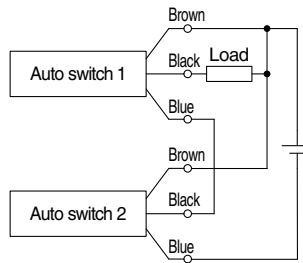

3-wire, OR connection for NPN output

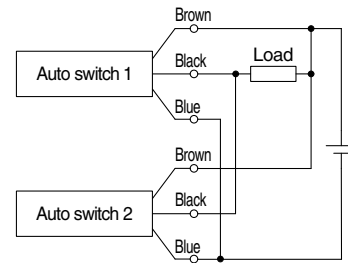

3-wire, AND connection for PNP output (Using relays)

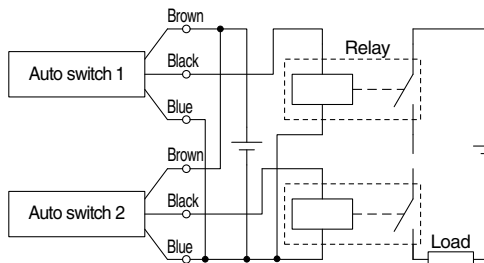

(Performed with auto switches only)

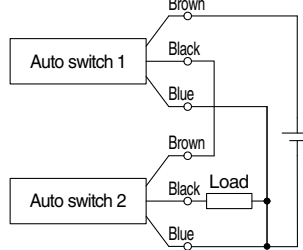

3-wire, OR connection for PNP output

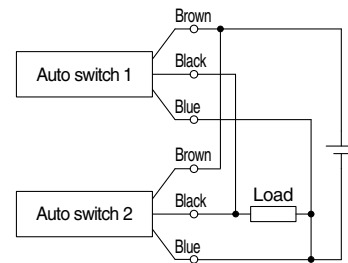

2-wire, AND connection

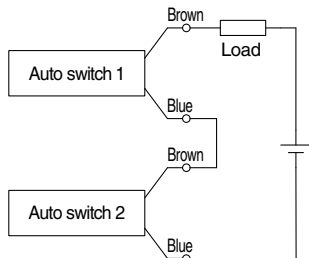

When two auto switches are connected in series, malfunction may occur because the load voltage will decrease in the ON state. The indicator lights will light up when both of the auto switches are in the ON state.

$$\begin{aligned} \text{Load voltage at ON} &= \text{Power supply voltage} - \text{Residual voltage} \times 2 \text{ pcs.} \\ &= 24 \text{ V} - 4 \text{ V} \times 2 \text{ pcs.} \\ &= 16 \text{ V} \end{aligned}$$

Example: Power supply voltage 24 VDC
Auto switch internal voltage drop 4 V

2-wire, OR connection

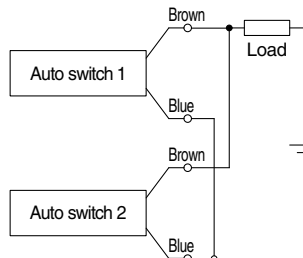

(Solid state)

When two auto switches are connected in parallel, malfunction may occur because the load voltage will increase in the OFF state.

$$\begin{aligned} \text{Load voltage at OFF} &= \text{Leakage current} \times 2 \text{ pcs.} \times \text{Load impedance} \\ &= 1 \text{ mA} \times 2 \text{ pcs.} \times 3 \text{ k}\Omega \\ &= 6 \text{ V} \end{aligned}$$

Example: Load impedance 3 kΩ
Auto switch leakage current 1 mA

(Reed)

Because there is no leakage current, the load voltage will not increase in the OFF state. However, depending on the number of auto switches in the ON state, the indicator lights may sometimes grow dim or not light up, due to the dispersion and reduction of the current flowing to the auto switches.

1 With Knock Pin Holes

Cylinder with knock positioning pin hole

How to Order

MGPW Standard model no. -XC56
 With knock pin holes

Specifications: Same as standard type

Dimensions (Dimensions other than below are the same as standard type.)

(mm)						
Bore size (mm)	HA	HB	N	RA	XA	XB
20	25 ±0.02	25 ±0.02	3 ^{H7} ₀ ^{+0.010} depth 6	28 ±0.02	17	76 ±0.03
25	28 ±0.02	28 ±0.02	4 ^{H7} ₀ ^{+0.012} depth 6	34 ±0.02	18	92 ±0.03
32	34 ±0.02	34 ±0.02	4 ^{H7} ₀ ^{+0.012} depth 6	42 ±0.02	19	112 ±0.03
40	38 ±0.02	38 ±0.02	4 ^{H7} ₀ ^{+0.012} depth 6	50 ±0.02	21	128 ±0.04
50	49 ±0.02	49 ±0.02	5 ^{H7} ₀ ^{+0.012} depth 8	65 ±0.03	21	168 ±0.04
63	58 ±0.03	58 ±0.03	5 ^{H7} ₀ ^{+0.012} depth 8	80 ±0.03	25	196 ±0.04

Top of the plate

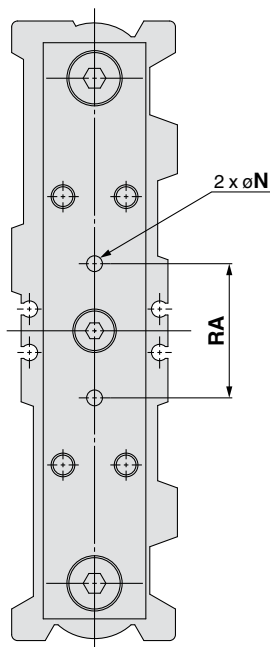

Side of the cylinder (Bottom)

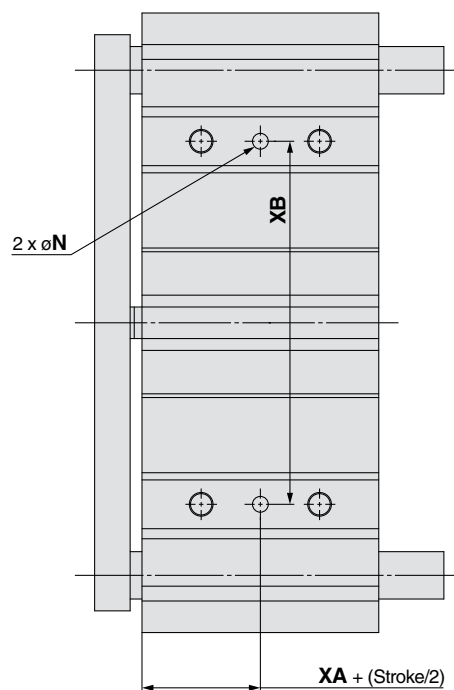

Bottom of the cylinder

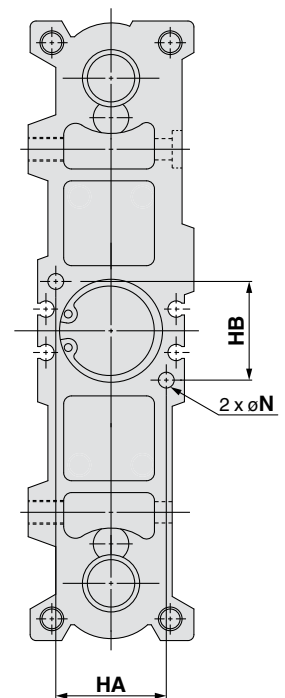

Series MGPW

Made to Order 2



Please contact SMC for detailed dimensions, specifications, and lead times.

2 Side Porting Type

Symbol
-X867

Ports are only on the top of the cylinder for the standard model, but side ports are also available.

How to Order

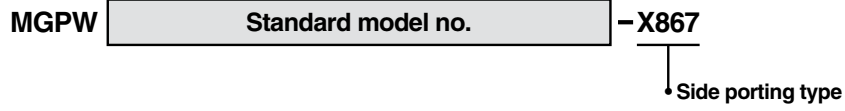

Port positions

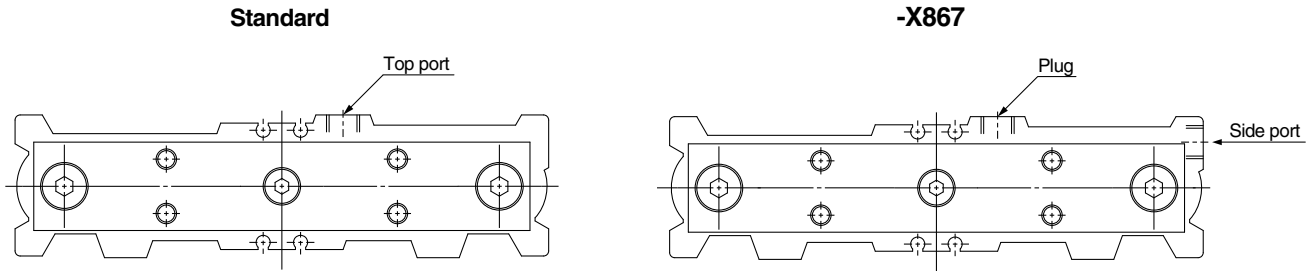

Specifications: Same as standard type

Dimensions (Dimensions other than below are the same as standard type.)

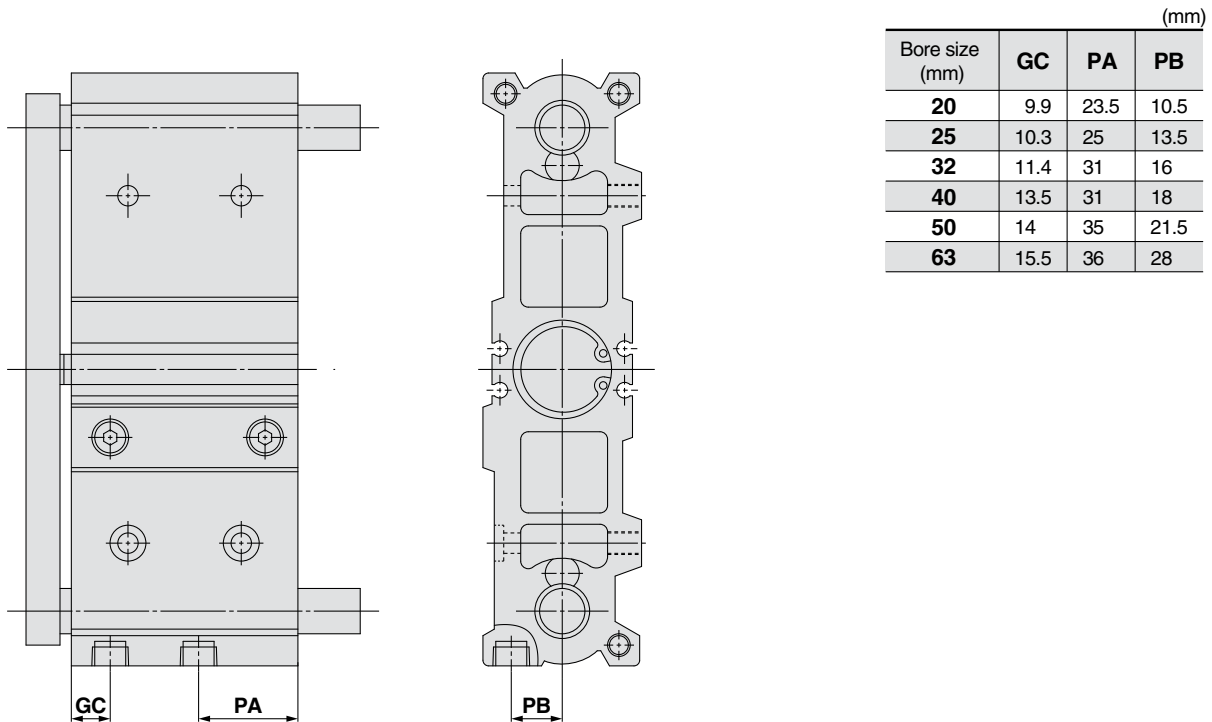

Safety Instructions

These safety instructions are intended to prevent hazardous situations and/or equipment damage. These instructions indicate the level of potential hazard with the labels of “Caution,” “Warning” or “Danger.” They are all important notes for safety and must be followed in addition to International Standards (ISO/IEC)*1, and other safety regulations.

 **Caution:** **Caution** indicates a hazard with a low level of risk which, if not avoided, could result in minor or moderate injury.

 **Warning:** **Warning** indicates a hazard with a medium level of risk which, if not avoided, could result in death or serious injury.

 **Danger:** **Danger** indicates a hazard with a high level of risk which, if not avoided, will result in death or serious injury.

*1) ISO 4414: Pneumatic fluid power – General rules relating to systems.
ISO 4413: Hydraulic fluid power – General rules relating to systems.
IEC 60204-1: Safety of machinery – Electrical equipment of machines.
(Part 1: General requirements)
ISO 10218-1: Manipulating industrial robots - Safety.
etc.

Warning

1. The compatibility of the product is the responsibility of the person who designs the equipment or decides its specifications.

Since the product specified here is used under various operating conditions, its compatibility with specific equipment must be decided by the person who designs the equipment or decides its specifications based on necessary analysis and test results. The expected performance and safety assurance of the equipment will be the responsibility of the person who has determined its compatibility with the product. This person should also continuously review all specifications of the product referring to its latest catalog information, with a view to giving due consideration to any possibility of equipment failure when configuring the equipment.

2. Only personnel with appropriate training should operate machinery and equipment.

The product specified here may become unsafe if handled incorrectly. The assembly, operation and maintenance of machines or equipment including our products must be performed by an operator who is appropriately trained and experienced.

3. Do not service or attempt to remove product and machinery/equipment until safety is confirmed.

1. The inspection and maintenance of machinery/equipment should only be performed after measures to prevent falling or runaway of the driven objects have been confirmed.
2. When the product is to be removed, confirm that the safety measures as mentioned above are implemented and the power from any appropriate source is cut, and read and understand the specific product precautions of all relevant products carefully.
3. Before machinery/equipment is restarted, take measures to prevent unexpected operation and malfunction.

4. Contact SMC beforehand and take special consideration of safety measures if the product is to be used in any of the following conditions.

1. Conditions and environments outside of the given specifications, or use outdoors or in a place exposed to direct sunlight.
2. Installation on equipment in conjunction with atomic energy, railways, air navigation, space, shipping, vehicles, military, medical treatment, combustion and recreation, or equipment in contact with food and beverages, emergency stop circuits, clutch and brake circuits in press applications, safety equipment or other applications unsuitable for the standard specifications described in the product catalog.
3. An application which could have negative effects on people, property, or animals requiring special safety analysis.
4. Use in an interlock circuit, which requires the provision of double interlock for possible failure by using a mechanical protective function, and periodical checks to confirm proper operation.

Caution

1. The product is provided for use in manufacturing industries.

The product herein described is basically provided for peaceful use in manufacturing industries.

If considering using the product in other industries, consult SMC beforehand and exchange specifications or a contract if necessary.

If anything is unclear, contact your nearest sales branch.

Limited warranty and Disclaimer/ Compliance Requirements

The product used is subject to the following “Limited warranty and Disclaimer” and “Compliance Requirements”.

Read and accept them before using the product.

Limited warranty and Disclaimer

1. The warranty period of the product is 1 year in service or 1.5 years after the product is delivered, whichever is first.*2)
Also, the product may have specified durability, running distance or replacement parts. Please consult your nearest sales branch.
2. For any failure or damage reported within the warranty period which is clearly our responsibility, a replacement product or necessary parts will be provided.
This limited warranty applies only to our product independently, and not to any other damage incurred due to the failure of the product.
3. Prior to using SMC products, please read and understand the warranty terms and disclaimers noted in the specified catalog for the particular products.

*2) Vacuum pads are excluded from this 1 year warranty.

A vacuum pad is a consumable part, so it is warranted for a year after it is delivered. Also, even within the warranty period, the wear of a product due to the use of the vacuum pad or failure due to the deterioration of rubber material are not covered by the limited warranty.

Compliance Requirements

1. The use of SMC products with production equipment for the manufacture of weapons of mass destruction (WMD) or any other weapon is strictly prohibited.
2. The exports of SMC products or technology from one country to another are governed by the relevant security laws and regulations of the countries involved in the transaction. Prior to the shipment of a SMC product to another country, assure that all local rules governing that export are known and followed.

Safety Instructions

Be sure to read “Handling Precautions for SMC Products” (M-E03-3) before using.

Global Manufacturing, Distribution and Service Network

Worldwide Subsidiaries

North & South America

- U.S.A. SMC Corporation of America
- CANADA SMC Pneumatics (Canada) Ltd.
- MEXICO SMC Corporation (México), S.A. de C.V.
- BRAZIL SMC Pneumáticos do Brasil Ltda.
- CHILE SMC Pneumatics (Chile) S.A.
- COLOMBIA SMC Colombia Sucursal de SMC Chile S.A.
- ARGENTINA SMC Argentina S.A.
- BOLIVIA SMC Pneumatics Bolivia S.r.l.
- VENEZUELA SMC Neumatica Venezuela S.A.
- PERU (Distributor) IMPECO Automatización Industrial S.A.C.
- ECUADOR (Distributor) ASISTECH CIA. LTDA.

Asia/Oceania

- CHINA SMC(China)Co.,Ltd.
- CHINA SMC Pneumatics (Guangzhou) Ltd.
- HONG KONG SMC Pneumatics(Hong Kong)Ltd.
- TAIWAN SMC Pneumatics(Taiwan)Co.,Ltd.
- KOREA SMC Pneumatics Korea Co., Ltd.
- SINGAPORE SMC Pneumatics(S.E.A.)Pte.Ltd.
- MALAYSIA SMC Pneumatics(S.E.A.)Sdn.Bhd.
- THAILAND SMC (Thailand) Ltd.
- PHILIPPINES Shoketsu SMC Corporation
- INDIA SMC Pneumatics(India)Pvt.Ltd.
- ISRAEL (Distributor) Baccara Geva A.C.S. Ltd.
- INDONESIA (Distributor) PT. Sinar Mutiara Cemerlang
- VIETNAM (Distributor) Dy Dan Trading Co.,Ltd.
- PAKISTAN (Distributor) Jubilee Corporation

Asia/Oceania

- SRI LANKA (Distributor) Electro-Serv(Pvt.)Ltd.
- IRAN (Distributor) Abzarchian Co. Ltd.
- U.A.E. (Distributor) Machinery People Trading Co. L.L.C.
- KUWAIT (Distributor) Esco Kuwait Equip & Petroleum App. Est.
- SAUDI ARABIA (Distributor) Assaggaff Trading Est.
- BAHRAIN (Distributor) Mohammed Jalal & Sons W.L.L. Technical & Automotive Services
- SYRIA (Distributor) Miak Corporation
- JORDAN (Distributor) Atafawok Trading Est.
- BANGLADESH (Distributor) Chemie International
- AUSTRALIA SMC Pneumatics(Australia)Pty.Ltd.
- NEW ZEALAND SMC Pneumatics(N.Z.)Ltd.
- JAPAN SMC Corporation

Europe/Africa

- GERMANY SMC Pneumatik GmbH
- SWITZERLAND SMC Pneumatik AG
- U.K. SMC Pneumatics (U.K.) Ltd.
- FRANCE SMC Pneumatique SA
- SPAIN / PORTUGAL SMC España S.A.
- ITALY SMC Italia S.p.A.
- GREECE SMC HELLAS E.P.E
- IRELAND SMC Pneumatics (Ireland) Ltd.
- NETHERLANDS (Associated company) SMC Pneumatics BV
- BELGIUM (Associated company) SMC Pneumatics N.V./S.A.
- DENMARK SMC Pneumatik A/S
- AUSTRIA SMC Pneumatik GmbH (Austria)

Europe/Africa

- CZECH REPUBLIC SMC Industrial Automation CZ s.r.o.
- HUNGARY SMC Hungary Ipari Automatizálási Kft.
- POLAND SMC Industrial Automation Polska Sp. z o.o.
- SLOVAKIA SMC Priemyselná Automatizácia Spol s.r.o.
- SLOVENIA SMC Industrijska Avtomatika d.o.o.
- BULGARIA SMC Industrial Automation Bulgaria EOOD
- CROATIA SMC Industrijska Avtomatika d.o.o.
- BOSNIA AND HERZEGOVINA(Distributor) A.M. Pneumatik d.o.o.
- SERBIA(Distributor) Best Pneumatics d.o.o.
- UKRAINE(Distributor) PNEUMOTEC Corp.
- FINLAND SMC Pneumatics Finland Oy
- NORWAY SMC Pneumatics Norway AS
- SWEDEN SMC Pneumatics Sweden AB
- ESTONIA SMC Pneumatics Estonia Oü
- LATVIA SMC Pneumatics Latvia SIA
- LITHUANIA(LIETUVA) UAB "SMC Pneumatics"
- ROMANIA SMC Romania S.r.l.
- RUSSIA SMC Pneumatik LLC.
- KAZAKHSTAN SMC Kazakhstan, LLC.
- TURKEY (Distributor) Entek Pnömatik Sanayi ve Ticaret Şirketi
- MOROCCO (Distributor) Soraflex
- TUNISIA (Distributor) Bymis
- EGYPT (Distributor) Saadani Trading & Industrial Services
- NIGERIA (Distributor) Faraday Engineering Company Ltd.
- SOUTH AFRICA (Distributor) Hyflo Southern Africa (Pty.) Ltd.

U.S. & Canadian Sales Offices

WEST

- Austin
- Dallas
- Los Angeles
- Phoenix
- Portland
- San Francisco
- Vancouver

EAST

- Atlanta
- Birmingham
- Boston
- Charlotte
- Nashville
- New Jersey
- Richmond
- Rochester
- Tampa
- Montreal

CENTRAL

- Chicago
- Cincinnati
- Cleveland
- Detroit
- Indianapolis
- Milwaukee
- Minneapolis
- St. Louis
- Toronto
- Windsor

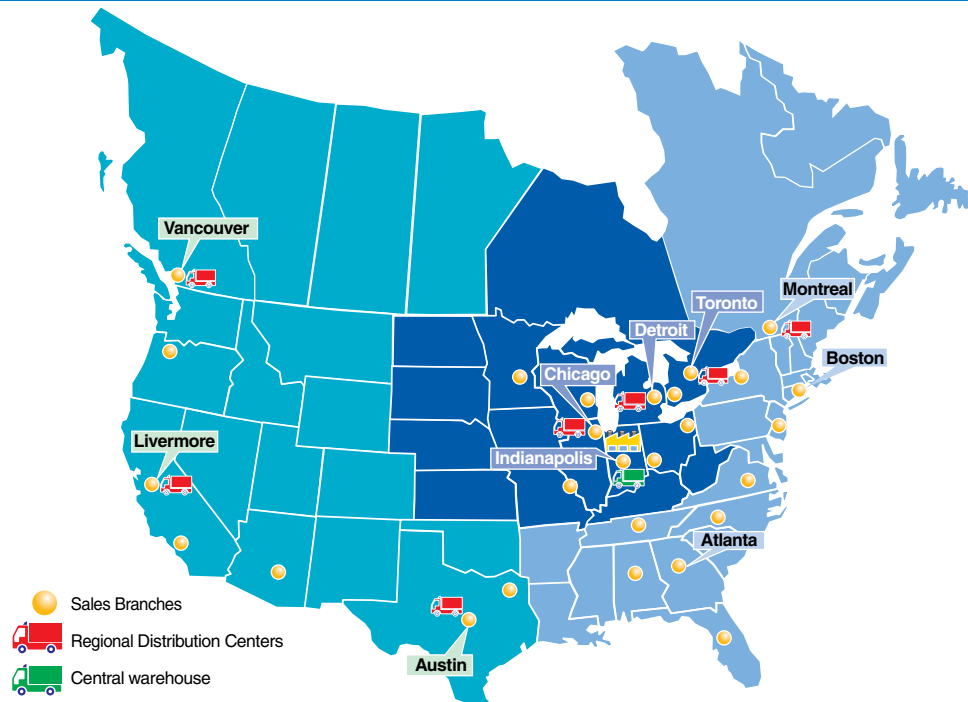

SMC Corporation of America
10100 SMC Blvd., Noblesville, IN 46060

www.smcusa.com
SMC Pneumatics (Canada) Ltd.
www.smc Pneumatics.ca

(800) SMC.SMC1 (762-7621)
e-mail: sales@smcusa.com
For International inquiries: www.smcworld.com