

LQW15AN22NJ00#

" # " indicates a package specification code.



< List of part numbers with package codes >
LQW15AN22NJ00D , LQW15AN22NJ00B

Shape

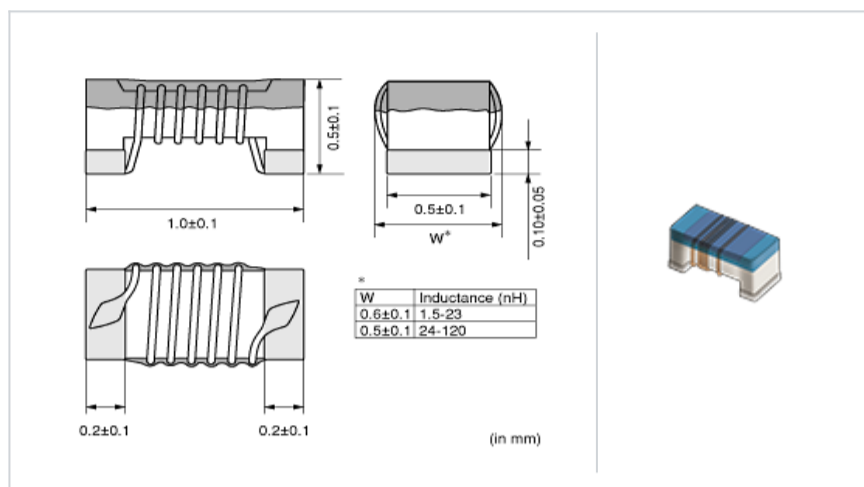

L size	1.0 ± 0.1mm
W size	0.6 ± 0.1mm
T size	0.5 ± 0.1mm
Size code in inch (mm)	0402 (1005)

Specifications

Inductance	22nH ± 5%
Inductance test frequency	100MHz
Rated current (Itemp) (Based on Temperature rise)	310mA
Max. of DC resistance	0.30
Q (min.)	25
Q test frequency	250MHz
Self resonance frequency (min.)	4.0GHz
Operating temperature range (Self-temperature rise is not included)	-55 ~ 125

References

Packaging code	Specifications	Minimum quantity
D	180mm Paper taping	10000
B	Packing in bulk	500

Mass (Typ.)	
1 piece	0.0008g

⚠ Attention

- 1.This datasheet is downloaded from the website of Murata Manufacturing Co., Ltd. Therefore, it ' s specifications are subject to change or our products in it may be discontinued without advance notice. Please check with our sales representatives or product engineers before ordering.
- 2.This datasheet has only typical specifications because there is no space for detailed specifications. Therefore, please review our product specifications or consult the approval sheet for product specifications before ordering.

▪ Inductance-Frequency characteristics (Typ.)

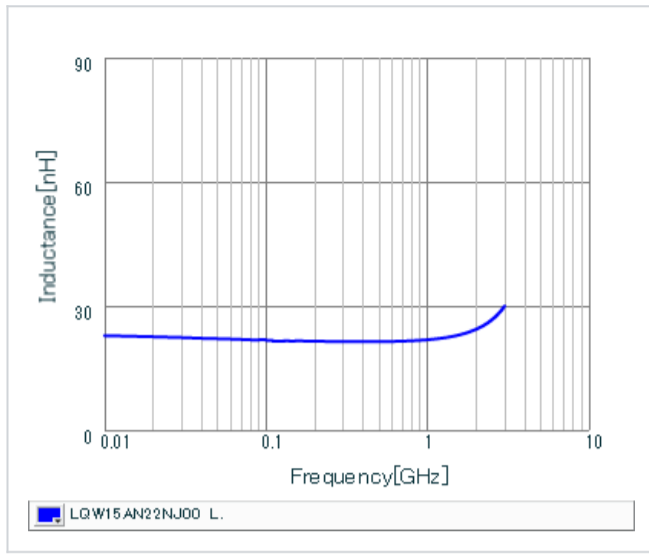

▪ Q-Frequency characteristics (Typ.)

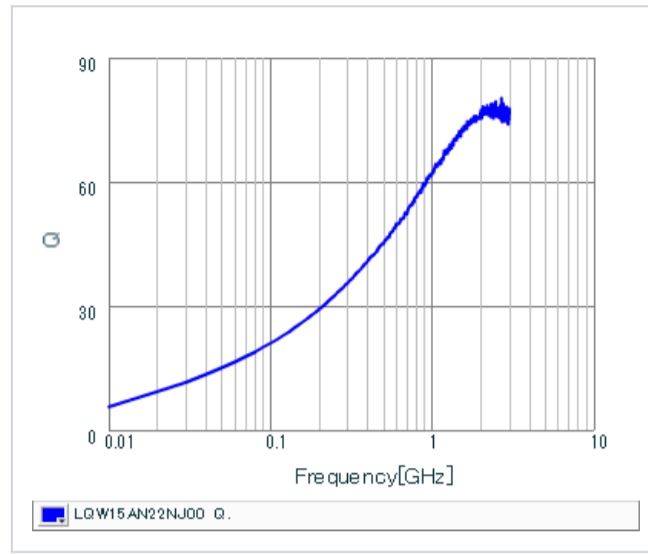

This PDF data has only typical specifications because there is no space for detailed specifications. Therefore, please review our product specifications or consult the approval sheet for product specifications before ordering.