

# LQW15AN1N8C00#

“#” indicates a package specification code.

Size Code 1005 (0402) in mm (in inch), High Q, Low DC Resistance Type



< List of part numbers with package codes >

LQW15AN1N8C00B LQW15AN1N8C00D

## Appearance & Shape

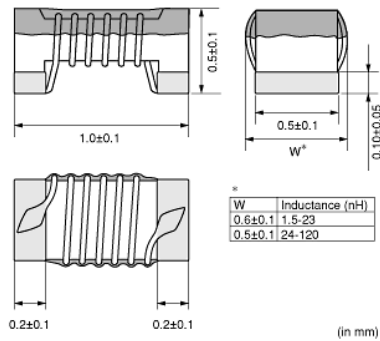
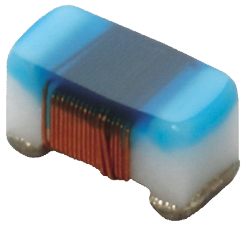

## References

Packaging	Specifications	Minimum Order Quantity
B	Bulk(Bag)	500
D	180mm Paper Tape	10000

Mass (typ.)	
1 piece	0.0008g

### Attention

1.This datasheet is downloaded from the website of Murata Manufacturing Co., Ltd. Therefore, it's specifications are subject to change or our products in it may be discontinued without advance notice. Please check with our sales representatives or product engineers before ordering.

2.This datasheet has only typical specifications because there is no space for detailed specifications.

Therefore, please review our product specifications or consult the approval sheet for product specifications before ordering.

# LQW15AN1N8C00#

“#” indicates a package specification code.

## Specifications

L size	1.0±0.1mm
W size	0.6±0.1mm
T size	0.5±0.1mm
Size code inch (mm)	0402 (1005)
Inductance	1.8nH±0.2nH
Inductance Test Frequency	100MHz
Rated current (Itemp) (Based on Temperature rise)	460mA
Max. of DC resistance	0.16Ω
Q(min.)	10
Q Test Frequency	250MHz
Self resonance frequency (min.)	16GHz
Operating Temperature Range(Self-temperature rise is not included)	-55°C to 125°C
Series	LQW15AN_00

### Attention

1.This datasheet is downloaded from the website of Murata Manufacturing Co., Ltd. Therefore, it's specifications are subject to change or our products in it may be discontinued without advance notice. Please check with our sales representatives or product engineers before ordering.

2.This datasheet has only typical specifications because there is no space for detailed specifications.

Therefore, please review our product specifications or consult the approval sheet for product specifications before ordering.

# LQW15AN1N8C00#

"#" indicates a package specification code.

## Characteristic Data

The charts below may show another part number which shares its characteristics.

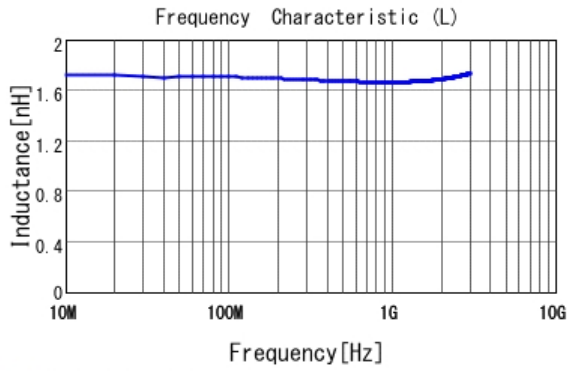

■ LQW15AN1N8C00 L

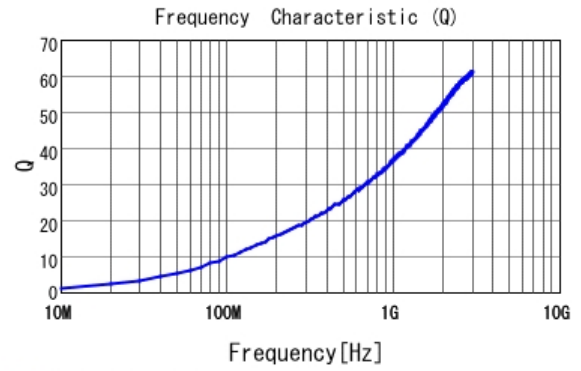

■ LQW15AN1N8C00 Q

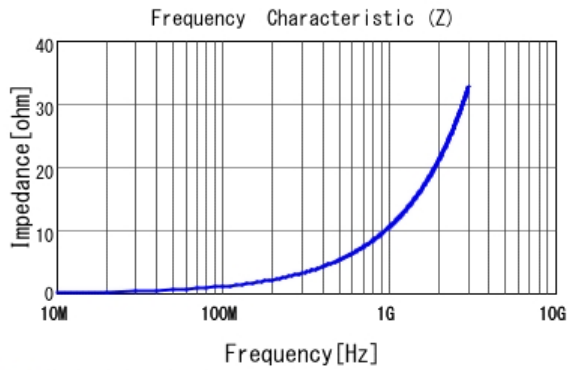

■ LQW15AN1N8C00 |Z|

**Attention**

- 1.This datasheet is downloaded from the website of Murata Manufacturing Co., Ltd. Therefore, it's specifications are subject to change or our products in it may be discontinued without advance notice. Please check with our sales representatives or product engineers before ordering.
- 2.This datasheet has only typical specifications because there is no space for detailed specifications.  
Therefore, please review our product specifications or consult the approval sheet for product specifications before ordering.