



EN Operating instructions. pages 1 to 10
Original

7 Wiring examples
7.1 Possible applications 6
7.2 Application example. 6
7.3 Start configuration 7
7.4 Feedback circuit. 7
7.5 Release signal SRB-E-201. 7
7.6 Sensor configuration 8

8 Set-up and maintenance
8.1 Commissioning 8
8.2 Functional testing. 8
8.3 Behaviour in the case of faults. 9
8.4 Setting report. 9
8.5 Maintenance 9

9 Disassembly and disposal
9.1 Disassembly. 9
9.2 Disposal 9

10 Appendix
10.1 Wiring/circuit information. 9

11 EU Declaration of conformity

Content

1 About this document
1.1 Function 1
1.2 Target group: authorised qualified personnel. 1
1.3 Explanation of the symbols used 1
1.4 Appropriate use 2
1.5 General safety instructions 2
1.6 Warning about misuse 2
1.7 Exclusion of liability 2

2 Product description
2.1 Ordering code 2
2.2 Special versions. 2
2.3 Purpose 2
2.4 Technical data 2
2.5 Derating / electrical lifespan of safety contacts 3
2.6 Safety classification 3

3 Mounting
3.1 General mounting instructions 4
3.2 Dimensions 4

4 Electrical connection
4.1 General information for electrical connection. 4
4.2 Coding of connecting terminals 4

5 Operating principle and settings
5.1 Description of the terminals and LED indications 4
5.2 Adjustable applications 5
5.3 Changing setting or application 5

6 Diagnostic
6.1 LED indications 6
6.2 Malfunctions. 6

1. About this document

1.1 Function
This operating instructions manual provides all the information you need for the mounting, set-up and commissioning to ensure the safe operation and disassembly of the safety-monitoring module. The operating instructions must be available in a legible condition and a complete version in the vicinity of the device.

1.2 Target group: authorised qualified personnel
All operations described in this operating instructions manual must be carried out by trained specialist personnel, authorised by the plant operator only.

Please make sure that you have read and understood these operating instructions and that you know all applicable legislations regarding occupational safety and accident prevention prior to installation and putting the component into operation.

The machine builder must carefully select the harmonised standards to be complied with as well as other technical specifications for the selection, mounting and integration of the components.

1.3 Explanation of the symbols used

 **Information, hint, note:**
This symbol is used for identifying useful additional information.

 **Caution:** Failure to comply with this warning notice could lead to failures or malfunctions.
Warning: Failure to comply with this warning notice could lead to physical injury and/or damage to the machine.

 **Changed ambient temperature SRB-E-301ST:**
-25 °C ... +50 °C

1.4 Appropriate use

The products described in these operating instructions are developed to execute safety-related functions as part of an entire plant or machine. It is the responsibility of the manufacturer of a machine or plant to ensure the correct functionality of the entire machine or plant.

The safety-monitoring module must be exclusively used in accordance with the versions listed below or for the applications authorised by the manufacturer. Detailed information regarding the range of applications can be found in the chapter "Product description".

1.5 General safety instructions

The user must observe the safety instructions in this operating instructions manual, the country specific installation standards as well as all prevailing safety regulations and accident prevention rules.



Further technical information can be found in the Schmersal catalogues or in the online catalogue on the Internet: products.schmersal.com.

The information contained in this operating instructions manual is provided without liability and is subject to technical modifications.



The entire concept of the control system, in which the safety component is integrated, must be validated to ISO 13849-2.

There are no residual risks, provided that the safety instructions as well as the instructions regarding mounting, commissioning, operation and maintenance are observed.

1.6 Warning about misuse



In case of inadequate or improper use or manipulations of the safety-monitoring module, personal hazards or damage to machinery or plant components cannot be excluded. The relevant requirements of the standards EN ISO 14119 and EN ISO 13850 must be observed.



ISO 13856-1:

1. Range of application (compendium)

This part of EN ISO 13856-1 is applicable to pressure-sensitive mats and pressure-sensitive floors, regardless of the type of energy used (e.g. electrical, hydraulic, pneumatic or mechanical), designed to detect

- persons weighing more than 35 kg, and
- persons (e.g. children) weighing more than 20 kg.

It is not applicable to detect persons weighing less than 20 kg.

1.7 Exclusion of liability

We shall accept no liability for damages and malfunctions resulting from defective mounting or failure to comply with this operating instructions manual. The manufacturer shall accept no liability for damages resulting from the use of unauthorised spare parts or accessories.

For safety reasons, invasive work on the device as well as arbitrary repairs, conversions and modifications to the device are strictly forbidden, the manufacturer shall accept no liability for damages resulting from such invasive work, arbitrary repairs, conversions and/or modifications to the device.

The safety relay module is to be operated in an area in which access by personnel is restricted.

2. Product description

2.1 Ordering code

This operating instructions manual applies to the following types:

SRB-E-201ST-①

SRB-E-201LC-①

SRB-E-301ST-①

No.	Option	Description
①	CC	Plug-in screw clamps: single wire (rigid) or fine wire (flexible): 0.2 ... 2.5 mm ² ; fine wire with ferrule: 0.25 ... 2.5 mm ² Plug-in cage clamps: single wire (rigid) or fine wire (flexible): 0.2 ... 1.5 mm ² ; fine wire with ferrule: 0.25 ... 1.5 mm ²



Only if the action described in these operating instructions is carried out correctly will the safety function be safeguarded, including compliance with the Machinery Directive.

2.2 Special versions

For special versions, which are not listed in the order code below 2.1, these specifications apply accordingly, provided that they correspond to the standard version.

2.3 Purpose

The safety-monitoring modules for integration in safety circuits are designed for fitting in control cabinets. They are used for the safe evaluation of the signals of positive break position switches for safety functions or safety sensors for safety functions on sliding, hinged and removable safety guards as well as emergency stop control devices, safety mats, magnetic safety switches and AOPDs.

The safety function is defined as the switch-off of outputs Q1, Q2 and 13/14, 23/24, 33/34 with the opening of inputs S12 and/or S22 or with safety mats through a short-circuit between inputs S12 and S22. Taking account of a PFH value assessment, the safety-relevant current paths meet the following requirements (see also chapter 2.6 "Safety classification"):

- Control category 4 - PL e to ISO 13849-1
- SIL 3 to IEC 61508
- SILCL 3 to IEC 62061

To determine the Performance Level (PL) to ISO 13849-1 of the entire safety function (e.g. sensor, logic, actuator), an assessment of all relevant components is required.

2.4 Technical data

General data

Standards:	EN 60204-1, EN 60947-5-1; ISO 13849-1, IEC 62061, IEC 61508
EMC rating:	to EMC Directive
Air clearances and creepage distances:	to EN 60664-1
Mounting:	standard rail to EN 60715
Terminal designations:	EN 60947-1

Electrical characteristics:

Rated operating voltage U _e :	24 VDC -20%/+20%, residual ripple max. 10%
- SRB-E-201ST/LC:	24 VDC / 24 VAC -20%/+20%
- SRB-E-301ST:	50 Hz/60 Hz
Frequency range SRB-E-301ST:	SELV power supply to EN 60950; safety transformer to EN 61558-2-6 (AC); mains power supply must harmonise with device safety (characteristic/melting property) so that triggering is assured.

Power consumption:

- SRB-E-201ST/LC:	2.4 W (+ load of the safety outputs)
- SRB-E-301ST:	3 W, 4 VA

Operating instructions

Safety relay module

SRB-E-201ST / SRB-E-201LC / SRB-E-301ST

Fuse rating for the operating voltage:	we recommend a circuit breaker type Z (max. 16 A) or a fine fuse (max. 15 A, delayed action)
UL Rating of external fuse:	max. 16 A, only use fuses in accordance with UL 248 series
Insulation values to IEC 60664-1:	
Rated insulation voltage U_i :	
- safety contacts:	250 V
- safety outputs:	50V
Rated impulse withstand voltage U_{imp} :	
- safety contacts 13-14, 23-24:	6 kV
- safety contact 33-34:	4 kV
- safety outputs:	0.8 kV
Overvoltage category:	III
Degree of pollution:	2
Pull-in delay:	< 150 ms
Drop-out delay in case of "emergency stop":	< 10 ms
Drop-out delay on "supply failure":	< 10 ms
Drop-out delay in case of safety mats SMS:	< 100 ms
Bridging in case of voltage drops:	typ. 5 ms
Readiness after switching on voltage [s]:	< 1.5 sec.
Control current circuits/inputs:	
Inputs S12, S22:	24 VDC/8 mA
Inputs X2, X3, X7:	24 VDC/8 mA
Clock outputs S11, S21:	> 20 VDC, 10 mA per output
Cable length:	1500 m with 1.5 mm ² ; 2500 m with 2.5 mm ²
Conduction resistance:	max. 40 Ω
Relay outputs:	
Switching capacity of the safety contacts:	
- SRB-E-301ST:	contacts 13-14, 23-24, 33-34: max. 250 V, 6 A ohms, min. 10 VDC / 10 mA (Derating see 2.5)
Fuse rating of the safety contacts:	external ($I_k = 1000$ A) to EN 60947-5-1 Safety fuse 10 A quick blow, 6 A slow blow
Utilisation category to EN 60947-5-1:	AC-15: 230 V / 4 A DC-13: 24 V / 4 A
Switching capacity of the auxiliary contacts:	41-42: 24 VDC / 1 A
Fuse rating for the auxiliary contact:	safety fuse 2.5 A quick blow, 2 A slow blow
Electrical life:	refer to 2.5
Mechanical life:	10 million operations
Safety contact values:	resistance max. 100 m Ω , AgNi, self-cleaning, positive action
Semi-conductor outputs:	
Switching capacity of the safety outputs Q:	
- SRB-E-201ST:	max. 5.5 A
- SRB-E-201LC:	max. 2 A
Voltage drop:	< 0.5 V
Leakage current:	< 1 mA
Max. fuse rating of the safety outputs:	refer to "Operating voltage"
Test impulse to Q1, Q2:	< 1 ms (negative) < 100 μ s (positive)
Utilisation category as per EN 60947-5-1:	
- SRB-E-201ST:	DC-13: 24 V / 3.5 A
- SRB-E-201LC:	DC-13: 24 V / 2 A
Switching capacity of signaling outputs:	semi-conductor output Y1: 24 VDC/100 mA
Fuse rating of the signalling outputs:	internal electronic trip, tripping current > 100 mA
Max. switching cycles / minute:	
- SRB-E-201ST/LC:	60
- SRB-E-301ST:	20
Inductive consumers:	provision is to be made for suitable protective wiring for suppression
Mechanical data:	
Connection type:	refer to 2.1
Cable section:	refer to 2.1
Connecting cable:	rigid or flexible
Tightening torque for the terminals:	0.5 Nm
Material of enclosure:	glass-fibre reinforced thermoplastic, ventilated

Weight:	
- SRB-E-201ST/LC:	130 g
- SRB-E-301ST:	175 g
Ambient conditions:	
Ambient temperature:	-25°C ... +60°C
- SRB-E-301ST:	-25°C ... +50°C (non condensing)
Storage and transport temperature:	-40°C ... +85°C (non condensing)
Protection class:	Enclosure: IP40, Terminals: IP20, Clearance: IP54
Resistance to shock:	30 g / 11 ms
Resistance to vibrations to EN 60068-2-6:	10 ... 55 Hz, amplitude 0.35 mm
Altitude:	max. 2,000 m

2.5 Derating / electrical lifespan of safety contacts

No derating with individual installation of modules.

Derating on request if several modules are installed one after the other without spacing and with maximum output load and ambient temperatures.

Electrical life of the safety contacts

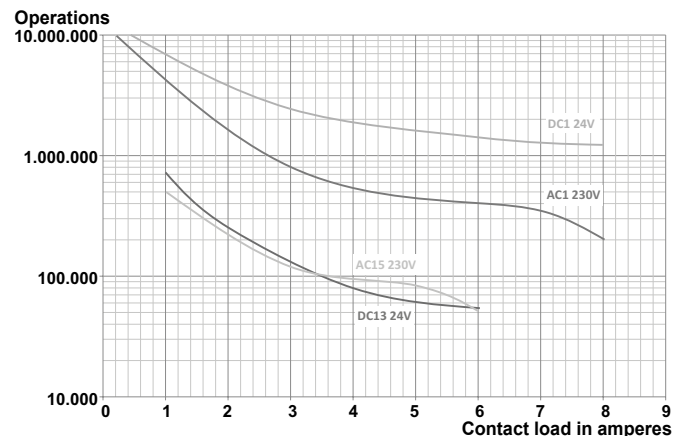

2.6 Safety classification

2.6.1 Safety classification of semi-conductor output

Standards:	ISO 13849-1, IEC 61508, IEC 62061
PL:	up to e
Control category:	up to 4
PFH_D :	$\leq 2.66 \times 10^{-9} / h$
PFD_{avg} :	$\leq 2.42 \times 10^{-5}$
SIL:	suitable for SIL 3 applications
Mission time:	20 years

2.6.2 Classification of relay output

Standards:	ISO 13849-1, IEC 61508, IEC 62061
PL:	up to e
Control category:	up to 4
DC:	high
CCF:	> 65 points
PFH_D :	$\leq 1.25 \times 10^{-8} / h$
PFD_{avg} :	$\leq 5.3 \times 10^{-5}$
SIL:	suitable for SIL 3 applications
Mission time:	20 years

The PFH value of $1.25 \times 10^{-8}/h$ applies to the combinations of contact load (current through enabling contacts) and number of switching cycles (n_{oply}) mentioned in the table below. At 365 operating days per year and a 24-hours operation, this results in the below-mentioned switching cycle times (t_{cycle}) for the relay contacts. Diverging applications upon request.

Contact load	n _{oply}	t _{cycle}
20 %	880,000	0.6 min
40 %	330,000	1.6 min
60 %	110,000	5.0 min
80 %	44,000	12.0 min
100 %	17,600	30.0 min

3. Mounting

3.1 General mounting instructions

Mounting: snaps onto standard DIN rails to EN 60715.

Hook bottom of enclosure in standard rail and push down until it engages in position.

3.2 Dimensions

All measurements in mm.

Device dimensions (H/W/D): 98 x 22.5 x 115 mm

4. Electrical connection

4.1 General information for electrical connection



The electrical connection may only be carried out by authorized personnel in a de-energized condition.



If mains unit is a new installation or a replacement, the connector of the output level must be removed and correct connection of the power supply (A1) must be checked.



To avoid EMC disturbances, the physical ambient and operational conditions at the place where the product is installed, must meet the provisions laid down in the paragraph "Electromagnetic Compatibility (EMC)" of EN 60204-1.

4.2 Coding of connecting terminals

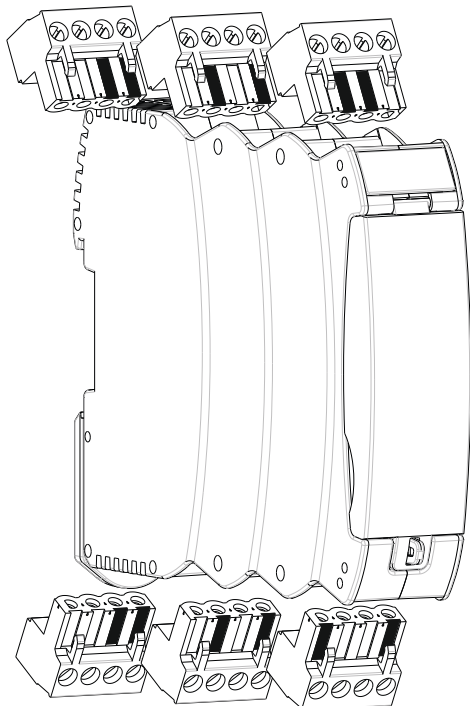

5. Operating principle and settings

5.1 Description of the terminals and LED indications

Clip	Function	LED	Function
A1	Operating voltage + 24 VDC 24 VAC (SRB-E-301ST)	RUN	Operating voltage OK RUN mode For flash code, see section 6.1
A2	Operating voltage 0 V 24 VAC (SRB-E-301ST)		
		ERR	Error code refer to part 6.2
X2	Input of start circuit		
X3	Input feedback circuit		
X7	Input release signal		
S11/S21	Test pulse outputs		
S12	Input channel 1	In 1	High level at S12 For flash code, see section 6.1
S22	Input channel 2	In 2	High level at S22 For flash code, see section 6.1
Y1	Signalling output (NC)		
41/42	Signalling contact (NC)		
Q1/Q2 13/14, 23/24, 33/34	Safety outputs	Out	Outputs activated For flash code, see section 6.1

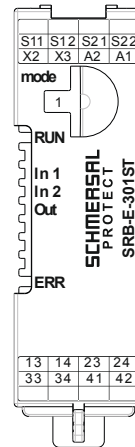
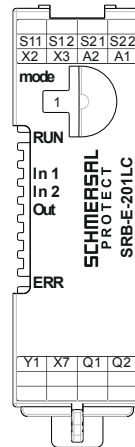
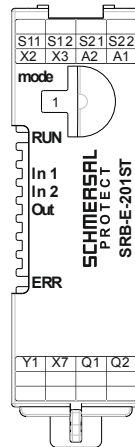

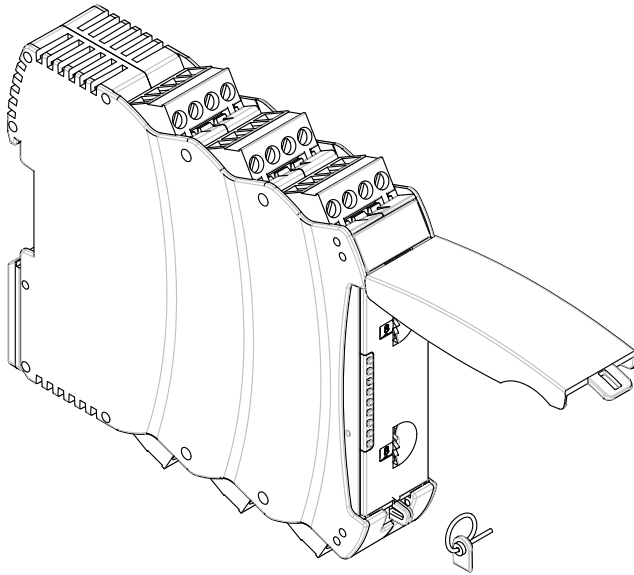

Adjustment of application using rotary “mode” switch

- Open front transparent cover (see fig.).
- Opening is carried out by lifting side with lock.
- Select desired application using rotary mode switch (1 ... 10) by turning up or down (see 5.3).
- After performing setting, close front cover again.
- Front cover can be secured with a lead seal to protect it from being opened unintentionally



Only touch the components after electrical discharge!

5.2 Adjustable applications

Rotary knob position	Reset button (detection of the trailing edge)	Cross-wire monitoring active	Input / Sensor configuration	Monitoring of sensor channels for synchronisation (< 5 sec.)
1	Yes	Yes	NC / NC	Yes
2	Yes	Yes	NC / NC	No
3	Yes	No	NC / NC	Yes
4	Yes	No	NC / NC	No
5	Yes	Yes	NC / NO	Yes
6	Autostart	Yes	NC / NO	No
7	Autostart	Yes	NC / NC	Yes
8	Autostart	Yes	NC / NC	No
9	Autostart	No	NC / NC	Yes
10	Autostart	No	NC / NC	No
11	Function two-hand control type IIIC (SRB-E-201ST)		NC, NO / NC, NO	< 0.5 sec. (upon actuation of setting elements)
SRB-E-301ST: Evaluation of safety mats SMS				
12	Autostart	No	NC / NC	No
13	Yes	No	NC / NC	No
C	Configuration mode			

5.3 Changing setting or application

Description / procedure	Rotary (mode) switch	System response	LED indications			
			RUN	In 1	In 2	Out
Factory setting	Position 1	Ready for application 1	-	-	-	-
Switch operating voltage on	Position 1	Without connected sensors!	Lights up	-	-	-
	Turn to position C	Application 1 is deleted	Lights up	Flashes	Flashes	Flashes
Setting cycle active		Application 1 is deleted	-	-	-	-
		No valid application stored	Flashes	-	-	-
SRB-E ready for new applications						
Select new application	Select desired application (1-11)	New application will be loaded	Lights up	-	-	-
			Lights up	Lights up	-	-
Setting cycle active			Lights up	Lights up	Lights up	-
			Lights up	Lights up	Lights up	Lights up
Ready for operation	The desired application is configured	Adopt new application	Lights up	-	-	-
Switch off operating voltage and connect wires according to selected application -> SRB-E... ready for operation						

6. Diagnostic

6.1 LED indications

LED	Function	Display type
RUN	Ready for operation	Continuously lit
	Not a valid application	Flashes
In 1	Input S12 closed	Continuously lit
	Time window for synchronicity exceeded	Flashes quickly
	Second channel, input S22 has not opened	Flashes slowly
In 2	Input S22 closed	Continuously lit
	Time window for synchronicity exceeded	Flashes quickly
	Second channel, input S12 has not opened	Flashes slowly
Out	Safety outputs ON	Continuously lit
	No release signal on input X7	Flashes quickly
	Safety outputs waiting for start (input X2)	Flashes slowly
	Feedback circuit not closed (input X3)	Flashes slowly

Single flashing of all LEDs with mains on

6.2 Malfunctions

Malfunctions and fault causes are displayed with the ERR-LEDs via short and long flashing signals

LED	Error cause	Long flash	Short flash	
ERR	Operating voltage too low	1	1	
	Operating voltage too high	1	2	
	Invalid rotary switch setting	1	3	
	External voltage on output Q1	1	5, 7, 9	
	External voltage on output Q2	1	6, 8	
		2	1	
	Termination to GND on output Q1	2	2	
	Termination to GND on output Q2	2	3	
	Cross-wire between inputs S12 and S22	2	4	
	Undefined level on outputs:			
	X2	3	4	
	X3	3	5	
	X7	3	9	
	S12	2	9	
	S22	3	1	
Rotary switch > 30 sec. to position C	6	8		
Application changed and activation of operating voltage	LEDs flash quickly: RUN, In 1, In 2, Out			
Application was changed during active operation	LEDs flash quickly: ERR, In 1, In 2, Out			

Other fault codes:

Consult technical sales dept. at Schmersal

7. Wiring examples

7.1 Possible applications

All applications for 1 or 2-channel safe evaluation for protective equipment as follows:

- Safety door monitoring to EN ISO 14119
- Position switches with positive break to EN 60947-5-1
- Safety sensors to EN 60947-5-3
- Emergency stop command devices to EN ISO 13850 and EN 60947-5-5
- Magnetic safety sensors to EN 60947-5-3
- Safety light curtain and photoelectric barriers according to EN 61496
- Two-hand control panels to ISO 13851 type III C
- Safety mats SMS to EN ISO 13856-1

7.2 Application example

Dual-channel control, shown for a guard door monitor with two position switches where one has a positive break contact; with external reset button 

- Relay outputs: Suitable for 2-channel control, for increase in capacity or number of contacts by means of contactors or relays with positive-guided contacts
- H2 = Feedback circuit



The connection of magnetic safety switches to the SRB-E-... safety-monitoring module is only admitted when the requirements of the standard EN 60947-5-3 are observed.

As the technical data are regarded, the following minimum requirements must be met:

- Switching capacity: min. 240 mW
- Switching voltage: min. 24 VDC
- switching current: min. 10 mA



For example, the following safety sensors meet the requirements:

- BNS 36-02Z(G), BNS 36-02/01Z(G)
- BNS 260-02Z(G), BNS 260-02/01Z(G)



When sensors with LED are wired in the control circuit (protective circuit), the following rated operating voltage must be observed and respected: • 24 VDC with a max. tolerance of -5%/+20%

There may be availability problems, particularly in the case of series connection of sensors with a voltage drop in the activation circuit, e.g. one caused by LEDs.



Signalling outputs must not be used in safety circuits.

Wiring examples SRB-E-201ST and SRB-E-201LC

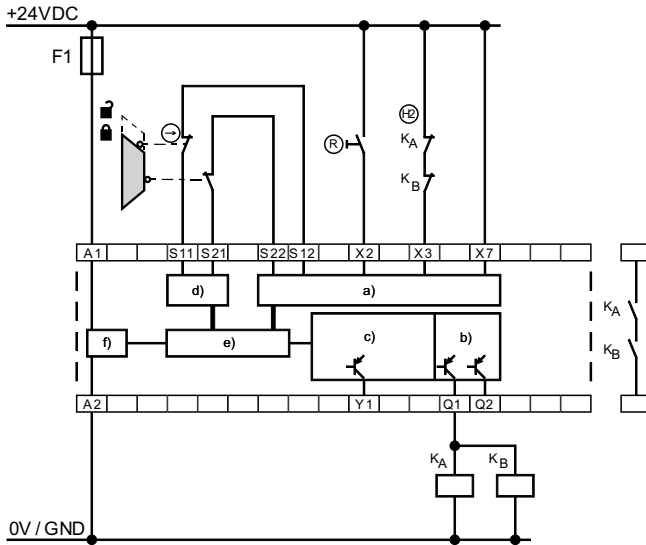

Key

- a) Safety inputs
- b) Safety outputs
- c) Signalling outputs
- d) Clock outputs
- e) Processing
- f) Power

7.3 Start configuration

7.3.1 Monitored start

- Manual start or activation of the module occurs when the button is released.



Monitoring of max. actuation time 0.03 sec. ... 3 sec.
If the time is exceeded, the module cannot be started!

7.3.2 Reset without monitoring / autostart

- The manual start or the activation of the module occurs when the button is pressed (not when it is released!).
- With autostart, X2 must be bridged to S11, S21 or +24 VDC



Not admitted without additional measure due to the risk of gaining access by stepping behind!



Within the meaning of EN 60204-1 paragraph 9.2.5.4.2, the operating mode "automatic start" is only restrictedly admissible. In particular, any inadvertent restart of the machine must be prevented by other suitable measures.

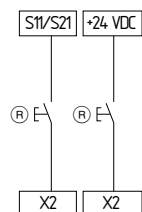

Reset button (detection of the trailing edge)	Reset without monitoring / autostart
Rotary knob position 1	Rotary knob position 6
Rotary knob position 2	Rotary knob position 7
Rotary knob position 3	Rotary knob position 8
Rotary knob position 4	Rotary knob position 9
Rotary knob position 5	Rotary knob position 10

Wiring example SRB-E-301ST

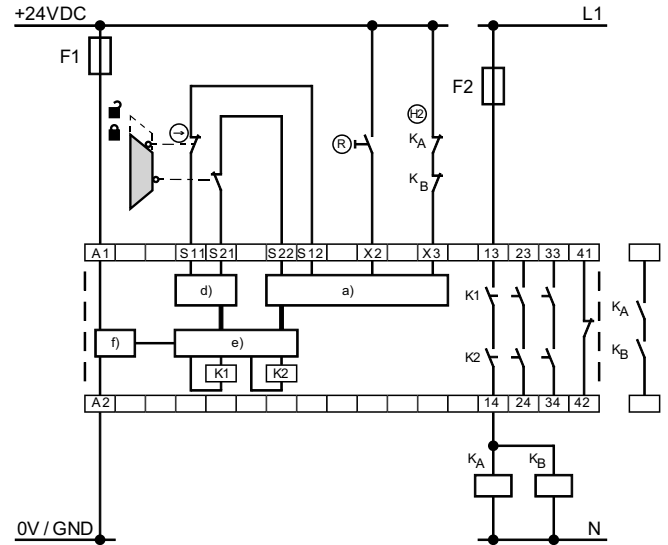

7.4 Feedback circuit

- Suitable for increase in capacity or number of contacts by means of contactors or relays with positive-guided contacts. If the feedback circuit is not required, establish a bridge.

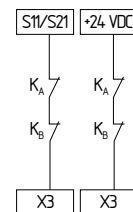

7.5 Release signal SRB-E-201..

- The safety outputs Q1 and Q2 can be switched during operation via the safety input X7 with the guard system closed.
- For safety-orientated use, a fault in the wiring (short circuit to 24 V potential) must be able to be excluded!
- If no deactivation during operation is required, this input must be switched to + 24 VDC.

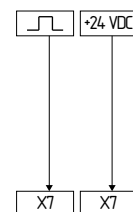

⎓ = control signal

7.6 Sensor configuration

Single channel signal processing

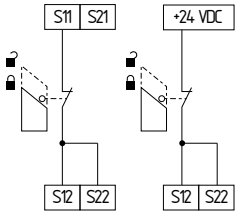

Rotary knob position	Function
4	Reset button (detection of the trailing edge)
10	Reset without monitoring / autostart

Dual channel signal processing NC / NC

With cross-wire monitoring

(Category 4 – PL e to ISO 13849-1 possible)

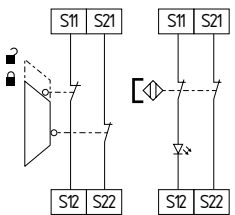

Rotary knob position	Cross-wire monitoring	Synchronisation
1	Yes	Yes
2	Yes	No
7	Yes	Yes
8	Yes	No

Without cross-wire monitoring

(Cat. 4 – PL e to ISO 13849-1 only possible with protective wiring)

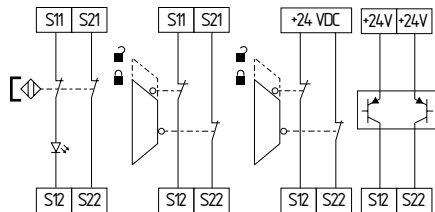

Rotary knob position	Cross-wire monitoring	Synchronisation
3	No	Yes
4	No	No
9	No	Yes
10	No	No

Dual channel signal processing NC / NO

(Category 4 – PL e to ISO 13849-1 possible)

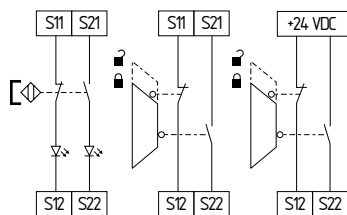

Rotary knob position	Function
5	Reset button (detection of the trailing edge)
6	Reset without monitoring / autostart

Two hand switch (only with SRB-E-201ST)

- Malfunctions of every contact as well as earth leakages and cross-wire shorts are detected.
- The feedback circuit (H2) is integrated as shown. The safety-technical function of external positive-guided contactors is monitored by a series-wiring of the NC contacts with the input X7. In idle state, this circuit must be closed.
- If the feedback circuit is not required, establish a bridge.

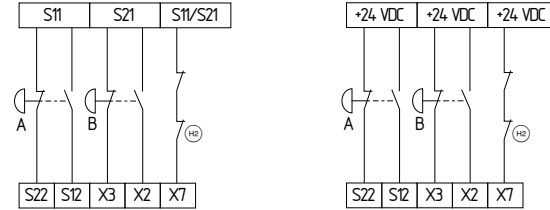

Rotary knob position	Function
11	Function two-hand control type I IIC

Safety mat according to EN ISO 13856-1 (only with SRB-E-301ST)

- In combination with SMS safety mat (from Schmersal)
- Without reset function
- The connection of the inputs is realised through the safety mat here.
- When the safety mat is actuated, the potentials of both inputs are connected, so that a cross-wire short is created and the device is safely shut down.
- Category 3 – PL d to ISO 13849-1 possible.

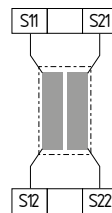

Rotary knob position	Function
12	Safety mat, Autostart
13	Safety mat, reset button

8. Set-up and maintenance

8.1 Commissioning

The safety relay module features protection class IP54 for installation in a switch cabinet.

The safety relay module is delivered ready for operation.

Application 1 is preset in the factory.

8.2 Functional testing

The safety function of the safety-monitoring module must be tested.

The following conditions must be previously checked and met:

1. Correct fixing
2. Check the integrity of the cable entry and connections
3. Check the safety-monitoring module's enclosure for damage
4. Check the electrical function of the connected sensor technology and their influence on the safety-monitoring module and the downstream actuators

The safety relay module features self-test functions.

If a fault is detected, the system adopts a safe mode and leads, if necessary, to undelayed deactivation of all safety outputs.

8.3 Behaviour in the case of faults

In the event of a fault the following procedure is recommended:

1. Identify faults according to flash codes from chapter 6.2.
 2. Rectify the fault if it is described in the table.
 3. Switch operating voltage off and on and erase fault mode.
- If fault could not be rectified, please contact the manufacturer.

8.4 Setting report

This report regarding the setting of the device must be completed accordingly by the customer and enclosed in the technical documentation of the machine.

The setting report must be available whenever a safety check is performed.

Company: _____

The safety-monitoring module is used in the following machine:

Machine n°	Machine type	Module n°

Configured application (mode): _____

Set on (date)	Signature of the responsible person

8.5 Maintenance

A regular visual inspection and functional test, including the following steps, is recommended:

1. Check the correct fixing of the safety-monitoring module
2. Check the cable for damages
3. Check electrical function



If a manual functional check is necessary to detect a possible accumulation of faults, then this must take place during the intervals noted as follows:

- at least every month for PL e with category 3 or category 4 (according to ISO 13849-1) or SIL 3 with HFT (hardware fault tolerance) = 1 (according to IEC 62061);
- at least every 12 months for PL d with category 3 (according to ISO 13849-1) or SIL 2 with HFT (hardware fault tolerance) = 1 (according to IEC 62061).

Damaged or defective components must be replaced.

9. Disassembly and disposal

9.1 Disassembly

The safety-monitoring module must be disassembled in a de-energised condition only.

9.2 Disposal

The safety-monitoring module must be disposed of in an appropriate manner in accordance with the national prescriptions and legislations.

10. Appendix

10.1 Wiring/circuit information

Wiring example SRB-E-201.. for cascading via safety input X7:

Safety outputs of following SRB-E modules can be switched off in each case via input X7.

For safety-orientated application, a fault in the wiring (short circuit to 24 V potential) must be able to be excluded!

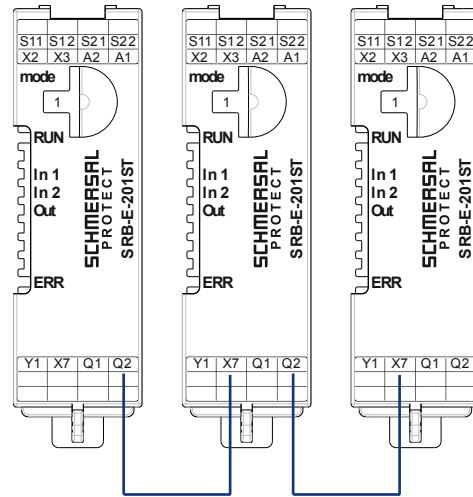

Air clearances and creepage distances of the safety contacts:

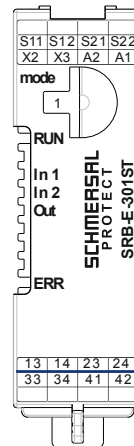

Against all other connection terminals, the safety contacts 13-14 and 23-24 comply without additional measures with the requirements for double insulation in accordance with EN 60664-1 and are to be used with switch voltages > 50 V. The safety contacts 33-34 comply with the requirements for basic insulation.

11. EU Declaration of conformity

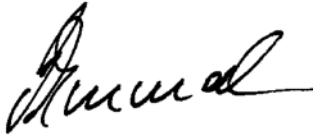
EU Declaration of conformity		
Original	K.A. Schmersal GmbH & Co. KG Möddinghofe 30 42279 Wuppertal Germany Internet: www.schmersal.com	
We hereby certify that the hereafter described components both in their basic design and construction conform to the applicable European Directives.		
Name of the component:	SRB-E-201LC ¹⁾ SRB-E-201ST ²⁾ SRB-E-301ST ¹⁾	
Type:	See ordering code	
Description of the component:	Relay safety combination for emergency-stop circuits, safety guard monitoring, magnetic safety switches, safety mats, two-hand controls and AOPDs.	
Relevant Directives:	Machinery Directive	2006/42/EC
	EMC-Directive	2014/30/EU
	RoHS-Directive	2011/65/EU
Applied standards:	ISO 13851:2002, ISO 13849-1:2015, ISO 13849-2:2012, IEC 61508 parts 1-7:2010, IEC 62061:2015	
¹⁾ Notified body, which approved the full quality assurance system, referred to in Appendix X, 2006/42/EC:	TÜV Rheinland Industrie Service GmbH Am Grauen Stein, 51105 Köln ID n°: 0035	
²⁾ Notified body for the prototype test:	TÜV Rheinland Industrie Service GmbH Am Grauen Stein, 51105 Köln ID n°: 0035	
²⁾ EC-prototype test certificate:	01/205/5635.00/18	
Person authorised for the compilation of the technical documentation:	Oliver Wacker Möddinghofe 30 42279 Wuppertal	
Place and date of issue:	Wuppertal, February 23, 2022	
SRB-E-201ST-F-EN		
	Authorised signature Philip Schmersal Managing Director	



The currently valid declaration of conformity can be downloaded from the internet at products.schmersal.com.

