

# Metal One-touch Fittings

## Compact and Light

New

RoHS

Dimensions **Approx. 30%**  
\* Comparison with KQBL06-01S

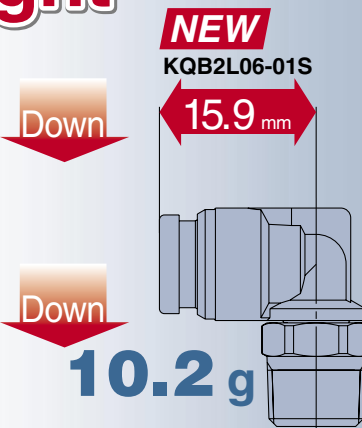

Weight **Approx. 62%**  
\* Comparison with KQBL06-01S

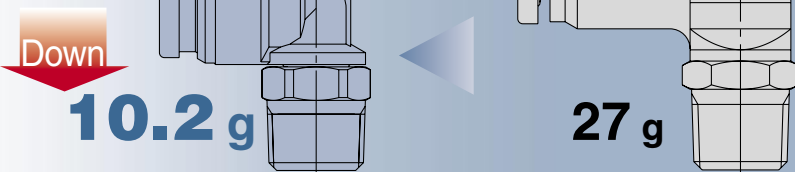

- More configuration variations  
**17** models < **9** models

Fluid temperature **-5 to 150°C**

Connection thread M, R, Rc, UNF, NPT, G

Applicable tube material FEP • PFA • Nylon • Soft nylon  
Polyurethane • Polyolefin

○ Electroless nickel plated  
(Brass parts)

○ Grease-free

### Variations

● Added size

		Applicable tube O.D. (mm)						
		ø3.2	ø4	ø6	ø8	ø10	ø12	ø16
Connection thread	M5	●	●	●	●	●	●	●
	R1/8	●	●	●	●	●	●	●
	G1/8	●	●	●	●	●	●	●
	R1/4	●	●	●	●	●	●	●
	G1/4	●	●	●	●	●	●	●
	R3/8	●	●	●	●	●	●	●
	G3/8	●	●	●	●	●	●	●
	R1/2	●	●	●	●	●	●	●
	G1/2	●	●	●	●	●	●	●
	No thread	●	●	●	●	●	●	●

		Applicable tube O.D. (inch)					
		ø1/8"	ø5/32"	ø1/4"	ø5/16"	ø3/8"	ø1/2"
Connection thread	10-32 UNF	●	●	●	●	●	●
	NPT1/8	●	●	●	●	●	●
	NPT1/4	●	●	●	●	●	●
	NPT3/8	●	●	●	●	●	●
	NPT1/2	●	●	●	●	●	●
	No thread	●	●	●	●	●	●

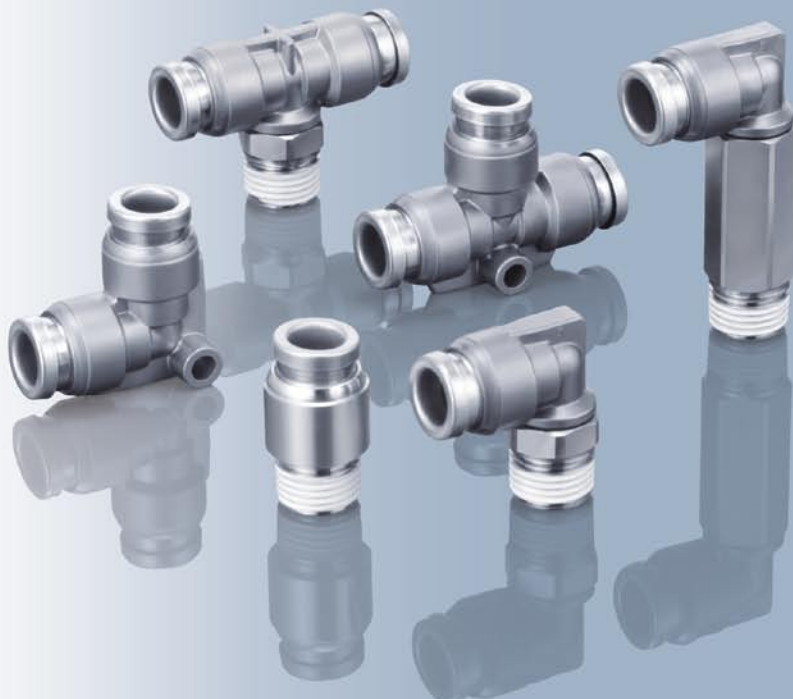

Series **KQB2**



CAT.EUS50-34A-UK

### Compact and light

Dimensions: Approx. **30%** down  
 \* Comparison with KQBL06-01S

Weight: Approx. **62%** down  
 \* Comparison with KQBL06-01S

More tube sizes added  
 Ø3.2 (Ø1.8") and Ø16 have been added.

More configuration variations  
**17** models < **9** models

Inch size x UNF/NPT thread,  
 Metric size x G thread added

Applicable tube size  
 Ø3.2 to Ø16, Ø1/8" to Ø1/2"

Connection thread: M, R, Rc, UNF, NPT, G

Fluid temperature: **-5 to 150°C**

Grease-free

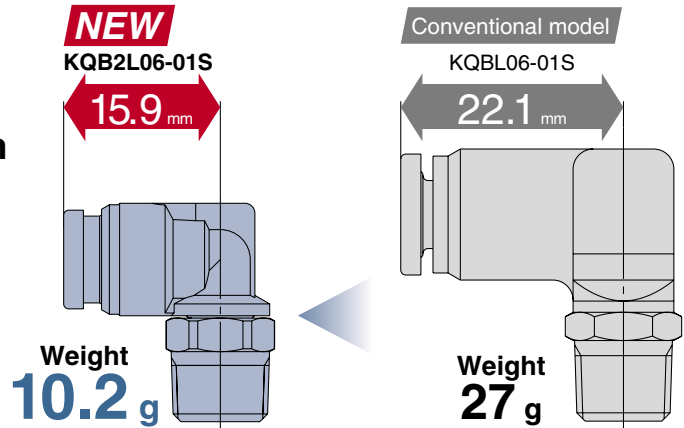

### Applicable tube material

FEP • PFA • Nylon • Soft nylon  
 Polyurethane • Polyolefin

### Electroless nickel plated (Brass parts)

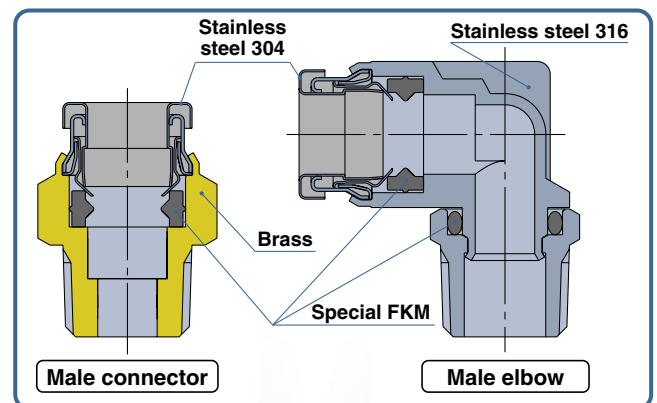

**Stainless steel 304**

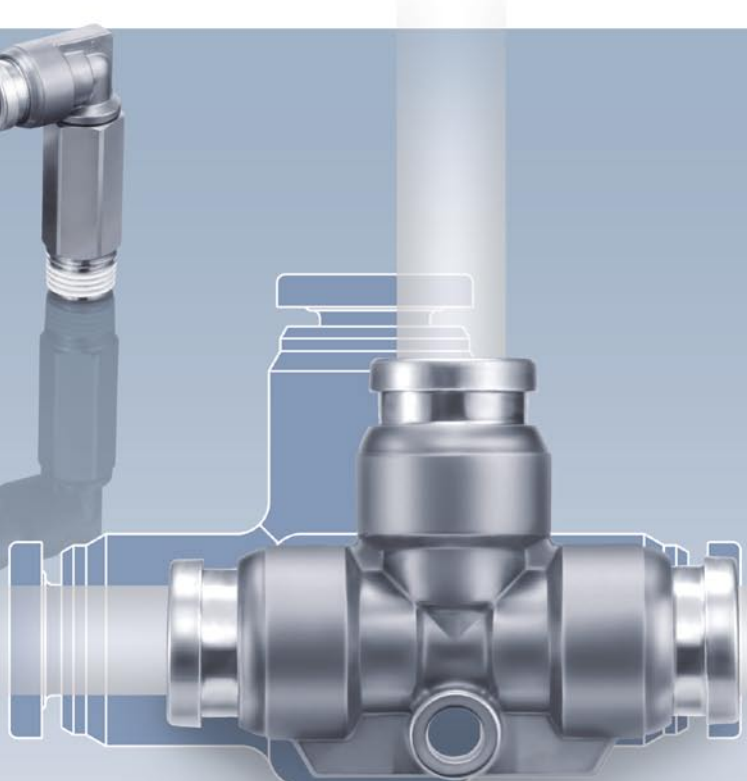

### Variations

#### Male Connector **KQB2H**



Metric  
R thread ..... P. 3  
G thread ..... P. 16  
Inch ..... P. 10

#### Bulkhead Union **KQB2E**



Metric ..... P. 5  
Inch ..... P. 12

#### Different Diameter Union "Y" **KQB2U**



Metric ..... P. 6  
Inch ..... P. 13

#### Hexagon Socket Head Male Connector **KQB2S**



Metric  
R thread ..... P. 3  
G thread ..... P. 16  
Inch ..... P. 10

#### Union Tee **KQB2T**



Metric ..... P. 5  
Inch ..... P. 12

#### Bulkhead Connector **KQB2E**



Metric  
Rc thread ..... P. 7  
G thread ..... P. 18  
Inch ..... P. 13

#### Straight Union **KQB2H**



Metric ..... P. 3  
Inch ..... P. 10

#### Union "Y" **KQB2U**



Metric ..... P. 5  
Inch ..... P. 12

#### Extended Male Elbow **KQB2W**



Metric  
R thread ..... P. 7  
G thread ..... P. 18  
Inch ..... P. 13

#### Male Elbow **KQB2L**



Metric  
R thread ..... P. 4  
G thread ..... P. 17  
Inch ..... P. 11

#### Different Diameter Tee **KQB2T**



Metric ..... P. 6  
Inch ..... P. 12

#### Female Connector **KQB2F**



Metric  
Rc thread ..... P. 8  
G thread ..... P. 18  
Inch ..... P. 14

#### Male Branch Tee **KQB2T**



Metric  
R thread ..... P. 4  
G thread ..... P. 17  
Inch ..... P. 11

#### Plug-in Reducer **KQB2R**



Metric ..... P. 6  
Inch ..... P. 12

#### Plug **KQB2P**



Metric ..... P. 8  
Inch ..... P. 14

#### Union Elbow **KQB2L**



Metric ..... P. 5  
Inch ..... P. 11

#### Different Diameter Straight **KQB2H**



Metric ..... P. 6  
Inch ..... P. 13

# Metal One-touch Fittings

Applicable Tube: Metric Size, Connection Thread: M, R, Rc

## Series **KQB2**

RoHS



### Applicable Tube

Tube material	FEP, PFA, Nylon, Soft nylon <sup>Note 1)</sup> , Polyurethane, Polyolefin
Tube O.D.	ø3.2, ø4, ø6, ø8, ø10, ø12, ø16

### Specifications

Fluid	Air, Water
Operating pressure range <sup>Note 2)</sup>	-100 kPa to 1 MPa <sup>Note 3)</sup>
Proof pressure	3.0 MPa
Ambient and fluid temperature <sup>Note 4)</sup>	-5 to 150°C (No freezing) <sup>Note 3)</sup>
Lubricant	Grease-free specification
Seal on the threads	With sealant

Note 1) For soft nylon tube, water cannot be used.

Note 2) Avoid using in a vacuum holding application such as a leak tester, since there is leakage.

Note 3) Check the operating pressure range and operating temperature range of the tube.

Note 4) It is recommended that you use the inner sleeve in the following conditions (Except ø3.2):

- When using in an environment where the fluid temperature changes drastically.
- When using at a high temperature.

#### \* Temperature Condition of Mounting the Inner Sleeve

Tube	Temperature
FEP tube/TH series	80°C or more
PFA tube/TL series	120°C or more

### Spare Parts

Description	Tube O.D.	Part no.	Material
Gasket	—	<b>M-5G3</b>	Stainless steel 316, Special FKM
Bulkhead nut	ø3.2 ø4	<b>KQB223-P01</b>	C3604 (Electroless nickel plated)
	ø6	<b>KQB206-P01</b>	
	ø8	<b>KQB208-P01</b>	
	ø10	<b>KQB210-P01</b>	
	ø12	<b>KQB212-P01</b>	
	ø16	<b>KQB216-P01</b>	

### Cross Reference Table of the Inner Sleeve

Tube O.D.	Tube material			Applicable inner sleeve	
	TUS (Soft polyurethane)	TH/TIH (FEP)	TL/TIL (PFA)	Part no.	Length
ø4	—	TH0402	—	<b>TJ-0402</b>	18
	TUS0425	TH0425	—	<b>TJ-0425</b>	18
	—	—	TL0403	<b>TJ-0403</b>	18
ø6	TUS0604	TH0604	TL0604	<b>TJ-0604</b>	19
	TUS0805	—	—	<b>TJ-0805</b>	20.5
ø8	—	TH0806	TL0806	<b>TJ-0806</b>	20.5
	TUS1065	—	—	<b>TJ-1065</b>	23
ø10	—	TH1075	—	<b>TJ-1075</b>	23
	—	TH1008	TL1008	<b>TJ-1008</b>	23
	TUS1208	—	—	<b>TJ-1208</b>	24
ø12	—	TH1209	—	<b>TJ-1209</b>	24
	—	TH1210	TL1210	<b>TJ-1210</b>	24
	—	—	—	—	—

\* C2700 + Electroless nickel plated is used for the TJ series.

### Construction

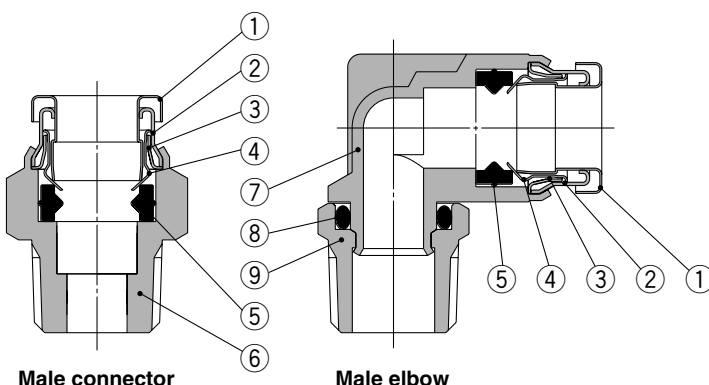

### Component Parts

No.	Description	Material
1	Release button	Stainless steel 304
2	Guide 1	Stainless steel 304
3	Guide 2	Stainless steel 304
4	Chuck	Stainless steel 304
5	Seal	Special FKM (Fluoro coated)
6	Male connector body	C3604 (Electroless nickel plated)
7	Male elbow body	Stainless steel 316
8	O-ring	Special FKM (Fluoro coated)
9	Stud	C3604 (Electroless nickel plated)

## Dimensions

### Male Connector: KQB2H



Applicable tube O.D. (mm)	Connection thread R, M	Model	H (Width across flat)	Note 1) $\phi D$	L	A*	M	Note 2) Effective area (mm <sup>2</sup> )	Weight (g)
$\phi 3.2$	M5	KQB2H23-M5	8	8	16.5	13.5	12	3	3.4
	1/8	KQB2H23-01S	10		15.4	12.3			
	1/4	KQB2H23-02S	14		21	16.3			
$\phi 4$	M5	KQB2H04-M5	10	8.7	17.1	14.1	12.6	4	5.3
	1/8	KQB2H04-01S	10		15.3	12.2			
	1/4	KQB2H04-02S	14		20.9	16.2			
$\phi 6$	M5	KQB2H06-M5	12	11.1	19.1	16.1	13.6	4	8
	1/8	KQB2H06-01S	12		18.1	15			
	1/4	KQB2H06-02S	14		20.8	16.1			
	3/8	KQB2H06-03S	17		23	17.9			
$\phi 8$	1/8	KQB2H08-01S	14	13.4	24.5	21.4	16.1	26.1	13.5
	1/4	KQB2H08-02S	14		22.3	17.6			
	3/8	KQB2H08-03S	17		23.7	18.6			
$\phi 10$	1/8	KQB2H10-01S	17	16.4	25.5	22.4	17	26.1	19.8
	1/4	KQB2H10-02S	17		27.9	23.2			
	3/8	KQB2H10-03S	17		23	17.9			
	1/2	KQB2H10-04S	22		28.6	22.2			
$\phi 12$	1/4	KQB2H12-02S	19	18.5	30.5	25.8	18.6	58.3	28.8
	3/8	KQB2H12-03S	19		24.7	19.6			
	1/2	KQB2H12-04S	22		28.7	22.3			
$\phi 16$	3/8	KQB2H16-03S	24	24.6	33.6	28.5	20.8	81	48.3
	1/2	KQB2H16-04S	24		29.5	23.1			

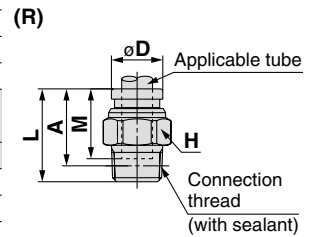
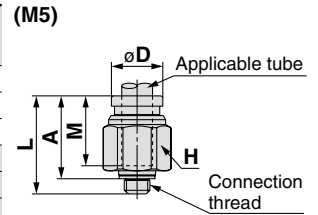

\* Reference dimensions after installation of R thread  
 Note 1)  $\phi D$  is maximum diameter.  
 Note 2) Value of FEP tube.  
 Value of nylon tube for  $\phi 16$  only.

### Hexagon Socket Head Male Connector: KQB2S



Applicable tube O.D. (mm)	Connection thread R, M	Model	H (Width across flat)	Note 1) $\phi D$	L	A*	M	Note 2) Effective area (mm <sup>2</sup> )	Weight (g)
$\phi 3.2$	M5	KQB2S23-M5	2	9	16.5	13.5	12	3	4
$\phi 4$	M5	KQB2S04-M5	2	9	17.1	14.1	12.6	4	3.9
	1/8	KQB2S04-01S	3	10	20.4	17.3			
$\phi 6$	M5	KQB2S06-M5	2	12	19.6	16.6	13.6	4	7.8
	1/8	KQB2S06-01S	4		20.6	17.5			
	1/4	KQB2S06-02S	4		15.9	10.7			
$\phi 8$	1/8	KQB2S08-01S	5	14	24.7	21.6	16.1	23.3	13
	1/4	KQB2S08-02S	6		22.9	18.2			
	3/8	KQB2S08-03S	6		23.1	18			
$\phi 10$	1/8	KQB2S10-01S	5	17	25.6	22.5	17	39	18.6
	1/4	KQB2S10-02S	8		27.5	22.8			
	3/8	KQB2S10-03S	8		24	18.9			
	1/2	KQB2S10-04S	22		17.6	39.2			
$\phi 12$	1/4	KQB2S12-02S	8	19	30.6	25.9	18.6	60	26
	3/8	KQB2S12-03S	10		24.9	19.8			
	1/2	KQB2S12-04S	10		18.5	35.3			
$\phi 16$	3/8	KQB2S16-03S	10	24.6	33.2	28.1	20.8	81	43.6
	1/2	KQB2S16-04S	12		29.4	23			

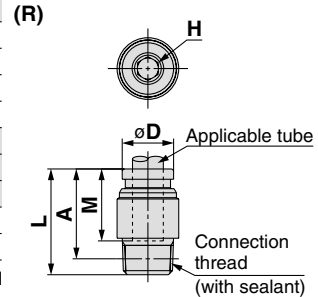
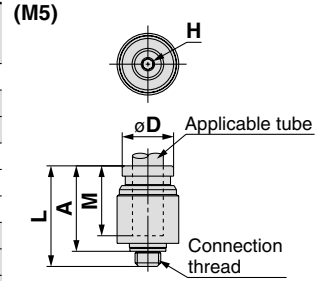

\* Reference dimensions after installation of R thread  
 Note 1)  $\phi D$  is maximum diameter.  
 Note 2) Value of FEP tube.  
 Value of nylon tube for  $\phi 16$  only.

### Straight Union: KQB2H



Applicable tube O.D. (mm)	Model	$\phi D$ Note 1)	L	M	Note 2) Effective area (mm <sup>2</sup> )	Weight (g)
$\phi 3.2$	KQB2H23-00	9	25	12	3.4	6.8
$\phi 4$	KQB2H04-00	9	26.2	12.6	5.6	6.8
$\phi 6$	KQB2H06-00	12	28.2	13.6	13.1	12
$\phi 8$	KQB2H08-00	14	33.2	16.1	26.1	17.4
$\phi 10$	KQB2H10-00	17	35	17	41.5	27.2
$\phi 12$	KQB2H12-00	19	38.2	18.6	58.3	33.7
$\phi 16$	KQB2H16-00	24.6	42.6	20.8	113	56.1

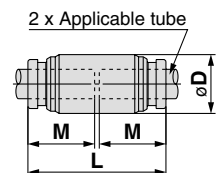

Note 1)  $\phi D$  is maximum diameter.  
 Note 2) Value of FEP tube.  
 Value of nylon tube for  $\phi 16$  only.

# Series KQB2

Applicable Tube: Metric Size, Connection Thread: M, R, Rc

## Dimensions

### Male Elbow: KQB2L



Applicable tube O.D. (mm)	Connection thread R, M	Model	H (Width across flat)	Note 1) $\phi D$	L1	L2	A*	M	Note 2) Effective area (mm <sup>2</sup> )	Weight (g)
$\phi 3.2$	M5	KQB2L23-M5	8	8.3	13.1	14.8	16	12	2.6	6.5
	1/8	KQB2L23-01S	10		13.6	14.9	15.9		3	8
	1/4	KQB2L23-02S	14		18.7	18.1	16.6			
$\phi 4$	M5	KQB2L04-M5	8	9.1	13.7	15.2	16.8	12.6	3.5	7
	1/8	KQB2L04-01S	10		14.4	15.3	16.7		4.2	8.6
	1/4	KQB2L04-02S	14		19.1	18.9	17.5			
$\phi 6$	M5	KQB2L06-M5	8	11.4	14.7	16.3	19	13.6	3.5	9
	1/8	KQB2L06-01S	10		16.4	16.4	19		11.4	10.2
	1/4	KQB2L06-02S	14		15.9	20.2	21.2		19.1	
	3/8	KQB2L06-03S	17		21.6	22.2	31.2			
$\phi 8$	1/8	KQB2L08-01S	12	13.7	18.6	18.3	22	16.1	21.6	14.8
	1/4	KQB2L08-02S	14		19.1	21.5	23.6		20.8	
	3/8	KQB2L08-03S	17		22.9	24.6	32.8			
$\phi 10$	1/8	KQB2L10-01S	12	16.6	20	19.7	24.9	17	21.6	20.4
	1/4	KQB2L10-02S	14		22.9	26.5	23.7			
	3/8	KQB2L10-03S	17		21	24.3	27.5		35.2	34.5
	1/2	KQB2L10-04S	22		28.5	30.4	62.6			
$\phi 12$	1/4	KQB2L12-02S	14	18.7	22.6	24	28.6	18.6	50.2	27.4
	3/8	KQB2L12-03S	17		23.6	25.3	29.5		34.3	
	1/2	KQB2L12-04S	22		29.5	32.4	60.8			
$\phi 16$	3/8	KQB2L16-03S	19	24.6	26.3	28	34.5	20.8	71	47
	1/2	KQB2L16-04S	22		27.3	31.8	37		100	62.6

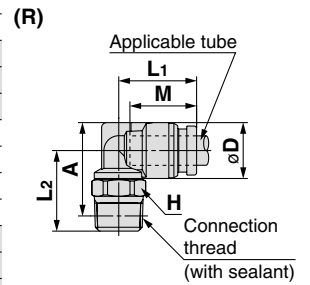
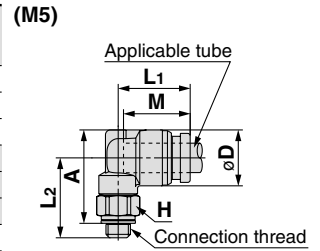

\* Reference dimensions after installation of R thread  
 Note 1)  $\phi D$  is maximum diameter.  
 Note 2) Value of FEP tube.  
 Value of nylon tube for  $\phi 16$  only.

### Male Branch Tee: KQB2T



Applicable tube O.D. (mm)	Connection thread R, M	Model	H (Width across flat)	Note 1) $\phi D$	L1	L2	A*	M	Note 2) Effective area (mm <sup>2</sup> )	Weight (g)
$\phi 3.2$	M5	KQB2T23-M5	8	8.3	13.1	14.8	16	12	3.2	8.2
	1/8	KQB2T23-01S	10		13.6	14.9	15.9		3.4	9.6
	1/4	KQB2T23-02S	14		18.7	18.1	18.4			
$\phi 4$	M5	KQB2T04-M5	8	9.1	13.7	15.2	16.8	12.6	4.5	9.1
	1/8	KQB2T04-01S	10		14.4	15.3	16.7		6	10.6
	1/4	KQB2T04-02S	14		19.1	18.9	19.4			
$\phi 6$	M5	KQB2T06-M5	8	11.4	14.7	16.3	19	13.6	4.5	12.1
	1/8	KQB2T06-01S	10		16.4	16.4	19		13.9	13.6
	1/4	KQB2T06-02S	14		15.9	20.2	21.2		22.5	
	3/8	KQB2T06-03S	17		21.6	22.2	35			
$\phi 8$	1/8	KQB2T08-01S	12	13.7	18.6	18.3	22	16.1	26.3	20
	1/4	KQB2T08-02S	14		19.1	21.5	23.6		26.1	
	3/8	KQB2T08-03S	17		22.9	24.6	38			
$\phi 10$	1/8	KQB2T10-01S	12	16.6	20	19.7	24.9	17	40.8	28.6
	1/4	KQB2T10-02S	14		22.9	26.5	31.5			
	3/8	KQB2T10-03S	17		21	24.3	27.5		42.4	
	1/2	KQB2T10-04S	22		28.5	30.4	70.4			
$\phi 12$	1/4	KQB2T12-02S	14	18.7	22.6	24	28.6	18.6	57.2	38.1
	3/8	KQB2T12-03S	17		23.6	25.3	29.5		39.7	
	1/2	KQB2T12-04S	22		29.5	32.4	70.8			
$\phi 16$	3/8	KQB2T16-03S	19	24.6	26.3	28	34.5	20.8	71	64.4
	1/2	KQB2T16-04S	22		27.3	31.8	37		100	79

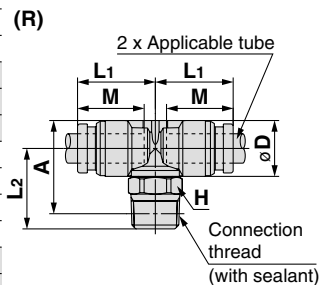
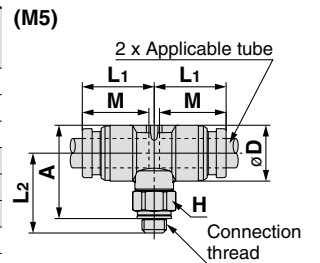

\* Reference dimensions after installation of R thread  
 Note 1)  $\phi D$  is maximum diameter.  
 Note 2) Value of FEP tube.  
 Value of nylon tube for  $\phi 16$  only.

## Dimensions

### Union Elbow: KQB2L



Applicable tube O.D. (mm)	Model	Note 1) $\phi D$	L	A	Q	M	$\phi N$	$\phi O$	Note 2) Effective area (mm <sup>2</sup> )	Weight (g)
$\phi 3.2$	KQB2L23-00	8.3	13.6	19.3	2.9	12	3.2	5.6	3	6.3
$\phi 4$	KQB2L04-00	9.1	14.6	20.5	3.1	12.6	3.2	5.6	4.2	7.4
$\phi 6$	KQB2L06-00	11.4	16.6	23	3.6	13.6	3.2	5.6	11.4	11
$\phi 8$	KQB2L08-00	13.7	20.1	29.1	5	16.1	4.2	8	21.6	20.2
$\phi 10$	KQB2L10-00	16.6	22	31.7	5.7	17	4.2	8	35.2	29.6
$\phi 12$	KQB2L12-00	18.7	24.6	35	6.4	18.6	4.2	8	50.2	37.1
$\phi 16$	KQB2L16-00	24.6	28.8	40.5	7.7	20.8	4.2	8	100	59.7

Note 1)  $\phi D$  is maximum diameter.

Note 2) Value of FEP tube.

Value of nylon tube for  $\phi 16$  only.

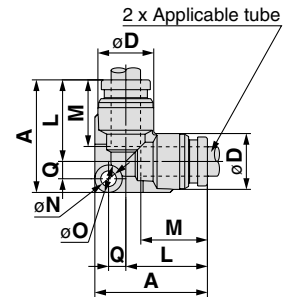

### Bulkhead Union: KQB2E



Applicable tube O.D. (mm)	Model	T (M)	H (Width across flat)	L	Mounting hole	M	Note 2) Effective area (mm <sup>2</sup> )	Weight (g)
$\phi 3.2$	KQB2E23-00	M10 x 1	12	32.2	11	12	3.4	14.8
$\phi 4$	KQB2E04-00	M10 x 1	12	32.4	11	12.6	5.6	14.7
$\phi 6$	KQB2E06-00	M14 x 1	17	35.4	15	13.6	13.1	29.2
$\phi 8$	KQB2E08-00	M15 x 1	19	38.8	16	16.1	26.1	34.9
$\phi 10$	KQB2E10-00	M18 x 1	21	40	19	17	41.5	47.1
$\phi 12$	KQB2E12-00	M20 x 1	24	42.4	21	18.6	58.3	58.7
$\phi 16$	KQB2E16-00	M27 x 1	30	46.8	28	20.8	113	107.2

Note) Value of FEP tube.

Value of nylon tube for  $\phi 16$  only.

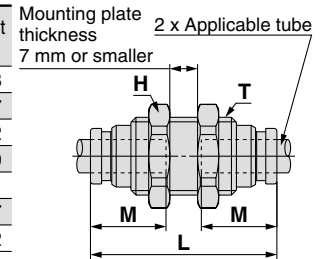

### Union Tee: KQB2T



Applicable tube O.D. (mm)	Model	Note 1) $\phi D$	L	A	Q	M	$\phi N$	$\phi O$	Note 2) Effective area (mm <sup>2</sup> )	Weight (g)
$\phi 3.2$	KQB2T23-00	8.3	13.6	20.5	4.1	12	3.2	5.6	3.4	7.9
$\phi 4$	KQB2T04-00	9.1	14.6	21.8	4.4	12.6	3.2	5.6	6.4	9.5
$\phi 6$	KQB2T06-00	11.4	16.6	24.6	5.2	13.6	3.2	5.6	13.4	14.2
$\phi 8$	KQB2T08-00	13.7	20.1	31.1	7	16.1	4.2	8	25.6	24.4
$\phi 10$	KQB2T10-00	16.6	22	34	8	17	4.2	8	40	36.8
$\phi 12$	KQB2T12-00	18.7	24.6	37.7	9.1	18.6	4.2	8	57.4	47
$\phi 16$	KQB2T16-00	24.6	28.8	43.4	10.6	20.8	4.2	8	100	75.5

Note 1)  $\phi D$  is maximum diameter.

Note 2) Value of FEP tube.

Value of nylon tube for  $\phi 16$  only.

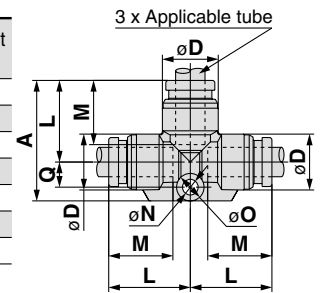

### Union "Y": KQB2U



Applicable tube O.D. (mm)	Model	Note 1) $\phi D$	W	L1	L2	P	M	$\phi N$	$\phi O$	Note 2) Effective area (mm <sup>2</sup> )	Weight (g)
$\phi 3.2$	KQB2U23-00	8.3	16.4	29	11	8.1	12	3.2	5.6	3.4	9.2
$\phi 4$	KQB2U04-00	9.1	18.2	30.4	11.3	9.1	12.6	3.2	5.6	4.2	11.1
$\phi 6$	KQB2U06-00	11.4	22.9	34.9	12.2	11.5	13.6	3.2	5.6	13.4	18.8
$\phi 8$	KQB2U08-00	13.7	28.3	40.1	14.1	14.6	16.1	4.2	8	25.6	29.7
$\phi 10$	KQB2U10-00	16.6	34.2	44	14.4	17.6	17	4.2	8	40	47.4
$\phi 12$	KQB2U12-00	18.7	38.5	48.4	15.8	19.8	18.6	4.2	8	57.4	62.1
$\phi 16$	KQB2U16-00	24.6	49.3	56.6	17.3	26	20.8	4.2	8	113	110.2

Note 1)  $\phi D$  is maximum diameter.

Note 2) Value of FEP tube.

Value of nylon tube for  $\phi 16$  only.

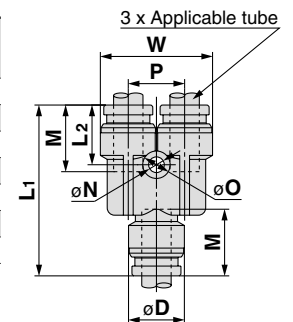

# Series KQB2

Applicable Tube: Metric Size, Connection Thread: M, R, Rc

## Dimensions

### Different Diameter Tee: KQB2T



Applicable tube O.D. (mm)		Model	Note 1) $\phi D_1$	Note 1) $\phi D_2$	$L_1$	$L_2$	$L_3$	Q	$M_1$	$M_2$	$\phi N$	$\phi O$	Note 2) Effective area (mm <sup>2</sup> )	Weight (g)
a	b													
$\phi 3.2$	$\phi 4$	KQB2T23-04	9.1	8.3	14.2	14.1	21.1	4.1	12.6	12	3.2	5.6	3.8	8.5
$\phi 4$	$\phi 6$	KQB2T04-06	11.4	9.1	15.6	15.7	22.8	4.4	13.6	12.6	3.2	5.6	7.1	11
$\phi 6$	$\phi 8$	KQB2T06-08	13.7	11.4	19.1	17.7	29.5	6.4	16.1	13.6	4.2	8	16.4	20
$\phi 8$	$\phi 10$	KQB2T08-10	16.6	13.7	21	21.2	32.1	7.1	17	16.1	4.2	8	36	29.8
$\phi 10$	$\phi 12$	KQB2T10-12	18.7	16.6	23.6	23.1	35.7	8.1	18.6	17	4.2	8	56	41.3
$\phi 12$	$\phi 16$	KQB2T12-16	24.6	18.7	26.8	26.7	39.9	9.1	20.8	18.6	4.2	8	108.5	58

Note 1)  $\phi D_1$ ,  $\phi D_2$  are maximum diameters.  
Note 2) Value of FEP tube.

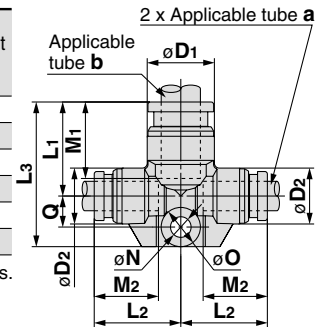

### Plug-in Reducer: KQB2R



Applicable tube O.D. (mm)	Applicable fitting size $\phi d$	Model	Note 1) $\phi D$	L	A	M	Note 2) Effective area (mm <sup>2</sup> )	Weight (g)
$\phi 3.2$	$\phi 4$	KQB2R23-04	9	32.9	20.3	12	3.4	4.9
$\phi 4$	$\phi 6$	KQB2R04-06	9	34.4	20.8	12.6	5.6	7
$\phi 6$	$\phi 8$	KQB2R06-08	12	38.4	22.3	13.6	13.1	12.7
$\phi 8$	$\phi 10$	KQB2R08-10	14	41.9	24.9	16.1	26.1	19.2
$\phi 10$	$\phi 12$	KQB2R10-12	17	44.8	26.2	17	41.5	27.8
$\phi 12$	$\phi 16$	KQB2R12-16	19	42.9	22.1	18.6	58.3	37.2

Note 1)  $\phi D$  is maximum diameter.  
Note 2) Value of FEP tube.

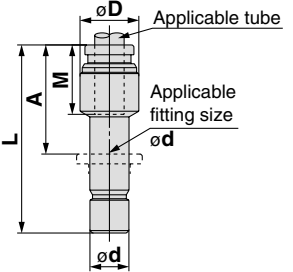

### Different Diameter Straight: KQB2H



Applicable tube O.D. (mm)		Model	$\phi D$ Note 1)	L	$M_1$	$M_2$	Note 2) Effective area (mm <sup>2</sup> )	Weight (g)
a	b							
$\phi 3.2$	$\phi 4$	KQB2H23-04	9	25.6	12	12.6	3.4	6.8
$\phi 4$	$\phi 6$	KQB2H04-06	12	27.2	12.6	13.6	5.6	12.1
$\phi 6$	$\phi 8$	KQB2H06-08	14	30.7	13.6	16.1	13.1	17.1
$\phi 8$	$\phi 10$	KQB2H08-10	17	34.1	16.1	17	26.1	27.2
$\phi 10$	$\phi 12$	KQB2H10-12	19	36.6	17	18.6	41.5	34.8
$\phi 12$	$\phi 16$	KQB2H12-16	24.6	40.4	18.6	20.8	58.3	57.3

Note 1)  $\phi D$  is maximum diameter.  
Note 2) Value of FEP tube.

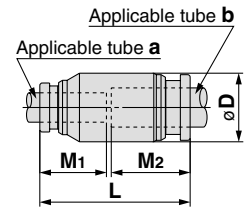

### Different Diameter Union "Y": KQB2U



Applicable tube O.D. (mm)		Model	Note 1) $\phi D$	$L_1$	$L_2$	P	W	$M_1$	$M_2$	$\phi N$	$\phi O$	Note 2) Effective area (mm <sup>2</sup> )	Weight (g)
a	b												
$\phi 3.2$	$\phi 4$	KQB2U23-04	9.1	27	10.8	8.1	16.4	12	12.6	3.2	5.6	3.2	8.5
$\phi 4$	$\phi 6$	KQB2U04-06	11.4	29.3	11.2	9.1	18.2	12.6	13.6	3.2	5.6	4.2	11.9
$\phi 6$	$\phi 8$	KQB2U06-08	13.7	33.7	12.2	11.5	22.9	13.6	16.1	4.2	8	13.4	19.3
$\phi 8$	$\phi 10$	KQB2U08-10	16.6	38.3	13.8	14.6	28.3	16.1	17	4.2	8	25.6	32
$\phi 10$	$\phi 12$	KQB2U10-12	18.7	43	14	17.6	34.2	17	18.6	4.2	8	40	47.6
$\phi 12$	$\phi 16$	KQB2U12-16	24.6	47.4	15.6	19.8	38.5	18.6	20.8	4.2	8	57.4	67.6

Note 1)  $\phi D$  is maximum diameter.  
Note 2) Value of FEP tube.

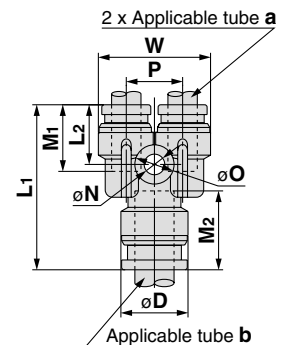



# Metal One-touch Fittings **Series KQB2**

Applicable Tube: Metric Size, Connection Thread: M, R, Rc

## Dimensions

### Bulkhead Connector: KQB2E



Applicable tube O.D. (mm)	Connection thread Rc	Model	T (M)	Width across flat		L1	L2	Mounting hole	M	Note) Effective area (mm <sup>2</sup> )	Weight (g)
				H1	H2						
ø3.2	1/4	KQB2E23-02	M10 x 1	17	12	31	14.8	11	12	3.4	27.5
ø4	1/8	KQB2E04-01	M10 x 1	14	12	25.8	9.7	11	12.6	5.6	16.9
	1/4	KQB2E04-02		17	12	30.9	14.8				27.1
ø6	1/8	KQB2E06-01	M14 x 1	17	17	24.2	6.1	15	13.6	13.1	25
	1/4	KQB2E06-02		19	17	33	14.9				33.2
ø8	3/8	KQB2E06-03	M15 x 1	19	19	34	14.6	16	16.1	26.1	34.8
	1/8	KQB2E08-01		17	19	26.3	6.9				28.7
	1/4	KQB2E08-02		19	19	32.4	13				34.2
ø10	3/8	KQB2E08-03	M18 x 1	19	21	34	12.8	19	17	41.5	35.9
	1/4	KQB2E10-02		19	21	31.6	11.6				44
	3/8	KQB2E10-03		21	24	33.6	13.6				40.2
ø12	3/8	KQB2E12-03	M20 x 1	21	24	34	12.8	21	18.6	58.3	52
	1/2	KQB2E12-04		24	24	39.6	18.4				62.5
ø16	3/8	KQB2E16-03	M27 x 1	29	30	35.3	11.2	28	20.8	96	111
	1/2	KQB2E16-04		40.6	16.5	113	118.2				

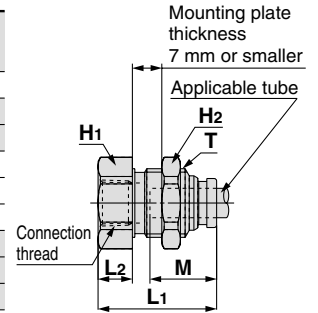

Note) Value of FEP tube.  
Value of nylon tube for ø16 only.

### Extended Male Elbow: KQB2W



Applicable tube O.D. (mm)	Connection thread R, M	Model	H (Width across flat)	Note 1) øD	L1	L2	A*	M	Note 2) Effective area (mm <sup>2</sup> )	Weight (g)
ø3.2	1/8	KQB2W23-01S	10	13.6	31.3	32.3	15.3			
	1/4	KQB2W23-02S	14	35.1	34.5	34.7				
ø4	M5	KQB2W04-M5	8	9.1	13.7	31.6	33.2	12.6	3	14.1
	1/8	KQB2W04-01S	10		14.4	31.7	33.1			16.2
	1/4	KQB2W04-02S	14		35.5	35.3	35.6			
ø6	M5	KQB2W06-M5	8	11.4	14.7	32.7	35.4	13.6	3	16
	1/8	KQB2W06-01S	10		15.9	32.8	37.6			17.8
	1/4	KQB2W06-02S	14		36.6	37.6	37.2			
	3/8	KQB2W06-03S	17		38	38.6	60.3			
ø8	1/8	KQB2W08-01S	12	13.7	18.6	37	40.7	16.1	20.5	28.9
	1/4	KQB2W08-02S	14		19.1	40.2	42.3			39.2
	3/8	KQB2W08-03S	17		41.6	43.3	63.7			
ø10	1/4	KQB2W10-02S	14	16.6	21	46.6	50.2	17	33.5	42.1
	3/8	KQB2W10-03S	17		23.6	45.9	49.1			64.5
	1/2	KQB2W10-04S	22		50.1	52	123			
ø12	1/4	KQB2W12-02S	14	18.7	22.6	47.7	52.3	18.6	47.7	46
	3/8	KQB2W12-03S	17		23.6	49	53.2			58.2
	1/2	KQB2W12-04S	22		53.2	56.1	118			
ø16	3/8	KQB2W16-03S	19	24.6	26.3	57.6	64.1	20.8	71	89.6
	1/2	KQB2W16-04S	22		27.3	61.4	66.6			100

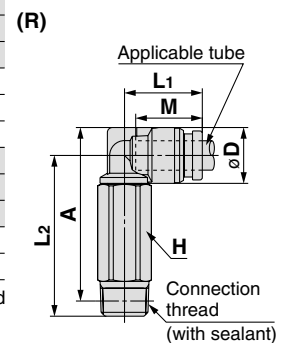
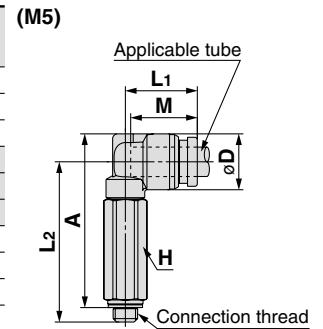

\* Reference dimensions after installation of R thread  
Note 1) øD is maximum diameter.  
Note 2) Value of FEP tube.  
Value of nylon tube for ø16 only.

# Series KQB2

Applicable Tube: Metric Size, Connection Thread: M, R, Rc

## Dimensions

### Female Connector: KQB2F



Applicable tube O.D. (mm)	Connection thread Rc	Model	H (Width across flat)	Note 1) $\phi D$	L1	L2	M	Note 2) Effective area (mm <sup>2</sup> )	Weight (g)
$\phi 3.2$	1/8	KQB2F23-01	12	8	23.3	9.8	12	3.4	9.3
$\phi 4$	1/8	KQB2F04-01	12	8.7	23.7	9.8	12.6	5.6	9.7
	1/4	KQB2F04-02	17		28.7	13.2			22.7
$\phi 6$	1/8	KQB2F06-01	12	11.1	24.2	10	13.6	13.1	11.1
	1/4	KQB2F06-02	17		29.2	13.4			24.3
	3/8	KQB2F06-03	19		30.6	14.2			25.8
$\phi 8$	1/8	KQB2F08-01	14	13.4	26.3	9.6	16.1	26.1	17.1
	1/4	KQB2F08-02	17		31.3	13.7			26.8
	3/8	KQB2F08-03	19		32.7	14.4			28.4
$\phi 10$	1/4	KQB2F10-02	17	16.4	31.6	13.9	17	41.5	30.3
	3/8	KQB2F10-03	19		33	14.7			32
$\phi 12$	1/4	KQB2F12-02	19	18.5	32.6	13.3	18.6	58.3	39.4
	3/8	KQB2F12-03			34	14.7			33.9
	1/2	KQB2F12-04	24		39.3	18.4			52.9
$\phi 16$	3/8	KQB2F16-03	24	24.6	35.3	13.5	20.8	81	62.8
	1/2	KQB2F16-04			40.6	18.8		113	59.9

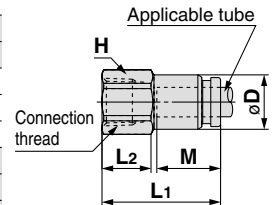

Note 1)  $\phi D$  is maximum diameter.

Note 2) Value of FEP tube.

Value of nylon tube for  $\phi 16$  only.

### Plug: KQB2P



Applicable fitting size $\phi d$	Model	$\phi D$	L	A	Weight (g)
$\phi 3.2$	KQB2P-23	5	28.9	16.9	2.8
$\phi 4$	KQB2P-04	6	29.6	17	4.3
$\phi 6$	KQB2P-06	8	30.8	17.2	9
$\phi 8$	KQB2P-08	10	33.7	17.6	16.3
$\phi 10$	KQB2P-10	12	34.6	17.6	25.4
$\phi 12$	KQB2P-12	14	36.5	17.9	37.8
$\phi 16$	KQB2P-16	18	38.6	17.8	69.2

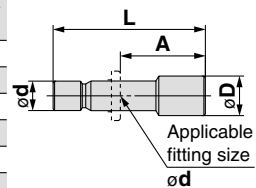

# Metal One-touch Fittings

Applicable Tube: Inch Size, Connection Thread: UNF, NPT

## Series **KQB2**

RoHS



### Applicable Tube

Tube material	FEP, PFA, Nylon, Soft nylon <sup>Note 1)</sup> , Polyurethane, Polyolefin
Tube O.D.	ø1/8", ø5/32", ø1/4", ø5/16", ø3/8", ø1/2"

### Specifications

Fluid	Air, Water
Operating pressure range <sup>Note 2)</sup>	-100 kPa to 1 MPa <sup>Note 3)</sup>
Proof pressure	3.0 MPa
Ambient and fluid temperature <sup>Note 4)</sup>	-5 to 150°C (No freezing) <sup>Note 3)</sup>
Lubricant	Grease-free specification
Seal on the threads	With sealant

Note 1) For soft nylon tube, water cannot be used.

Note 2) Avoid using in a vacuum holding application such as a leak tester, since there is leakage.

Note 3) Check the operating pressure range and operating temperature range of the tube.

Note 4) It is recommended that you use the inner sleeve in the following conditions (Except ø1/8"):

- When using in an environment where the fluid temperature changes drastically.
- When using at a high temperature.

#### \* Temperature Condition of Mounting the Inner Sleeve

Tube	Temperature
FEP tube/TH series	80°C or more
PFA tube/TL series	120°C or more

### Spare Parts

Description	Tube O.D.	Part no.	Material
Gasket	—	<b>M-5G3</b>	Stainless steel 316, Special FKM
Bulkhead nut	ø1/8" ø5/32"	<b>KQB201-P01</b>	C3604 (Electroless nickel plated)
	ø1/4"	<b>KQB207-P01</b>	
	ø5/16"	<b>KQB209-P01</b>	
	ø3/8"	<b>KQB211-P01</b>	
	ø1/2"	<b>KQB213-P01</b>	

### Cross Reference Table of the Inner Sleeve

Tube O.D.	Tube material		Applicable inner sleeve	
	TH/THI (FEP)	TL/TIL (PFA)	Part no.	Length
ø5/32"	TH0402	—	<b>TJ-0402</b>	18
	TH0425	—	<b>TJ-0425</b>	18
ø1/4"	—	TL0403	<b>TJ-0403</b>	18
	TIHB07	TIL07	<b>TJ-0604</b>	19
ø5/16"	TIHA07	—	<b>TJ-0746</b>	19
	TH0806	TL0806	<b>TJ-0806</b>	20.5
ø3/8"	TIHB11	TIL11	<b>TJ-1065</b>	23
	TIHA11	—	<b>TJ-1107</b>	23
ø1/2"	TIH13	TIL13	<b>TJ-1395</b>	24

\* C2700 + Electroless nickel plated is used for the TJ series.

### Construction

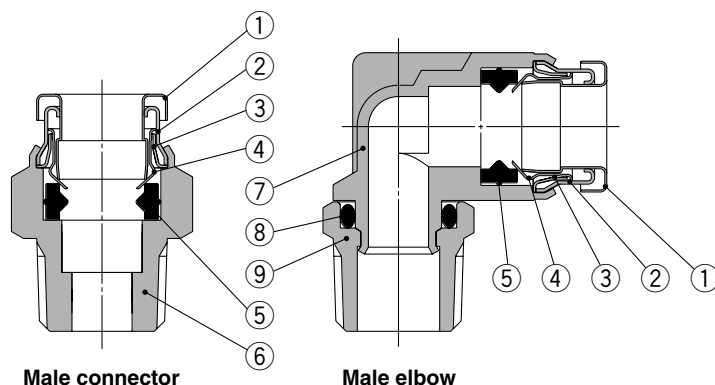

### Component Parts

No.	Description	Material
1	Release button	Stainless steel 304
2	Guide 1	Stainless steel 304
3	Guide 2	Stainless steel 304
4	Chuck	Stainless steel 304
5	Seal	Special FKM (Fluoro coated)
6	Male connector body	C3604 (Electroless nickel plated)
7	Male elbow body	Stainless steel 316
8	O-ring	Special FKM (Fluoro coated)
9	Stud	C3604 (Electroless nickel plated)

# Series KQB2

Applicable Tube: Inch Size, Connection Thread: UNF, NPT

## Dimensions

### Male Connector: KQB2H



Applicable tube O.D. (inch)	Connection thread UNF, NPT	Model	H (Width across flat)	Note 1) $\phi D$	L	A*	M	Note 2) Effective area (mm <sup>2</sup> )	Weight (g)
$\phi 1/8"$	10-32UNF	KQB2H01-32	8	8	16.5	13.5	12	3	3.5
	1/8	KQB2H01-N01S	11.11		17.1	13.9		3.4	7.9
	1/4	KQB2H01-N02S	14.29		20.9	16.5		18	
$\phi 5/32"$	10-32UNF	KQB2H03-32	11.11	8.7	17.1	14.1	12.6	4	6.5
	1/8	KQB2H03-N01S			17	13.8		5.6	7.4
	1/4	KQB2H03-N02S			20.9	16.5		17.5	
$\phi 1/4"$	10-32UNF	KQB2H07-32	12.7	11.2	19	16	13.5	4	9
	1/8	KQB2H07-N01S			20	16.8		9.8	
	1/4	KQB2H07-N02S			20.6	16.2		13.1	15.1
	3/8	KQB2H07-N03S			23.8	19.1		31	
$\phi 5/16"$	1/8	KQB2H09-N01S	14.29	13.4	24.2	21	16.1	26.1	13.8
	1/4	KQB2H09-N02S			23.1	18.7		14.9	
	3/8	KQB2H09-N03S			24.6	19.9		28.3	
$\phi 3/8"$	1/8	KQB2H11-N01S	17.46	16	25	21.8	16.6	26.1	21.5
	1/4	KQB2H11-N02S			26.3	21.9		22.3	
	3/8	KQB2H11-N03S			23.6	18.9		41.5	24.4
	1/2	KQB2H11-N04S			28.3	21.9		55	
$\phi 1/2"$	1/4	KQB2H13-N02S	22.23	19.3	30.5	26.1	18.5	58.3	39.4
	3/8	KQB2H13-N03S			28.4	23.7		36.8	
	1/2	KQB2H13-N04S			22	22		46.1	

(10-32UNF)

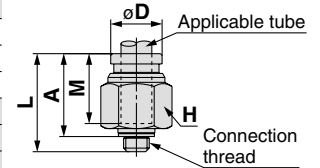

(NPT)

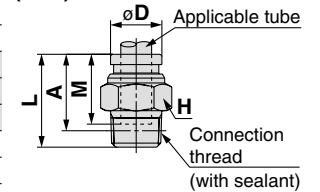

\* Reference dimensions after installation of NPT thread  
 Note 1)  $\phi D$  is maximum diameter.  
 Note 2) Value of FEP tube.

### Hexagon Socket Head Male Connector: KQB2S



Applicable tube O.D. (inch)	Connection thread UNF, NPT	Model	H (Width across flat)	Note 1) $\phi D$	L	A*	M	Note 2) Effective area (mm <sup>2</sup> )	Weight (g)	
$\phi 1/8"$	10-32UNF	KQB2S01-32	2	9	16.5	13.5	12	3	3.9	
$\phi 5/32"$	10-32UNF	KQB2S03-32	2	9	17.1	14.1	12.6	4	3.9	
	1/8	KQB2S03-N01S	2.78	11	21.4	18.2		4.1	8.9	
$\phi 1/4"$	10-32UNF	KQB2S07-32	2	12	19.5	16.5	13.5	4	7.5	
	1/8	KQB2S07-N01S	4.76		14	20.5		17.3	10	8.5
	1/4	KQB2S07-N02S				20.5		16.1	10.7	14.1
	3/8	KQB2S07-N03S				21.5		16.8	23.8	
$\phi 5/16"$	1/8	KQB2S09-N01S		5.56		14	24.7	21.5	16.1	17.2
	1/4	KQB2S09-N02S	6.35	18	23.1		18.7	23.3		13.4
	3/8	KQB2S09-N03S	6.35		18.4		24.7			
$\phi 3/8"$	1/8	KQB2S11-N01S	5.56	17	25.2	22	16.6	17.2	18.7	
	1/4	KQB2S11-N02S	6.35		18	27.1		22.7	39	22.2
	3/8	KQB2S11-N03S				23.6		18.9	25	
	1/2	KQB2S11-N04S				22		17.2	40.6	
$\phi 1/2"$	1/4	KQB2S13-N02S		8		20	30.5	26.1	18.5	46
	3/8	KQB2S13-N03S	9.53	22	29.4		24.7	60		30.4
	1/2	KQB2S13-N04S			25.5		19.1	36.5		

(10-32UNF)

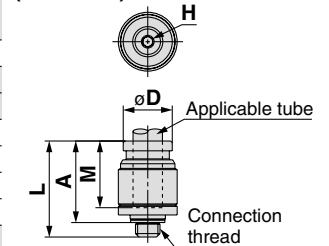

(NPT)

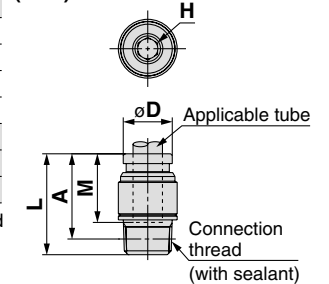

\* Reference dimensions after installation of NPT thread  
 Note 1)  $\phi D$  is maximum diameter.  
 Note 2) Value of FEP tube.

### Straight Union: KQB2H



Applicable tube O.D. (inch)	Model	$\phi D$ Note 1)	L	M	Note 2) Effective area (mm <sup>2</sup> )	Weight (g)
$\phi 1/8"$	KQB2H01-00	9	25	12	3.4	6.8
$\phi 5/32"$	KQB2H03-00	9	26.2	12.6	5.6	6.8
$\phi 1/4"$	KQB2H07-00	12	28	13.5	13.1	11.5
$\phi 5/16"$	KQB2H09-00	14	33.2	16.1	26.1	17.4
$\phi 3/8"$	KQB2H11-00	16	34.2	16.6	41.5	23.7
$\phi 1/2"$	KQB2H13-00	20	38	18.5	58.3	37

2 x Applicable tube

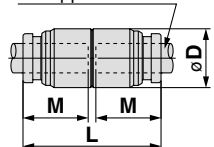

Note 1)  $\phi D$  is maximum diameter.  
 Note 2) Value of FEP tube.

# Metal One-touch Fittings *Series KQB2*

Applicable Tube: Inch Size, Connection Thread: UNF, NPT

## Dimensions

### Male Elbow: KQB2L



Applicable tube O.D. (inch)	Connection thread UNF, NPT	Model	H (Width across flat)	Note 1) $\phi D$	L1	L2	A*	M	Note 2) Effective area (mm <sup>2</sup> )	Weight (g)
$\phi 1/8"$	10-32UNF	KQB2L01-32	8	8.3	13.1	14.8	16	12	2.6	6.5
	1/8	KQB2L01-N01S	11.11		13.6	14.9	15.8		3	8.8
	1/4	KQB2L01-N02S	14.29		18.7	18.4	17.7			
$\phi 5/32"$	10-32UNF	KQB2L03-32	8	9.1	13.7	15.2	16.8	12.6	3.5	7
	1/8	KQB2L03-N01S	11.11		14.4	15.3	16.6		4.2	9.7
	1/4	KQB2L03-N02S	14.29		19.1	19.2	18.5			
$\phi 1/4"$	10-32UNF	KQB2L07-32	8	11.7	14.7	16.5	19.3	13.5	3.5	9.1
	1/8	KQB2L07-N01S	11.11		15.9	16.6	19.2		11.4	11.4
	1/4	KQB2L07-N02S	14.29		20.4	21.8	20.3		33.7	
	3/8	KQB2L07-N03S	17.46		22.2	23.3	16.1		21.6	21.9
$\phi 5/16"$	1/8	KQB2L09-N01S	12.7	13.7	18.6	18.3	21.9	16.1	21.6	15.8
	1/4	KQB2L09-N02S	14.29		19.1	21.5	23.9		21.9	
	3/8	KQB2L09-N03S	17.46		23.3	25.4	35			
$\phi 3/8"$	1/8	KQB2L11-N01S	12.7	16	20	19.4	24.2	16.6	21.6	20.5
	1/4	KQB2L11-N02S	14.29		21	22.6	26.2		23.9	
	3/8	KQB2L11-N03S	17.46		24.4	27.7	35.2		35.8	
$\phi 1/2"$	1/4	KQB2L13-N02S	14.29	19.6	22.7	24.4	29.8	18.5	50.2	30.1
	3/8	KQB2L13-N03S	17.46		23.7	26.1	31.2		37.9	
	1/2	KQB2L13-N04S	22.23		29.9	33.3	63.8			

(10-32UNF)

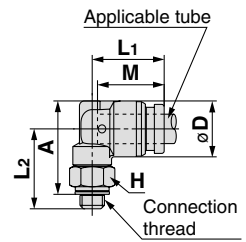

(NPT)

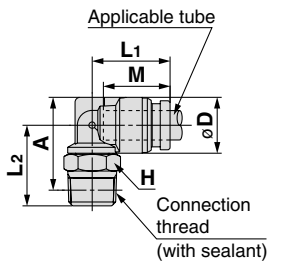

\* Reference dimensions after installation of NPT thread  
 Note 1)  $\phi D$  is maximum diameter.  
 Note 2) Value of FEP tube.

### Male Branch Tee: KQB2T



Applicable tube O.D. (inch)	Connection thread UNF, NPT	Model	H (Width across flat)	Note 1) $\phi D$	L1	L2	A*	M	Note 2) Effective area (mm <sup>2</sup> )	Weight (g)
$\phi 1/8"$	10-32UNF	KQB2T01-32	8	8.3	13.1	14.8	16	12	3.2	8.2
	1/8	KQB2T01-N01S	11.11		13.6	14.9	15.8		3.4	10.6
	1/4	KQB2T01-N02S	14.29		18.7	18.4	19.5			
$\phi 5/32"$	10-32UNF	KQB2T03-32	8	9.1	13.7	15.2	16.8	12.6	4.5	9.1
	1/8	KQB2T03-N01S	11.11		14.4	15.3	16.6		6	11.6
	1/4	KQB2T03-N02S	14.29		19.1	19.2	20.5			
$\phi 1/4"$	10-32UNF	KQB2T07-32	8	11.7	14.7	16.5	19.3	13.5	4.5	12.3
	1/8	KQB2T07-N01S	11.11		15.9	16.6	19.2		13.9	14.9
	1/4	KQB2T07-N02S	14.29		20.4	21.8	23.8			
	3/8	KQB2T07-N03S	17.46		22.2	23.3	37.1			
$\phi 5/16"$	1/8	KQB2T09-N01S	12.7	13.7	18.6	18.3	21.9	16.1	26.3	21.2
	1/4	KQB2T09-N02S	14.29		19.1	21.5	23.9		27.1	
	3/8	KQB2T09-N03S	17.46		23.3	25.4	40.3			
$\phi 3/8"$	1/8	KQB2T11-N01S	12.7	16	20	19.4	24.2	16.6	40.8	28.1
	1/4	KQB2T11-N02S	14.29		21	22.6	26.2		31.1	
	3/8	KQB2T11-N03S	17.46		24.4	27.7	43.1			
$\phi 1/2"$	1/4	KQB2T13-N02S	14.29	19.6	22.7	24.4	29.8	18.5	57.2	41.8
	3/8	KQB2T13-N03S	17.46		23.7	26.1	31.2		49	
	1/2	KQB2T13-N04S	22.23		29.9	33.3	74.9			

(10-32UNF)

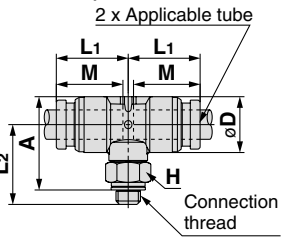

(NPT)

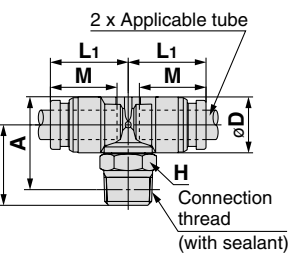

\* Reference dimensions after installation of NPT thread  
 Note 1)  $\phi D$  is maximum diameter.  
 Note 2) Value of FEP tube.

### Union Elbow: KQB2L



Applicable tube O.D. (inch)	Model	Note 1) $\phi D$	L	A	Q	M	$\phi N$	$\phi O$	Note 2) Effective area (mm <sup>2</sup> )	Weight (g)
$\phi 1/8"$	KQB2L01-00	8.3	13.6	19.3	2.9	12	3.2	5.6	3	6.3
$\phi 5/32"$	KQB2L03-00	9.1	14.6	20.5	3.1	12.6	3.2	5.6	4.2	7.4
$\phi 1/4"$	KQB2L07-00	11.7	16.7	23.2	3.7	13.5	3.2	5.6	11.4	11.5
$\phi 5/16"$	KQB2L09-00	13.7	20.1	29.1	5	16.1	4.2	8	21.6	20.2
$\phi 3/8"$	KQB2L11-00	16	21.4	31.1	5.7	16.6	4.2	8	35.2	28.2
$\phi 1/2"$	KQB2L13-00	19.6	24.9	35.3	6.4	18.5	4.2	8	50.2	41.7

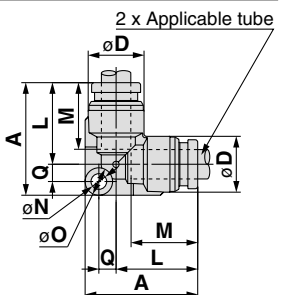

Note 1)  $\phi D$  is maximum diameter.  
 Note 2) Value of FEP tube.

# Series KQB2

Applicable Tube: Inch Size, Connection Thread: UNF, NPT

## Dimensions

### Bulkhead Union: KQB2E



Applicable tube O.D. (inch)	Model	T (UNF)	H (Width across flat)	L	Mounting hole	M	Note 2) Effective area (mm <sup>2</sup> )	Weight (g)
ø1/8"	KQB2E01-00	7/16-20UNF	14.29	34.2	12.5	12	3.4	21.8
ø5/32"	KQB2E03-00	7/16-20UNF	14.29	34.4	12.5	12.6	5.6	21.6
ø1/4"	KQB2E07-00	1/2-20UNF	17.46	36.2	14	13.5	13.1	30.2
ø5/16"	KQB2E09-00	5/8-18UNF	22.23	41.2	17	16.1	26.1	43.9
ø3/8"	KQB2E11-00	3/4-16UNF	22.23	42.4	20.5	16.6	41.5	64.2
ø1/2"	KQB2E13-00	7/8-14UNF	25.4	47	23.5	18.5	58.3	94.2

Note) Value of FEP tube.

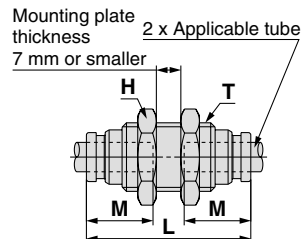

### Union Tee: KQB2T



Applicable tube O.D. (inch)	Model	Note 1) øD	L	A	Q	M	øN	øO	Note 2) Effective area (mm <sup>2</sup> )	Weight (g)
ø1/8"	KQB2T01-00	8.3	13.6	20.5	4.1	12	3.2	5.6	3.4	7.9
ø5/32"	KQB2T03-00	9.1	14.6	21.8	4.4	12.6	3.2	5.6	6.4	9.5
ø1/4"	KQB2T07-00	11.7	16.7	24.7	5.2	13.5	3.2	5.6	13.4	14.7
ø5/16"	KQB2T09-00	13.7	20.1	31.1	7	16.1	4.2	8	25.6	24.4
ø3/8"	KQB2T11-00	16	21.4	33.4	8	16.6	4.2	8	40	34.7
ø1/2"	KQB2T13-00	19.6	24.9	37.9	9	18.5	4.2	8	57.4	52.3

Note 1) øD is maximum diameter.  
Note 2) Value of FEP tube.

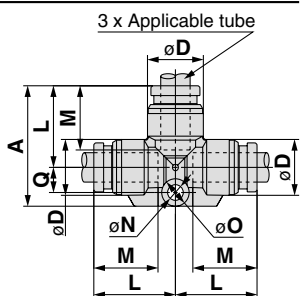

### Union "Y": KQB2U



Applicable tube O.D. (inch)	Model	Note 1) øD	W	L1	L2	P	M	øN	øO	Note 2) Effective area (mm <sup>2</sup> )	Weight (g)
ø1/8"	KQB2U01-00	8.3	16.4	29	11	8.1	12	3.2	5.6	3.4	9.2
ø5/32"	KQB2U03-00	9.1	18.2	30.4	11.3	9.1	12.6	3.2	5.6	4.2	11.1
ø1/4"	KQB2U07-00	11.7	23.9	34.5	12.1	12.2	13.5	3.2	5.6	13.4	19.6
ø5/16"	KQB2U09-00	13.7	28.3	40.1	14.1	14.6	16.1	4.2	8	25.6	29.7
ø3/8"	KQB2U11-00	16	33.2	42.2	14	17.2	16.6	4.2	8	40	43.1
ø1/2"	KQB2U13-00	19.6	40.2	47.3	15.8	20.6	18.5	4.2	8	57.4	66.4

Note 1) øD is maximum diameter.  
Note 2) Value of FEP tube.

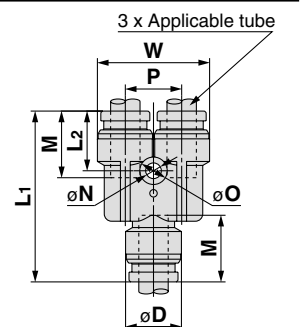

### Different Diameter Tee: KQB2T



Applicable tube O.D. (inch)	Model	Note 1) øD1	Note 1) øD2	L1	L2	L3	Q	M1	M2	øN	øO	Note 2) Effective area (mm <sup>2</sup> )	Weight (g)
ø1/8" ø5/32"	KQB2T01-03	9.1	8.3	14.2	14.1	21.1	4.1	12.6	12	3.2	5.6	3.8	8.5
ø5/32" ø1/4"	KQB2T03-07	11.7	9.1	15.5	15.9	22.7	4.4	13.5	12.6	3.2	5.6	7.1	11.7
ø1/4" ø5/16"	KQB2T07-09	13.7	11.7	19.3	17.6	29.6	6.3	16.1	13.5	4.2	8	16.4	20.2
ø5/16" ø3/8"	KQB2T09-11	16	13.7	20.6	21	31.7	7.1	16.6	16.1	4.2	8	36	28.9
ø3/8" ø1/2"	KQB2T11-13	19.6	16	23.3	23	35.4	8.1	18.5	16.6	4.2	8	56	41.8

Note 1) øD1, øD2 are maximum diameters.  
Note 2) Value of FEP tube.

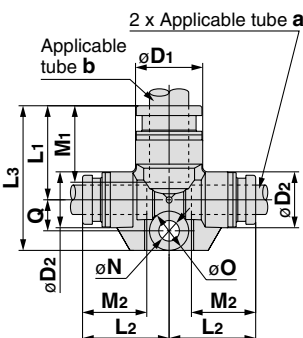

### Plug-in Reducer: KQB2R



Applicable tube O.D. (inch)	Applicable fitting size ød	Model	Note 1) øD	L	A	M	Note 2) Effective area (mm <sup>2</sup> )	Weight (g)
ø1/8"	ø5/32"	KQB2R01-03	9	32.9	20.3	12	3.4	4.9
ø5/32"	ø1/4"	KQB2R03-07	9	33.7	20.2	12.6	5.6	7.4
ø1/4"	ø5/16"	KQB2R07-09	12	38.4	22.3	13.5	13.1	12.5
ø5/16"	ø3/8"	KQB2R09-11	14	41.6	25	16.1	26.1	17.7
ø3/8"	ø1/2"	KQB2R11-13	17	39.8	21.3	16.6	41.5	24.7

Note 1) øD is maximum diameter.  
Note 2) Value of FEP tube.

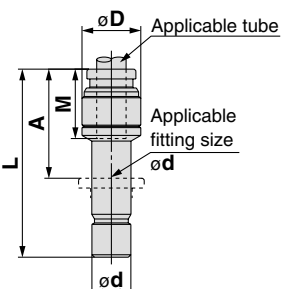

## Dimensions

### Different Diameter Straight: KQB2H



Applicable tube O.D. (inch)		Model	øD <sup>Note 1)</sup>	L	M <sub>1</sub>	M <sub>2</sub>	Note 2) Effective area (mm <sup>2</sup> )	Weight (g)
a	b							
ø1/8"	ø5/32"	KQB2H01-03	9	25.6	12	12.6	3.4	6.8
ø5/32"	ø1/4"	KQB2H03-07	12	27.1	12.6	13.5	5.6	11.9
ø1/4"	ø5/16"	KQB2H07-09	14	30.6	13.5	16.1	13.1	16.8
ø5/16"	ø3/8"	KQB2H09-11	16	33.7	16.1	16.6	26.1	23.9
ø3/8"	ø1/2"	KQB2H11-13	20	36.1	16.6	18.5	41.5	38.8

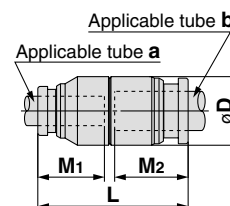

Note 1) øD is maximum diameter.  
Note 2) Value of FEP tube.

### Different Diameter Union "Y": KQB2U



Applicable tube O.D. (inch)		Model	Note 1) øD	L <sub>1</sub>	L <sub>2</sub>	P	W	M <sub>1</sub>	M <sub>2</sub>	øN	øO	Note 2) Effective area (mm <sup>2</sup> )	Weight (g)
a	b												
ø1/8"	ø5/32"	KQB2U01-03	9.1	27	10.8	8.1	16.4	12	12.6	3.2	5.6	3.2	8.5
ø5/32"	ø1/4"	KQB2U03-07	11.7	28.8	11.4	9.1	18.2	12.6	13.5	3.2	5.6	4.2	11.8
ø1/4"	ø5/16"	KQB2U07-09	13.7	33.8	12	12.2	23.9	13.5	16.1	4.2	8	13.4	20
ø5/16"	ø3/8"	KQB2U09-11	16	38.3	13.8	14.6	28.3	16.1	16.6	4.2	8	25.6	31
ø3/8"	ø1/2"	KQB2U11-13	19.6	40.5	13.7	17.2	33.2	16.6	18.5	4.2	8	40	45

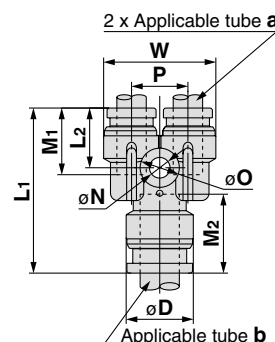

Note 1) øD is maximum diameter.  
Note 2) Value of FEP tube.

### Bulkhead Connector: KQB2E



Applicable tube O.D. (inch)	Connection thread NPT	Model	T (UNF)	Width across flat		L <sub>1</sub>	L <sub>2</sub>	Mounting hole	M	Note Effective area (mm <sup>2</sup> )	Weight (g)
				H <sub>1</sub>	H <sub>2</sub>						
ø1/8"	1/4	KQB2E01-N02	7/16-20UNF	17.46	14.29	32.8	15.3	12.5	12	3.4	34.1
ø5/32"	1/4	KQB2E03-N02	7/16-20UNF	17.46	14.29	32.6	15.3	12.5	12.6	5.6	33.5
ø1/4"	1/4	KQB2E07-N02	1/2-20UNF	17.46	17.46	33.1	14.8	14	13.5	13.1	36.5
ø5/16"	3/8	KQB2E09-N03	5/8-18UNF	22.23	22.23	35.8	15.1	17	16.1	26.1	56.1
ø3/8"	3/8	KQB2E11-N03	3/4-16UNF	22.23	22.23	35.2	13.7	20.5	16.6	41.5	62.9
ø1/2"	3/8	KQB2E13-N03	7/8-14UNF	23.81	25.4	34.6	11	23.5	18.5	58.3	76.6
	1/2	KQB2E13-N04				42.2	18.6				80.2

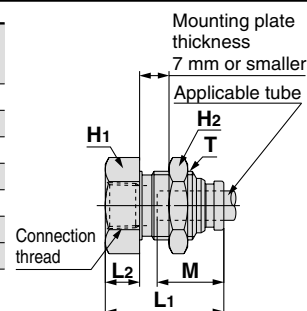

Note) Value of FEP tube.

### Extended Male Elbow: KQB2W



Applicable tube O.D. (inch)	Connection thread NPT	Model	H (Width across flat)	Note 1) øD	L <sub>1</sub>	L <sub>2</sub>	A*	M	Note 2) Effective area (mm <sup>2</sup> )	Weight (g)	
											ø1/8"
	1/4	KQB2W01-N02S	14.29	35.4	35.1	37.3					
ø5/32"	1/8	KQB2W03-N01S	11.11	9.1	14.4	32	33.3	12.6	4	20.3	
		1/4	KQB2W03-N02S			14.29	35.8			35.9	38.2
ø1/4"	1/8	KQB2W07-N01S	11.11	11.7	15.9	33.3	35.9	13.5	10.9	22.1	
		1/4	KQB2W07-N02S			14.29	37.1			38.5	39.9
		3/8	KQB2W07-N03S			17.46	38.9			40	65.6
ø5/16"	1/8	KQB2W09-N01S	12.7	13.7	18.6	34.7	38.3	16.1	20.5	30.4	
		1/4	KQB2W09-N02S			14.29	40.2			42.6	41.6
		3/8	KQB2W09-N03S			17.46	42			44.1	68.5
ø3/8"	1/4	KQB2W11-N02S	14.29	16	21	47.2	50.8	16.6	33.5	44.9	
		3/8	KQB2W11-N03S			17.46	45.4			48.7	67.8
		1/2	KQB2W11-N04S			22.23	49.2			50.8	124.2
ø1/2"	1/4	KQB2W13-N02S	14.29	19.6	23.7	22.7	49	18.5	47.7	51.1	
		3/8	KQB2W13-N03S			17.46	50.7			55.8	66
		1/2	KQB2W13-N04S			22.23	54.5			57.9	125.9

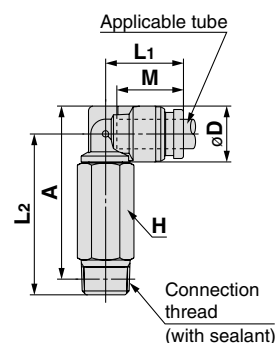

\* Reference dimensions after installation of NPT thread  
Note 1) øD is maximum diameter.  
Note 2) Value of FEP tube.

# Series KQB2

Applicable Tube: Inch Size, Connection Thread: UNF, NPT

## Dimensions

### Female Connector: KQB2F



Applicable tube O.D. (inch)	Connection thread NPT	Model	H (Width across flat)	Note 1) $\phi D$	L1	L2	M	Note 2) Effective area (mm <sup>2</sup> )	Weight (g)
$\phi 1/8$ "	1/8	KQB2F01-N01	12.7	8	24.1	10.4	12	3.4	11.3
	1/4	KQB2F01-N02	17.46		29.1	13.7			25.4
$\phi 5/32$ "	1/8	KQB2F03-N01	12.7	8.7	24.6	10.5	12.6	5.6	11.8
	1/4	KQB2F03-N02	17.46		29.6	13.8			25.9
$\phi 1/4$ "	1/8	KQB2F07-N01	12.7	11.2	25	10.7	13.5	13.1	13
	1/4	KQB2F07-N02	17.46		30	14.1			27.5
	3/8	KQB2F07-N03	22.23		31.2	14.6			41.1
$\phi 5/16$ "	1/8	KQB2F09-N01	14.29	13.4	27.2	10.3	16.1	26.1	18.8
	1/4	KQB2F09-N02	17.46		32.2	14.3			30.1
	3/8	KQB2F09-N03	22.23		33.4	14.8			44
$\phi 3/8$ "	1/4	KQB2F11-N02	17.46	16	32.1	14.4	16.6	41.5	32.9
	3/8	KQB2F11-N03	22.23		33.3	14.9			47
	1/2	KQB2F11-N04	23.81		38.6	18.6			50.4
$\phi 1/2$ "	3/8	KQB2F13-N03	22.23	19.3	34.6	14.7	18.5	58.3	51.3
	1/2	KQB2F13-N04	23.81		39.9	18.8			55.1

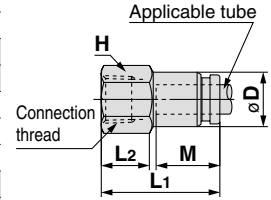

Note 1)  $\phi D$  is maximum diameter.  
Note 2) Value of FEP tube.

### Plug: KQB2P



Applicable fitting size $\phi d$	Model	$\phi D$	L	A	Weight (g)
$\phi 1/8$ "	KQB2P-01	5	28.9	16.9	2.8
$\phi 5/32$ "	KQB2P-03	6	29.6	17	4.3
$\phi 1/4$ "	KQB2P-07	8	30.3	16.8	9.4
$\phi 5/16$ "	KQB2P-09	10	33.7	17.6	16.3
$\phi 3/8$ "	KQB2P-11	11	34.1	17.5	22.2
$\phi 1/2$ "	KQB2P-13	14	36.4	17.9	40.7

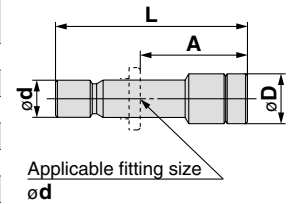



# Metal One-touch Fittings

Applicable Tube: Metric Size, Connection Thread: G

## Series **KQB2**

RoHS



### Applicable Tube

Tube material	FEP, PFA, Nylon, Soft nylon <sup>Note 1)</sup> , Polyurethane, Polyolefin
Tube O.D.	ø4, ø6, ø8, ø10, ø12, ø16

### Specifications

Fluid	Air, Water
Operating pressure range <sup>Note 2)</sup>	-100 kPa to 1 MPa <sup>Note 3)</sup>
Proof pressure	3.0 MPa
Ambient and fluid temperature <sup>Note 4)</sup>	-5 to 150°C (No freezing) <sup>Note 3)</sup>
Lubricant	Grease-free specification
Seal on the threads	With sealant

Note 1) For soft nylon tube, water cannot be used.

Note 2) Avoid using in a vacuum holding application such as a leak tester, since there is leakage.

Note 3) Check the operating pressure range and operating temperature range of the tube.

Note 4) It is recommended that you use the inner sleeve in the following conditions:

- When using in an environment where the fluid temperature changes drastically.
- When using at a high temperature.

#### \* Temperature Condition of Mounting the Inner Sleeve

Tube	Temperature
FEP tube/TH series	80°C or more
PFA tube/TL series	120°C or more

### Spare Parts

Description	Tube O.D.	Part no.	Material
Bulkhead nut	ø4	<b>KQB223-P01</b>	C3604 (Electroless nickel plated)
	ø6	<b>KQB206-P01</b>	
	ø8	<b>KQB208-P01</b>	
	ø10	<b>KQB210-P01</b>	
	ø12	<b>KQB212-P01</b>	
	ø16	<b>KQB216-P01</b>	

Description	Thread size	Part no.	Material
G thread O-ring	G1/8	<b>KQB2-G01</b>	Special FKM (Fluoro coated)
	G1/4	<b>KQB2-G02</b>	
	G3/8	<b>KQB2-G03</b>	
	G1/2	<b>KQB2-G04</b>	

### Cross Reference Table of the Inner Sleeve

Tube O.D.	Tube material			Applicable inner sleeve	
	TUS (Soft polyurethane)	TH/THI (FEP)	TL/TIL (PFA)	Part no.	Length
ø4	—	TH0402	—	<b>TJ-0402</b>	18
	TUS0425	TH0425	—	<b>TJ-0425</b>	18
	—	—	TL0403	<b>TJ-0403</b>	18
ø6	TUS0604	TH0604	TL0604	<b>TJ-0604</b>	19
	TUS0805	—	—	<b>TJ-0805</b>	20.5
ø8	—	TH0806	TL0806	<b>TJ-0806</b>	20.5
	TUS1065	—	—	<b>TJ-1065</b>	23
ø10	—	TH1075	—	<b>TJ-1075</b>	23
	—	TH1008	TL1008	<b>TJ-1008</b>	23
	TUS1208	—	—	<b>TJ-1208</b>	24
ø12	—	TH1209	—	<b>TJ-1209</b>	24
	—	TH1210	TL1210	<b>TJ-1210</b>	24

\* C2700 + Electroless nickel plated is used for the TJ series.

### Construction

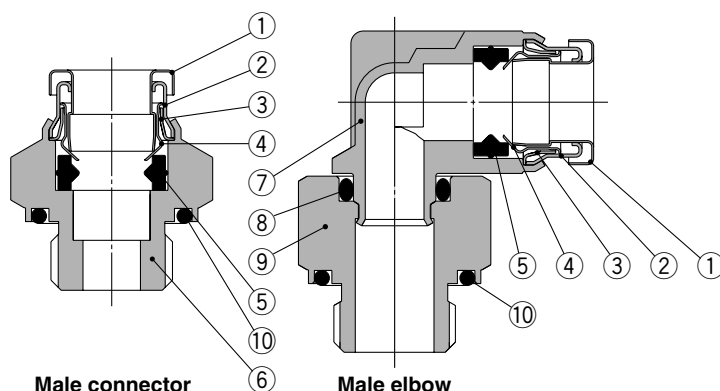

### Component Parts

No.	Description	Material
1	Release button	Stainless steel 304
2	Guide 1	Stainless steel 304
3	Guide 2	Stainless steel 304
4	Chuck	Stainless steel 304
5	Seal	Special FKM (Fluoro coated)
6	Male connector body	C3604 (Electroless nickel plated)
7	Male elbow body	Stainless steel 316
8	O-ring	Special FKM (Fluoro coated)
9	Stud	C3604 (Electroless nickel plated)
10	G thread O-ring	Special FKM (Fluoro coated)

# Series KQB2

Applicable Tube: Metric Size, Connection Thread: G

## Dimensions

### Male Connector: KQB2H



Applicable tube O.D. (mm)	Connection thread G	Model	H (Width across flat)	Note 1) $\phi D$	$\phi d$	L	A	M	Note 2) Effective area (mm <sup>2</sup> )	Weight (g)
$\phi 4$	1/8	KQB2H04-G01	14	8.7	13.8	16.6	11.1	12.6	5.6	9.2
	1/4	KQB2H04-G02	19		17.8	20.6	14.1			23.6
$\phi 6$	1/8	KQB2H06-G01	14	11.1	13.8	17.6	12.1	13.6	13.1	8.9
	1/4	KQB2H06-G02	19		17.8	20.5	14			21.6
	3/8	KQB2H06-G03	22		21.8	23.4	15.9			38.3
$\phi 8$	1/8	KQB2H08-G01	14	13.4	13.8	23.9	18.4	16.1	26.1	13.2
	1/4	KQB2H08-G02	19		17.8	21.2	14.7			19.1
	3/8	KQB2H08-G03	22		21.8	24	16.5			35.2
$\phi 10$	1/8	KQB2H10-G01	17	16.4	13.8	25.1	19.6	17	26.1	19.9
	1/4	KQB2H10-G02	19		17.8	24.9	18.4			24.8
	3/8	KQB2H10-G03	22		21.8	23.3	15.8		30.9	
	1/2	KQB2H10-G04	27		26.5	27.7	18.7		64.4	
$\phi 12$	1/4	KQB2H12-G02	19	18.5	17.8	27.7	21.2	18.6	58.3	26.3
	3/8	KQB2H12-G03	22		21.8	23.5	16			25.5
	1/2	KQB2H12-G04	27		26.5	27.9	18.9			58
$\phi 16$	3/8	KQB2H16-G03	24	24.6	21.8	31.3	23.8	20.8	81	44.5
	1/2	KQB2H16-G04	27		26.5	27.3	18.3		113	43

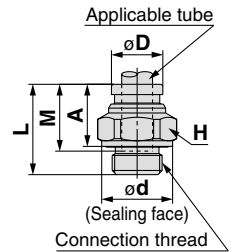

Note 1)  $\phi D$  is maximum diameter.

Note 2) Value of FEP tube.

Value of nylon tube for  $\phi 16$  only.

### Hexagon Socket Head Male Connector: KQB2S



Applicable tube O.D. (mm)	Connection thread G	Model	H (Width across flat)	Note 1) $\phi D$	$\phi d$	L	A	M	Note 2) Effective area (mm <sup>2</sup> )	Weight (g)
$\phi 4$	1/8	KQB2S04-G01	3	14	14	20.4	14.9	12.6	4.1	13.5
$\phi 6$	1/8	KQB2S06-G01	4	14	14	20.6	15.1	13.6	10	12.1
	1/4	KQB2S06-G02		18	18		14.1		10.7	19.9
$\phi 8$	1/8	KQB2S08-G01	5	14	14	23.9	18.4	16.1	17.2	12.5
	1/4	KQB2S08-G02	6	18	18	22.9	16.4		20.1	
	3/8	KQB2S08-G03		22	22	23.1	15.6		31.1	
$\phi 10$	1/8	KQB2S10-G01	5	17	14	25.1	19.6	17	17.2	18.5
	1/4	KQB2S10-G02	8	18	18	24.9	18.4		39	20.4
	3/8	KQB2S10-G03		22	22	16.5	31.2			
	1/2	KQB2S10-G04		27	26.5	15	45.3			
$\phi 12$	1/4	KQB2S12-G02		8	19	18	27.7	21.2	18.6	46
	3/8	KQB2S12-G03	10	22	22	24.9	17.4	60		27.4
	1/2	KQB2S12-G04		27	26.5	15.9	42.6			
$\phi 16$	3/8	KQB2S16-G03	10	24.6	22	31.3	23.8	20.8	81	41
	1/2	KQB2S16-G04	12	27	26.5	27.8	18.8		113	42.9

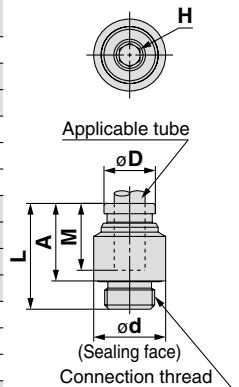

Note 1)  $\phi D$  is maximum diameter.

Note 2) Value of FEP tube.

Value of nylon tube for  $\phi 16$  only.

## Dimensions

### Male Elbow: KQB2L



Applicable tube O.D. (mm)	Connection thread G	Model	H (Width across flat)	Note 1) $\phi D$	$\phi d$	L1	L2	A	M	Note 2) Effective area (mm <sup>2</sup> )	Weight (g)
$\phi 4$	1/8	KQB2L04-G01	14	9.1	13.8	14.4	18.9	17.9	12.6	4.2	15.6
	1/4	KQB2L04-G02	19		17.8		22.3	20.3			33
$\phi 6$	1/8	KQB2L06-G01	14	11.4	13.8	15.9	20	20.2	13.6	11.4	17.2
	1/4	KQB2L06-G02	19		17.8		23.4	22.6			34.6
	3/8	KQB2L06-G03	22		21.8		25.9	24.1			54.5
$\phi 8$	1/8	KQB2L08-G01	14	13.7	13.8	18.6	21.3	22.6	16.1	21.6	20.2
	1/4	KQB2L08-G02	19		17.8		24.7	25			36
	3/8	KQB2L08-G03	22		21.8		27.2	26.5			55.6
$\phi 10$	1/8	KQB2L10-G01	14	16.6	13.8	20	22.7	25.5	17	35.2	25.7
	1/4	KQB2L10-G02	19		17.8		26.1	27.9			38.2
	3/8	KQB2L10-G03	22		21.8		28.6	29.4			56.2
	1/2	KQB2L10-G04	27		26.5		32.6	31.9			97.9
$\phi 12$	1/4	KQB2L12-G02	19	18.7	17.8	22.6	27.2	30	18.6	50.2	41.9
	3/8	KQB2L12-G03	22		21.8		29.6	31.4			54.3
	1/2	KQB2L12-G04	27		26.5		33.6	33.9			94.6
$\phi 16$	3/8	KQB2L16-G03	22	24.6	21.8	26.3	32.4	36.5	20.8	71	64.7
	1/2	KQB2L16-G04	27		26.5		27.3	36.4			39

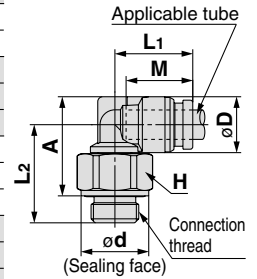

Note 1)  $\phi D$  is maximum diameter.

Note 2) Value of FEP tube.

Value of nylon tube for  $\phi 16$  only.

### Male Branch Tee: KQB2T



Applicable tube O.D. (mm)	Connection thread G	Model	H (Width across flat)	Note 1) $\phi D$	$\phi d$	L1	L2	A	M	Note 2) Effective area (mm <sup>2</sup> )	Weight (g)
$\phi 4$	1/8	KQB2T04-G01	14	9.1	13.8	14.4	18.9	17.9	12.6	6	17.5
	1/4	KQB2T04-G02	19		17.8		22.3	20.3			34.9
$\phi 6$	1/8	KQB2T06-G01	14	11.4	13.8	15.9	20	20.2	13.6	13.9	21
	1/4	KQB2T06-G02	19		17.8		23.4	22.6			38
	3/8	KQB2T06-G03	22		21.8		25.9	24.1			57.9
$\phi 8$	1/8	KQB2T08-G01	14	13.7	13.8	18.6	21.3	22.6	16.1	26.3	25.6
	1/4	KQB2T08-G02	19		17.8		24.7	25			41.2
	3/8	KQB2T08-G03	22		21.8		27.2	26.5			60.8
$\phi 10$	1/8	KQB2T10-G01	14	16.6	13.8	20	22.7	25.5	17	40.8	34
	1/4	KQB2T10-G02	19		17.8		26.1	27.9			46
	3/8	KQB2T10-G03	22		21.8		28.6	29.4			64
	1/2	KQB2T10-G04	27		26.5		32.6	31.9			105.8
$\phi 12$	1/4	KQB2T12-G02	19	18.7	17.8	22.6	27.2	30	18.6	57.2	53
	3/8	KQB2T12-G03	22		21.8		29.6	31.4			54.3
	1/2	KQB2T12-G04	27		26.5		33.6	33.9			105
$\phi 16$	3/8	KQB2T16-G03	22	24.6	21.8	26.3	32.4	36.5	20.8	71	82.2
	1/2	KQB2T16-G04	27		26.5		27.3	36.4			39

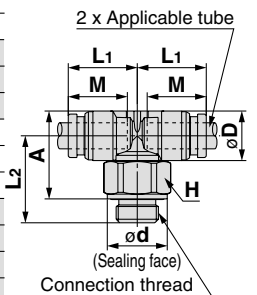

Note 1)  $\phi D$  is maximum diameter.

Note 2) Value of FEP tube.

Value of nylon tube for  $\phi 16$  only.

# Series KQB2

Applicable Tube: Metric Size, Connection Thread: G

## Dimensions

### Bulkhead Connector: KQB2E



Applicable tube O.D. (mm)	Connection thread G	Model	T (M)	Width across flat		L1	L2	Mounting hole	M	Note) Effective area (mm <sup>2</sup> )	Weight (g)
				H1	H2						
ø4	1/8	KQB2E04-G01	M10 x 1	17	12	27.1	11	11	12.6	5.6	25.1
	1/4	KQB2E04-G02		19	12	32.7	16.6				36.9
ø6	1/8	KQB2E06-G01	M14 x 1	17	17	25.5	7.4	15	13.6	13.1	26.8
	1/4	KQB2E06-G02		19		33.5	15.4				42.7
	3/8	KQB2E06-G03		24	35	16.9	62				
ø8	1/8	KQB2E08-G01	M15 x 1	17	19	27.6	8.2	16	16.1	26.1	30.4
	1/4	KQB2E08-G02		19		34.5	15.1				43.9
	3/8	KQB2E08-G03		24	36	16.6	66.2				
ø10	1/4	KQB2E10-G02	M18 x 1	19	21	33.5	13.5	19	17	41.5	46.8
	3/8	KQB2E10-G03		24		35.6	15.6				65.4
	ø12	3/8		KQB2E12-G03	M20 x 1	24	24				35.9
1/2		KQB2E12-G04	27	42.2		21		91.9			
ø16		3/8	KQB2E16-G03	M27 x 1		29	30	37.2	13.1	28	20.8
	1/2	KQB2E16-G04	43.1		19	113		128.7			

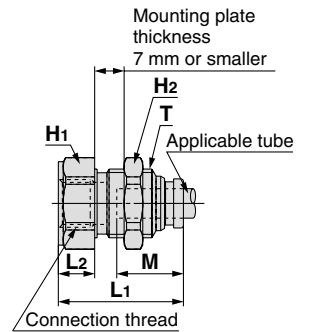

Note) Value of FEP tube.  
Value of nylon tube for ø16 only.

### Extended Male Union: KQB2W



Applicable tube O.D. (mm)	Connection thread G	Model	H (Width across flat)	Note 1) øD	ød	L1	L2	A	M	Note 2) Effective area (mm <sup>2</sup> )	Weight (g)
1/4	KQB2W04-G02	19	17.8	14.4	38.7	36.7	70.6				
ø6	1/8	KQB2W06-G01	14	11.4	13.8	15.9	36.4	36.6	13.6	10.9	36.1
	1/4	KQB2W06-G02	19		17.8		39.8	39			72.2
	3/8	KQB2W06-G03	22		21.8	42.3	40.5	106.7			
ø8	1/8	KQB2W08-G01	14	13.7	13.8	18.6	40	41.3	16.1	20.5	41.3
	1/4	KQB2W08-G02	19		17.8	19.1	43.4	43.7			76.7
	3/8	KQB2W08-G03	22		21.8	45.9	45.2	112.9			
ø10	1/4	KQB2W10-G02	19	16.6	17.8	21	49.8	51.6	17	33.5	84.8
	3/8	KQB2W10-G03	22		21.8		50.2	51			116.6
	1/2	KQB2W10-G04	27		26.5	54.2	53.5	196.6			
ø12	1/4	KQB2W12-G02	19	18.7	17.8	22.6	50.9	53.7	18.6	47.7	88.7
	3/8	KQB2W12-G03	22		21.8	23.6	53.3	55.1			111.6
	1/2	KQB2W12-G04	27		26.5	57.3	57.6	193.8			
ø16	3/8	KQB2W16-G03	22	24.6	21.8	26.3	62	66.1	20.8	71	133.6
	1/2	KQB2W16-G04	27		26.5	27.3	66	68.6			100

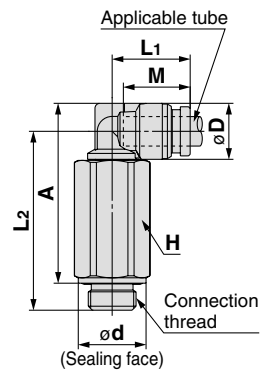

Note 1) øD is maximum diameter.  
Note 2) Value of FEP tube.  
Value of nylon tube for ø16 only.

### Female Connector: KQB2F



Applicable tube O.D. (mm)	Connection thread G	Model	H (Width across flat)	Note 1) øD	L1	L2	M	Note 2) Effective area (mm <sup>2</sup> )	Weight (g)
1/4	KQB2F04-G02	19	30.6	14.5	32				
ø6	1/8	KQB2F06-G01	17	11.1	25.5	9.7	13.6	13.1	22.6
	1/4	KQB2F06-G02	19		31.1	14.7			33
	3/8	KQB2F06-G03	24		32.6	14.6			51.1
ø8	1/8	KQB2F08-G01	17	13.4	27.6	10	16.1	26.1	25.1
	1/4	KQB2F08-G02	19		33.2	14.9			36.3
	3/8	KQB2F08-G03	24		34.6	14.7			53.8
ø10	1/4	KQB2F10-G02	19	16.4	33.5	15.2	17	41.5	39.9
	3/8	KQB2F10-G03	24		34.9	15			57.7
	1/4	KQB2F12-G02	19		34.5	15.2			41.8
ø12	3/8	KQB2F12-G03	24	18.5	35.9	15	18.6	58.3	59.7
	1/2	KQB2F12-G04	27		41.8	19.9			81.6
	ø16	3/8	KQB2F16-G03		24	24.6			37.2
1/2		KQB2F16-G04	27	43.1	20.4		113	89.1	

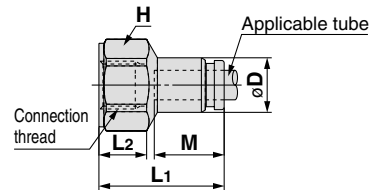

Note 1) øD is maximum diameter.  
Note 2) Value of FEP tube.  
Value of nylon tube for ø16 only.



## Series KQB2

# Specific Product Precautions

Be sure to read before handling. Refer to back cover for Safety Instructions, “Handling Precautions for SMC Products” (M-E03-3) for Fittings and Tubing Precautions.

### Selection

#### Caution

1. The surge pressure must be under the maximum operating pressure. If the surge pressure exceeds the maximum operating pressure, it will result in damage to fittings and tubes or the tube may result in being fallen out.
2. If using a fluoro resin tube in an environment where the fluid temperature changes drastically, it is recommended to use an inner sleeve. Otherwise, air leakage may occur or the tube may release from fitting due to deformation of the tube.
3. The particle generation of the KQB2 series depends on the operating conditions and operating environment. If you are concerned about the effects on machinery and equipment, check the particle generation with your machine before use.

The components of the KQB2 series may slide due to changes in the internal pressure, which may generate particles. When using male elbow, male branch tee, and extended male elbow fittings, particles may be generated by rotation for positioning after connecting.

### Mounting

#### Caution

1. The union elbow, union tee, union “Y”, different diameter tee, and different diameter union “Y” fittings should be fixed through the mounting hole.  
Otherwise, air leakage or breaking can occur due to a pulling force or moment load created by the product's weight.
2. The male elbow, male branch tee, and extended male elbow fittings can be rotated for positioning, but they cannot be used rotating.  
This will cause metal debris by wearing, which may enter the operating fluid or cause fitting damage.
3. Keep the connection part of fittings and tubes from rotating or oscillating movement.

### Installation and Removal of Tube

#### Caution

1. Installation of tube
  - 1) Grease is not used for the KQB2 series, therefore a greater insertion force is required when the tube is installed. In particular, polyurethane tube may fold when inserted due to its softness. Hold the end of the tube, and insert it all the way in slowly and securely. Refer to dimension “M” in the dimension drawings for guidance on the insertion depth of tube.
2. Removal of tube
  - 1) For tube used at a high temperature or for an extended period of time, there is a possibility that it will not fit into a one-touch fitting again due to an enlarged O.D. Dispose of the tube and replace it with a new one.

### G Thread Fittings

#### Caution

1. The standard thread torques of the fittings are as shown in the below table.



Connection thread size	Proper tightening torque N·m
G1/8	2.9 to 3.2
G1/4	5.7 to 6.3
G3/8	9.5 to 10.5
G1/2	14.3 to 15.8





## Safety Instructions

These safety instructions are intended to prevent hazardous situations and/or equipment damage. These instructions indicate the level of potential hazard with the labels of “**Caution**,” “**Warning**” or “**Danger**.” They are all important notes for safety and must be followed in addition to International Standards (ISO/IEC)\*1, and other safety regulations.

-  **Caution:** **Caution** indicates a hazard with a low level of risk which, if not avoided, could result in minor or moderate injury.
-  **Warning:** **Warning** indicates a hazard with a medium level of risk which, if not avoided, could result in death or serious injury.
-  **Danger:** **Danger** indicates a hazard with a high level of risk which, if not avoided, will result in death or serious injury.

- \*1) ISO 4414: Pneumatic fluid power – General rules relating to systems.
- ISO 4413: Hydraulic fluid power – General rules relating to systems.
- IEC 60204-1: Safety of machinery – Electrical equipment of machines. (Part 1: General requirements)
- ISO 10218-1: Manipulating industrial robots - Safety. etc.

### Warning

- 1. The compatibility of the product is the responsibility of the person who designs the equipment or decides its specifications.**  
Since the product specified here is used under various operating conditions, its compatibility with specific equipment must be decided by the person who designs the equipment or decides its specifications based on necessary analysis and test results. The expected performance and safety assurance of the equipment will be the responsibility of the person who has determined its compatibility with the product. This person should also continuously review all specifications of the product referring to its latest catalogue information, with a view to giving due consideration to any possibility of equipment failure when configuring the equipment.
- 2. Only personnel with appropriate training should operate machinery and equipment.**  
The product specified here may become unsafe if handled incorrectly. The assembly, operation and maintenance of machines or equipment including our products must be performed by an operator who is appropriately trained and experienced.
- 3. Do not service or attempt to remove product and machinery/equipment until safety is confirmed.**
  1. The inspection and maintenance of machinery/equipment should only be performed after measures to prevent falling or runaway of the driven objects have been confirmed.
  2. When the product is to be removed, confirm that the safety measures as mentioned above are implemented and the power from any appropriate source is cut, and read and understand the specific product precautions of all relevant products carefully.
  3. Before machinery/equipment is restarted, take measures to prevent unexpected operation and malfunction.
- 4. Contact SMC beforehand and take special consideration of safety measures if the product is to be used in any of the following conditions.**
  1. Conditions and environments outside of the given specifications, or use outdoors or in a place exposed to direct sunlight.
  2. Installation on equipment in conjunction with atomic energy, railways, air navigation, space, shipping, vehicles, military, medical treatment, combustion and recreation, or equipment in contact with food and beverages, emergency stop circuits, clutch and brake circuits in press applications, safety equipment or other applications unsuitable for the standard specifications described in the product catalogue.
  3. An application which could have negative effects on people, property, or animals requiring special safety analysis.
  4. Use in an interlock circuit, which requires the provision of double interlock for possible failure by using a mechanical protective function, and periodical checks to confirm proper operation.

### Caution

- 1. The product is provided for use in manufacturing industries.**  
The product herein described is basically provided for peaceful use in manufacturing industries.  
If considering using the product in other industries, consult SMC beforehand and exchange specifications or a contract if necessary.  
If anything is unclear, contact your nearest sales branch.

## Limited warranty and Disclaimer/ Compliance Requirements

The product used is subject to the following “Limited warranty and Disclaimer” and “Compliance Requirements”.  
Read and accept them before using the product.

### Limited warranty and Disclaimer

1. The warranty period of the product is 1 year in service or 1.5 years after the product is delivered.\*2)  
Also, the product may have specified durability, running distance or replacement parts. Please consult your nearest sales branch.
2. For any failure or damage reported within the warranty period which is clearly our responsibility, a replacement product or necessary parts will be provided.  
This limited warranty applies only to our product independently, and not to any other damage incurred due to the failure of the product.
3. Prior to using SMC products, please read and understand the warranty terms and disclaimers noted in the specified catalogue for the particular products.

\*2) Vacuum pads are excluded from this 1 year warranty.

A vacuum pad is a consumable part, so it is warranted for a year after it is delivered. Also, even within the warranty period, the wear of a product due to the use of the vacuum pad or failure due to the deterioration of rubber material are not covered by the limited warranty.

### Compliance Requirements

1. The use of SMC products with production equipment for the manufacture of weapons of mass destruction (WMD) or any other weapon is strictly prohibited.
2. The exports of SMC products or technology from one country to another are governed by the relevant security laws and regulations of the countries involved in the transaction. Prior to the shipment of a SMC product to another country, assure that all local rules governing that export are known and followed.

## Safety Instructions

Be sure to read “Handling Precautions for SMC Products” (M-E03-3) before using.

### SMC Corporation (Europe)

Austria	☎ +43 2262622800	www.smc.at	office@smc.at
Belgium	☎ +32 (0)33551464	www.smcpnematics.be	info@smcpnematics.be
Bulgaria	☎ +359 29744492	www.smc.bg	office@smc.bg
Croatia	☎ +385 13776674	www.smc.hr	office@smc.hr
Czech Republic	☎ +420 541424611	www.smc.cz	office@smc.cz
Denmark	☎ +45 70252900	www.smc.dk.com	smc@smcdk.com
Estonia	☎ +372 6510370	www.smcpnematics.ee	smc@smcpnematics.ee
Finland	☎ +358 207513513	www.smc.fi	smcfi@smc.fi
France	☎ +33 (0)164761000	www.smc-france.fr	contact@smc-france.fr
Germany	☎ +49 (0)61034020	www.smc-pneumatik.de	info@smc-pneumatik.de
Greece	☎ +30 210 2717265	www.smchellas.gr	sales@smchellas.gr
Hungary	☎ +36 23511390	www.smc.hu	office@smc.hu
Ireland	☎ +353 (0)14039000	www.smcpnematics.ie	sales@smcpnematics.ie
Italy	☎ +39 (0)292711	www.smcitalia.it	mailbox@smcitalia.it
Latvia	☎ +371 67817700	www.smc.lv	info@smclv.lv

Lithuania	☎ +370 5 2308118	www.smclt.lt	info@smclt.lt
Netherlands	☎ +31 (0)205318888	www.smcpnematics.nl	info@smcpnematics.nl
Norway	☎ +47 67129020	www.smc-norge.no	post@smc-norge.no
Poland	☎ +48 222119600	www.smc.pl	office@smc.pl
Portugal	☎ +351 226166570	www.smc.eu	postpt@smc.smces.es
Romania	☎ +40 213205111	www.smcromania.ro	smcromania@smcromania.ro
Russia	☎ +7 8127185445	www.smc-pneumatik.ru	info@smc-pneumatik.ru
Slovakia	☎ +421 413213212	www.smc.sk	office@smc.sk
Slovenia	☎ +386 73885412	www.smc.si	office@smc.si
Spain	☎ +34 945184100	www.smc.eu	post@smc.smces.es
Sweden	☎ +46 (0)86031200	www.smc.nu	post@smcpnematics.se
Switzerland	☎ +41 (0)523963131	www.smc.ch	info@smc.ch
Turkey	☎ +90 (0)2124440762	www.entek.com.tr	smc@entek.com.tr
UK	☎ +44 (0)845 121 5122	www.smcpnematics.co.uk	sales@smcpnematics.co.uk